



 JURALCO

JURALCO AMPLIMESH[®] SECURITY DOOR AND WINDOW SYSTEMS

ISSUE 3-23 v1

Juralco Amplimesh® Security Door and Window System

Juralco Aluminium Building Products Ltd designs and distributes specialist aluminium joinery systems through a national network of franchised fabricators and agents.

For more than 25 years we have been at the forefront of specialist aluminium door and window products suitable for New Zealand joinery and building methods. Our comprehensive product range includes security and insect screens, balustrades and gates, shutters and awnings, shower screens, wardrobe doors and organisers and internal doors.

Juralco Amplimesh® Security doors and windows incorporates proprietary security grille and extrusions and are suitable for use in a wide range of installations including residential, commercial, school door and window applications, hotel, bar, club, vehicle and shop window protection screens. Doors are available in both Sliding and Hinged configurations and Windows in Sliding, Hinged and Fixed configurations. All are custom-made in a variety of powder-coat and anodised finishes and incorporate complimentary hardware and optional insect mesh systems



Index

Type	Pages	Description	Use the Bookmarks  List to jump to selected pages
General	3 - 4	General descriptions of Insect Window and Door types. Amplimesh security grille types.	
Windows	5 - 9	Shows Hinged and Sliding Security windows. Extrusions, components and cutting allowances	
Doors, Hinged	10 - 19	Shows Hinged Security doors. Extrusions, components and cutting allowances.	
	20 - 21	Worksheet - Single and Double Hinged Doors	
Doors, Sliding	22 - 32	Shows Sliding Security doors. Extrusions, components and cutting allowances	
	33 - 35	Worksheet - Single and Double Sliding Doors	
Mesh Fitting	36	Shows Insect Mesh options	
Powder coat	37	Instructions for the care of Powder coated surfaces	

Important information - Powder Coating systems.

Powdercoat Systems The new standard Dulux powder coating system used by Juralco is Duralloy Plus®. Also Duralloy® and Duratec®. Juralco Powder coated prices are for Duralloy Plus® and Duralloy® (same pricing). Duratec® prices on application. The following specs apply to Building Exteriors.

- Dulux Duralloy Plus® powder coating systems are suitable for properties greater than 10m from high tide level. Residential and Light commercial buildings, 3 levels max. Warranty 15 yrs
- Dulux Duratec® powder coating systems are suitable for properties greater than 10m from high tide level. All Residential and Commercial buildings. Warranty 25 yrs.

Attachment to structures A PVC Tape or similar material spacer must be used to separate powder coated aluminium items from all concrete and steel structures. Failure to do so can lead to the chemicals in the structure affecting the powder coating, leading to corrosion.

Swimming Pools The chlorinated water in swimming pools can cause the deterioration of powder coated surfaces, leading to corrosion of the underlying surface. It is recommended that Powder coated surfaces be 1200mm min from a pool.

Care The Dulux powder coating warranty period is conditional upon the surface being maintained in accordance with the Dulux 'Care and Maintenance Instructions'. Download from Dulux or refer to the back page of this manual.

All pages © Copyright Juralco Aluminium Building Products Ltd, 2023

Juralco Amplimesh® Security Door and Window Systems - Grille Types

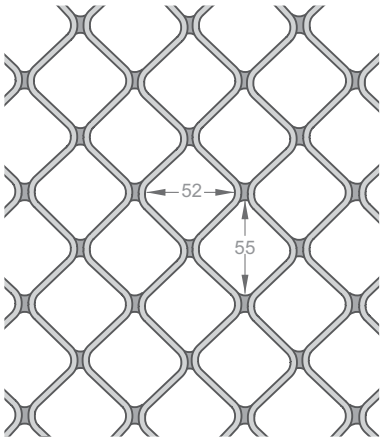

Amplimesh® 125 Grille
 Type 125A
 Width x Height 7500 x 2000

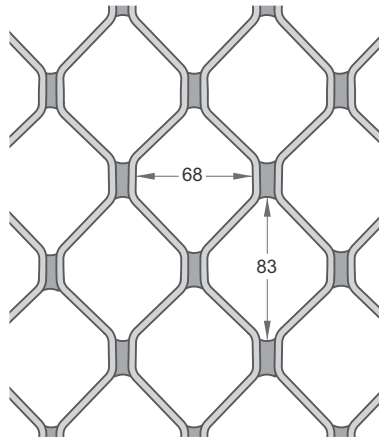
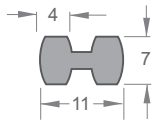

Amplimesh® 103 Grille
 Type 103A, 103C, 103D
 Width x Height 750 x 2000 or 4000, 900 x 2000 or 4000, 1250 x 2000 or 4000

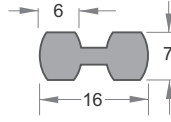

Important Note:
 Amplimesh® Security Grilles 103 and 125 are suitable for Door and Window applications. Both comply with AS 2803.

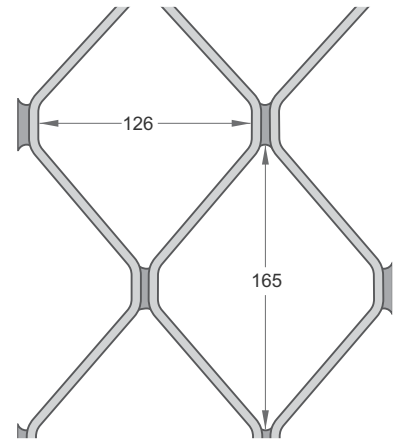

Amplimesh® 106 Grille
 Type 106D
 Width x Height 1250 x 2450

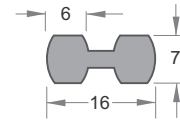

Important Note:
 Amplimesh® Security Grille 106 is not for Door applications, but is suitable for Commercial Window protection.

Amplimesh® Panel Sizes

Sheet Part No	Width mm	Length mm
J103A/2000	750	2000
J103C/2000	900	2000
J103D/2000	1250	2000
J103A/4000	750	4000
J103C/4000	900	4000
J103D/4000	1250	4000

Approx Max Door Frame Size

Width, max mm	Height, max mm
870	2120
1020	2120
1320	2120
870	4120
1020	4120
1320	4120

To conform to AS5039-2008 the Mesh must be rivetted to the Frame.
 This is best done on site in case the door needs altering slightly out of square.

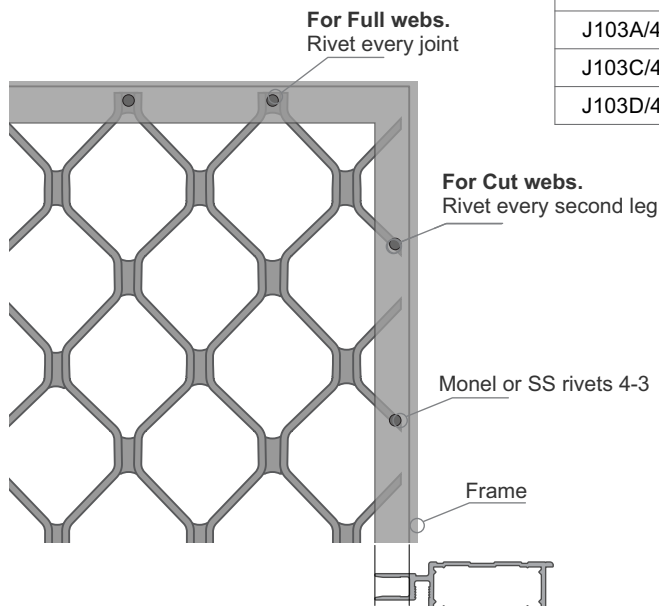

Juralco Amplimesh® Security Door and Window Systems - General Descriptions

Security Windows

- Juralco offers a wide range of options covering either hinged or sliding windows.
- Choice of 2 x Amplimesh grille designs
- All doors are constructed from our propriety range of aluminium extrusions.
- Choice of 3 x different Insect screen types fibreglass, pet proof and privacy.
- Available in a range of powdercoat colours to your design or natural anodised.
- A variety of Hardware to suit your security requirements.

Fixed Window Panels
H max = 2800mm, W max 2400mm

Hinged Window Panels
H max = 1500mm, W max 1200mm

Sliding Window Panels
H max = 1500mm, W max 1200mm

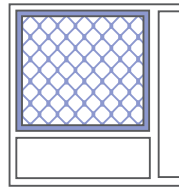

Fixed Windows

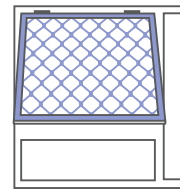

Hinged Windows

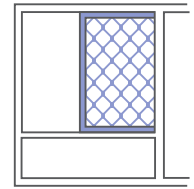

Sliding Windows

To conform to AS5039-2008
the Mesh must be rivetted to the Frame (see p3)

Single Awning



Can be top hinged,
fixed or lift in and out.
Inside fixing only.

Awning with Fixed Panel

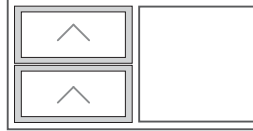

Sliding Screen covering both
sashes or top hinged covering
one sash. Inside fixing only.

Double Hung

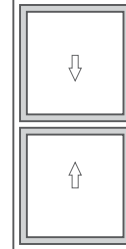

Fixed or lift in and out.
Preferably on the outside.

Fixed Panel

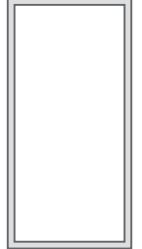

Fixed or side hinged
either
inside or out.

Sliding with Fixed Panel

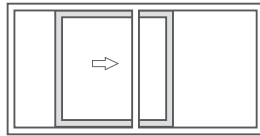

Either sliding on the inside
or fixed on the outside

Casement

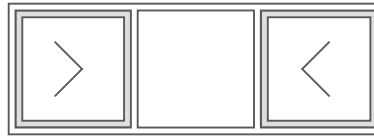

Side hinged, sliding or fixed. Inside fixing only.

Security Doors

- Juralco offers a wide range of options covering either hinged or sliding doors.
- 1 x Amplimesh grille design
- All doors are constructed from our propriety range of aluminium extrusions.
- Choice of 3 x different Insect screen types fibreglass, pet proof and privacy.
- Available in a range of powdercoat colours to your design or natural anodised.
- A variety of Hardware to suit your security requirements.

Hinged Door Panels
H max = 2400mm, W max 1200mm

Sliding Door Panels
H max = 2400mm, W max 1500mm

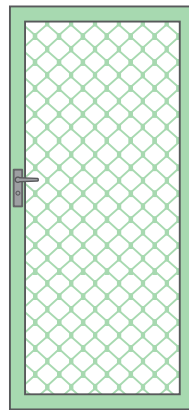

Hinged Door

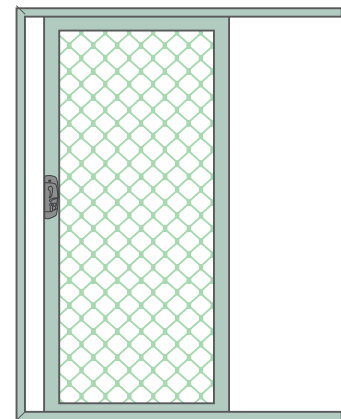

Sliding Door

To conform to AS5039-2008
the Mesh must be rivetted to the Frame (see p3)

Timber Doors

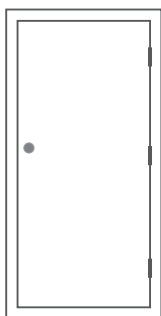

Most Security Doors will
fit within the timber jamb.

Aluminium Doors

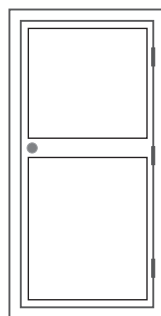

Security Doors will
require an adaptor extrusion
to clear the door handle.

Timber or Aluminium Doors
with Glass Sidelight

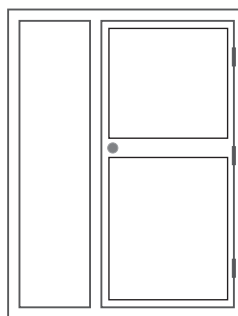

Will normally require building out
the door mullion with dressed timber .

Timber or Aluminium Doors
with Two Glass Sidelights

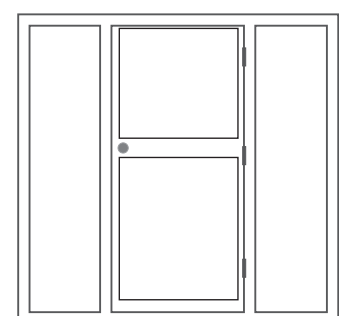

Will normally require building out
the both door mullions with dressed timber .



JURALCO

www.juralco.co.nz ph (09) 478 8018

Juralco Amplimesh® Security Door and Window Systems

Issue 3-23 v1
Page 4

Juralco Amplimesh® Security Door and Window Systems - Window Extrusions

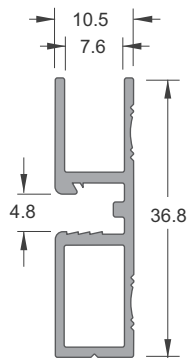

**AMPLIMESH
SECURITY WINDOW
FRAME
J5663/5**

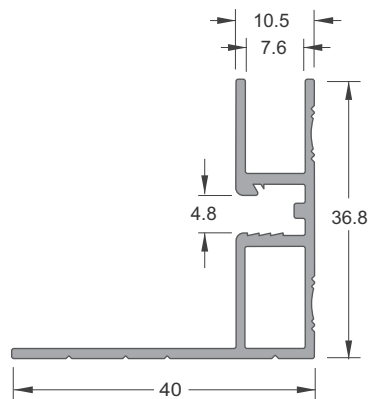

**AMPLIMESH
SECURITY WINDOW
FRAME ANGLE
J6179/5**

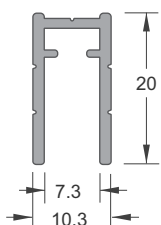

**7mm GRILLE
AMPLIMESH CAPPING
CHANNEL
J3414/5**

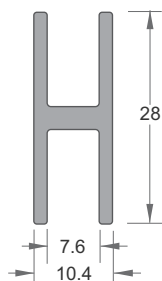

**7mm GRILLE JOINER
J3515/5**

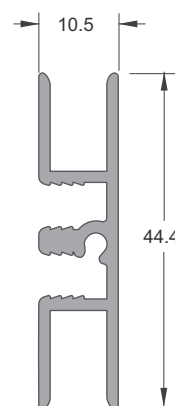

**7mm GRILLE SECURITY
WINDOW
FRAME JOINER
J3516/5
(With insect spline groove)**

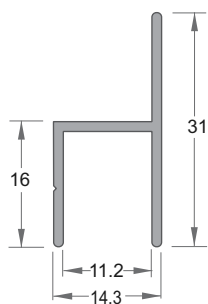

**SLIDING WINDOW
TOP CHANNEL
(with Leg)
J5775/5**

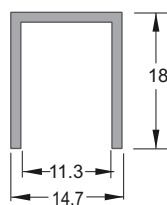

**SLIDING WINDOW
TOP CHANNEL
J5773/5**

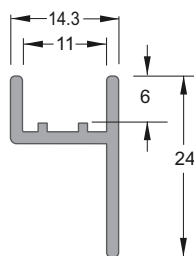

**SLIDING WINDOW
BOTTOM CHANNEL
(with Leg)
J5774/5**

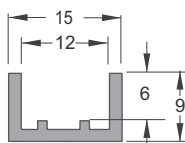

**SLIDING WINDOW
BOTTOM CHANNEL
J5772/5**

Juralco Amplimesh® Security Door and Window Systems - Window Components

Butt Hinge 65mm
JC240

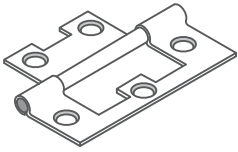

Corner Stake
JC212

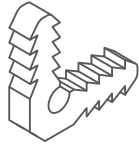

Nylon Runner
JC284



Mohair Strip
JC225

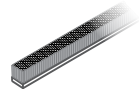

350mt Roll

Mighty Strong
Window Presslock
JJM194B

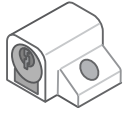

Black only

Whitco Window Presslock
JJH22023 (B or W)

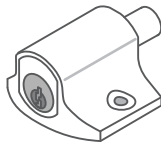

Black or White

Whitco Mini
Window Bolt 40mm
JJH22033 (B or W)

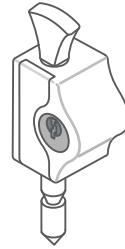

Black or White

Whitco Sliding
Window Presslock
JJH22013B

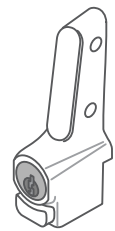

Black only

Whitco Window Multi Bolt
JJH22053

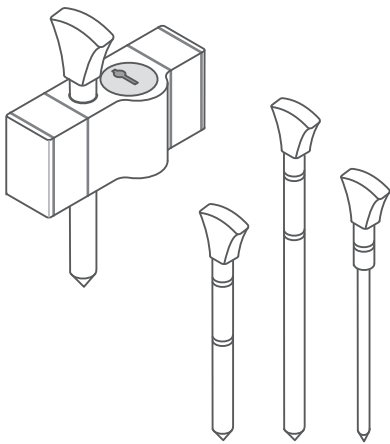

Black or White

Includes 3x Door Bolts

Juralco Amplimesh® Security Door and Window Systems - Window Details

Ten Point Check List - Security Window Measuring

- 1 - Decide what type of screen would be suitable for this installation.
i.e. Sliding, Top Hinged, Side Hinged, Fixed or Lift In and Out.
- 2 - Measure opening height and width according to the type of screen to be fitted.
- 3 - Note the most suitable frame for the screen i.e. 5663-6179, 3717-7133, 9517.
- 4 - Check distance of protruding handles or window stays to make sure security screen has enough fixing surface.
- 5 - Check existing blinds, curtains, pelmets and drapes to see that security screen will not catch if and when opened.
- 6 - Decide on suitable lock. Refer Juralco Security Hardware & Components Price List.
- 7 - Check and see if customer requires insect mesh as well as security mesh.
- 8 - Discuss colour finish and type of Amplimesh panel required.
- 9 - Note any add ons - timber packers, build out angles, sliding channels.
- 10 - Don't leave the site until you are 100% sure the unit you have detailed will work.

Amplimesh Windows, Fixed - Reveal or Face Fix

This configuration can be used to add Security to any window opening. The Frame and Security Panel are lightweight and suitable for all environments.

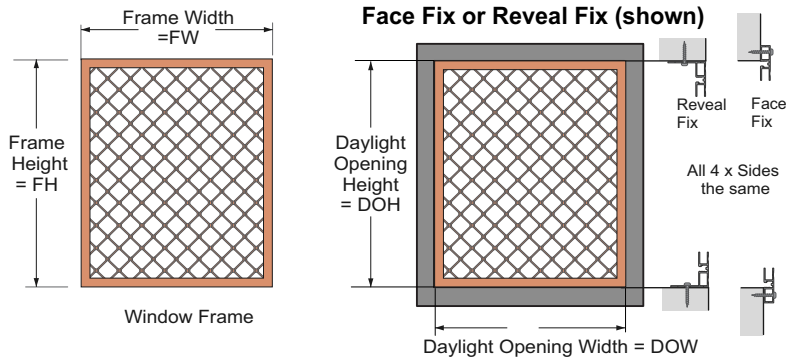

Window Frame
J5663

Window Frame with
Angle J6719

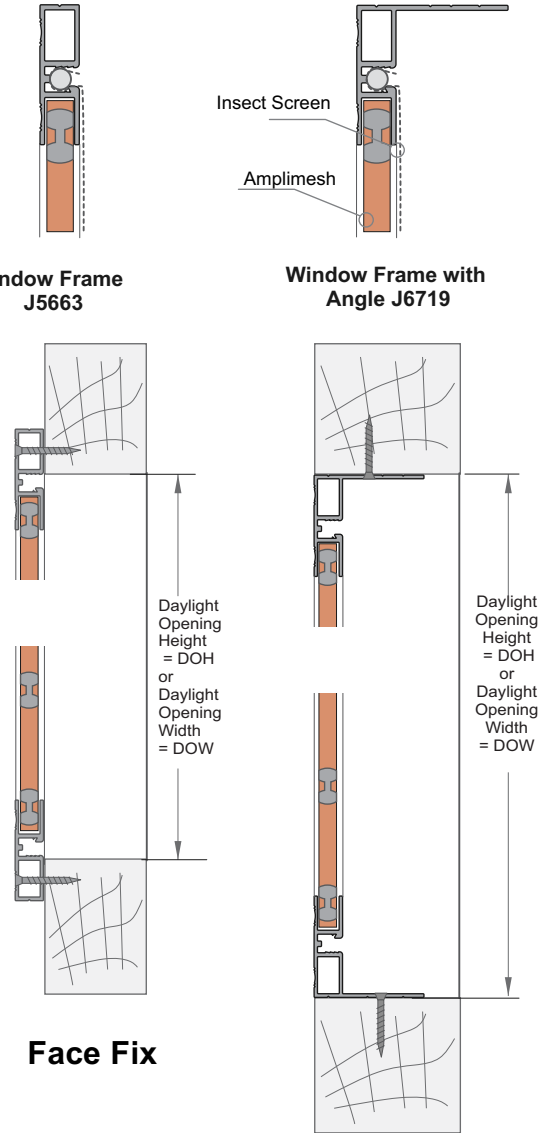

Face Fix

Reveal Fix

AMPLIMESH SINGLE FIXED WINDOWS

	FACE FIX	Part	Cutting Calc	No
1	Window Frame Height FH	J5663	$(DOH + 33) = FH$	2
2	Window Frame Width FW	J5663	$(DOW + 33) = FW$	2

	REVEAL FIX	Part	Cutting Calc	No
1	Window Frame Height FH	J6719	$(DOH - 2) = FH$	2
2	Window Frame Width FW	J6719	$(DOW - 2) = FW$	2

Select FH, FW from Face or Reveal Mounts

1	Amplimesh Panel Height	J103....	$FH - 50$	1
2a	Insect Mesh (Fibreglass) Height	JPSFG/...	FH	1
2b	Insect Spline Height	JC228	FH	2
1	Amplimesh Panel Width	J103...	$FW - 50$	1
2a	Insect Mesh (Fibreglass) Width	JPSFG/...	FW	1
2b	Insect Spline Width	JC228	FW	2

Components - always needed		Part	No
1	Window Frame Corner Stake	JC212	4

Cutting calculations - These are a guide only, confirm before cutting
Strongly Recommended - Allow +30mm per cut to allow for Trimming/Mitre cuts and on site adjustment

Juralco Amplimesh® Security Door and Window Systems - Window Details

Amplimesh Windows - Hinged Reveal Fix only

This configuration can be used to add Security to **any window opening**.
The Fame and Security Panel are lightweight and suitable for all environments.



Window Frame
J5663

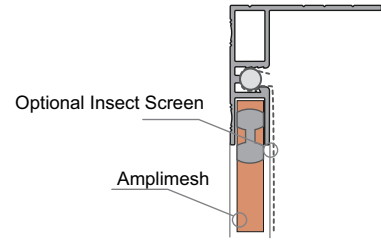

Window Frame with
Angle J6719

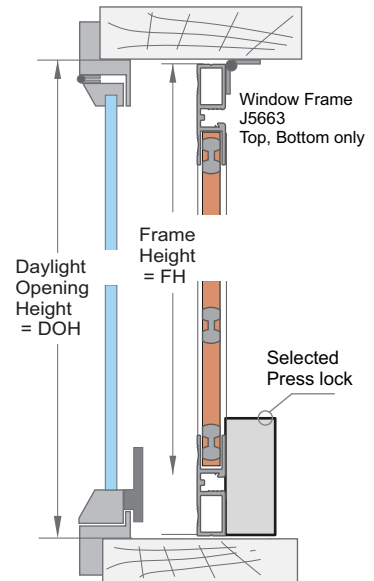
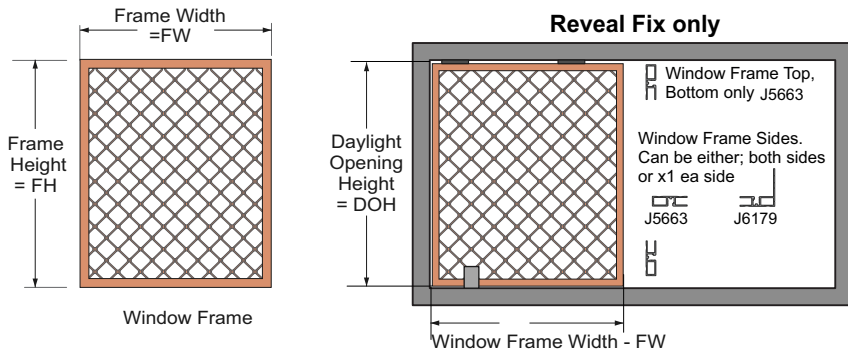

Reveal Fix only

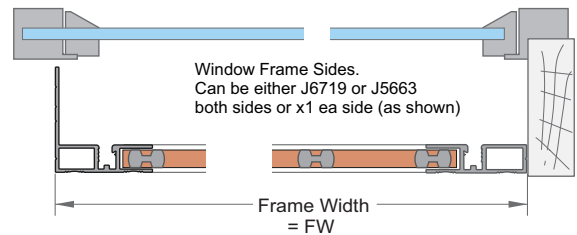

AMPLIMESH HINGED SINGLE WINDOWS

	REVEAL FIX	Part	Cutting Calc	No
1	Window Frame Height FH	J5663 or J6719	$(DOH - 10) = FH$	2
2	Window Frame Width FW	J5663	Enter FW	2

1	Amplimesh Panel Height	J103....	$FH - 50$	1
2a	Insect Mesh (Fibreglass) Height	JPSFG/...	FH	1
2b	Insect Spline Height	JC228	FH	2
1	Amplimesh Panel Width	J103...	$FW - 50$	1
2a	Insect Mesh (Fibreglass) Width	JPSFG/...	FW	1
2b	Insect Spline Width	JC228	FW	2

Components - always needed		Part	No
1	Window Frame Corner Stake	JC212	4
2	Mighty Strong Hinge 65mm	JC240	2
Select 1 x appropriate Window Lock			
1	Mighty Strong Presslock (Black)	JJM194B	1
2	Whitco Presslock (Black or White)	JJH22023	
3	Whitco Minibolt (Black or White)	JJH22033	

Cutting calculations - These are a guide only, confirm before cutting
Strongly Recommended - Allow +30mm per cut to allow for Trimming/Mitre cuts and on site adjustment

Juralco Amplimesh® Security Door and Window Systems - Window Details

Amplimesh Windows - Sliding Reveal or Face Fix

This configuration can be used to add Security to **any window opening**. The Fame and Security Panel are lightweight and suitable for all environments.

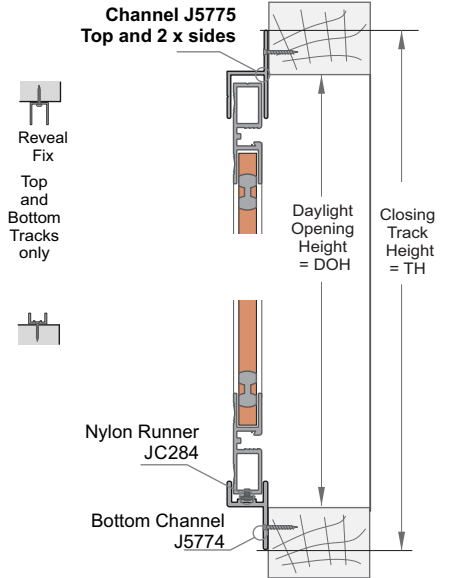
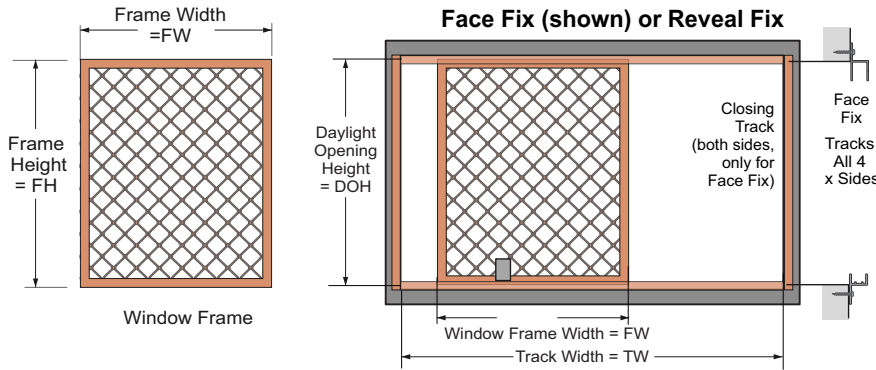
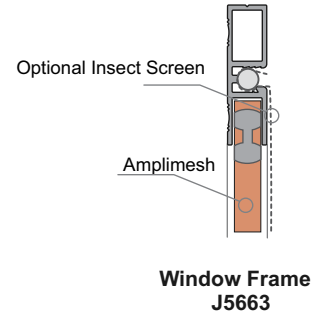
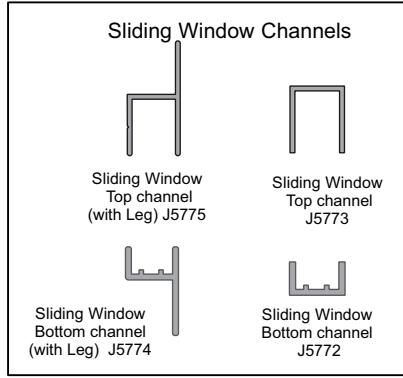

Face Fix

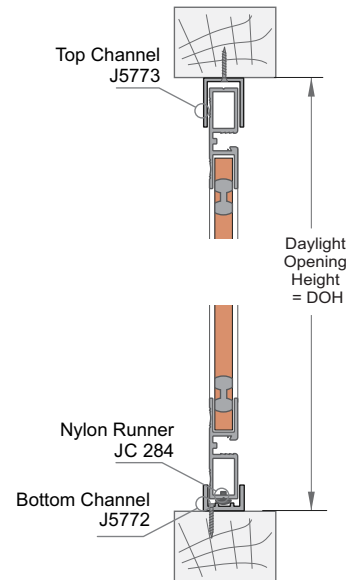

Reveal Fix

AMPLIMESH SINGLE SLIDING WINDOWS

FACE FIX				
	Part	Cutting Calc	No	
1	Window Frame Height FH	J5663 (DOH - 6) = FH	2	
2	Closing Track Height TH	J5775 (DOH + 30) = TH	2	
3	Window Frame Width FW	J5663 Enter FW	2	
4	Track Widths TW	J5775, J5774 Enter TW	1ea	

REVEAL FIX				
	Part	Cutting Calc	No	
1	Window Frame Height FH	J5663 (DOH - 6) = FH	2	
2	Window Frame Width FW	J5663 Enter FW	2	
3	Track Widths TW	J5773, J5772 Enter TW	1ea	

Select FH, FW from Face or Reveal Mounts

1	Amplimesh Panel Height	J103...	FH - 50	1
2a	Insect Mesh (Fibreglass) Height	JPSFG/...	FH	1
2b	Insect Spline Height	JC228	FH	2
1	Amplimesh Panel Width	J103...	FW - 50	1
2a	Insect Mesh (Fibreglass) Width	JPSFG/...	FW	1
2b	Insect Spline Width	JC228	FW	2

Components - always needed		Part	No
1	Window Frame Corner Stake	JC212	4
2	Nylon Runner	JC284	4
Select 1 x appropriate Window Lock			
1	Whitco Sliding Presslock (Black)	JJH22013B	1
2	Mighty Strong Presslock (Black)	JJM194B	
3	Whitco Window Presslock (Black or White)	JJH22023	
4	Whitco Minibolt (Black or White)	JJH22033	

Cutting calculations - These are a guide only, confirm before cutting
 Strongly Recommended - Allow +30mm per cut to allow for Trimming/Mitre cuts and on site adjustment

Juralco Amplimesh® Security Door and Window Systems - Hinged Door Extrusions

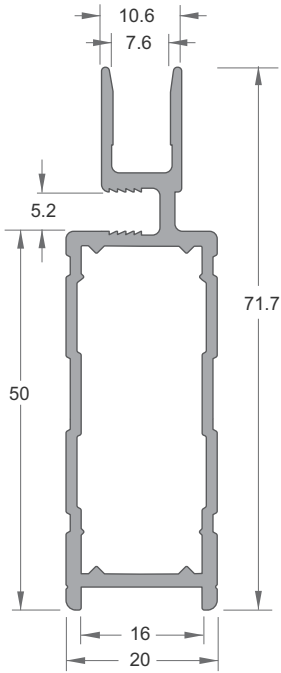

**DOOR FRAME
J9295**

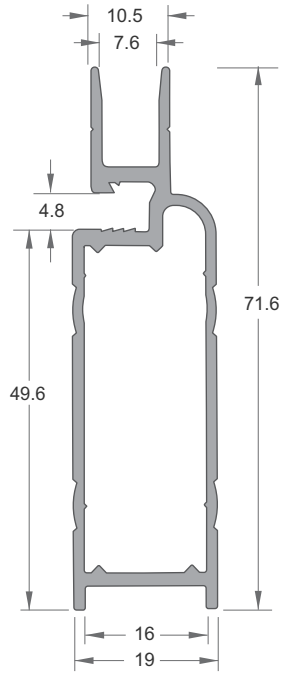

**DOOR FRAME
J6661**

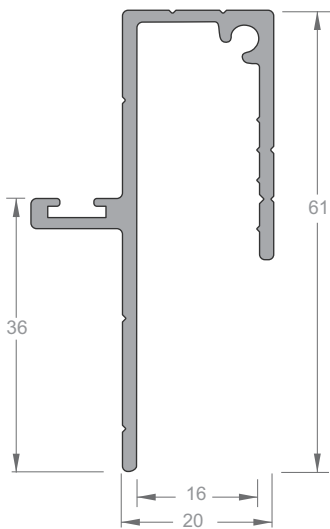

**HINGED DOOR
ADAPTOR
J7467**

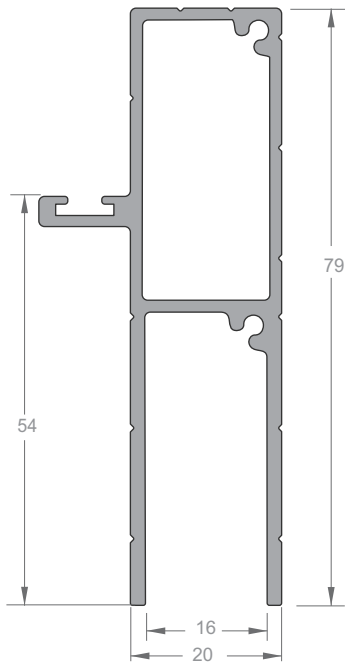

**HINGED DOOR
BUILDOUT 54mm
J7465**

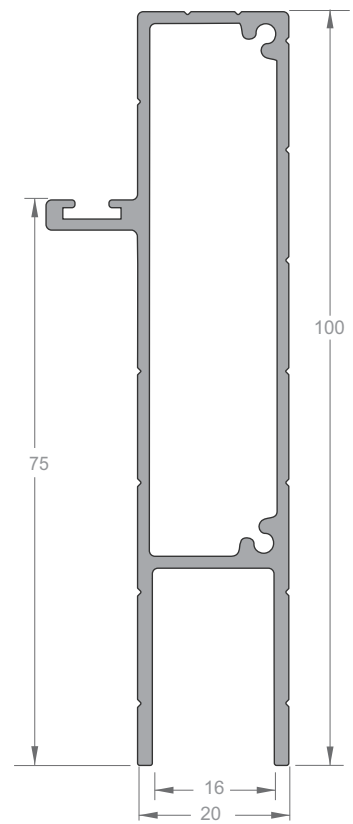

**HINGED DOOR
BUILDOUT 75mm
J7466**

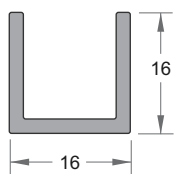

**BASE CHANNEL
J7470**

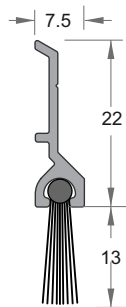

**DOOR SEAL
(with 13mm Mohair)
JA186**

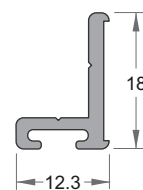

**CLOSING ANGLE
J3737**

Juralco Amplimesh® Security Door and Window Systems - Hinged Door Components

Hinged Door Locks Elegance + Elegance HD14

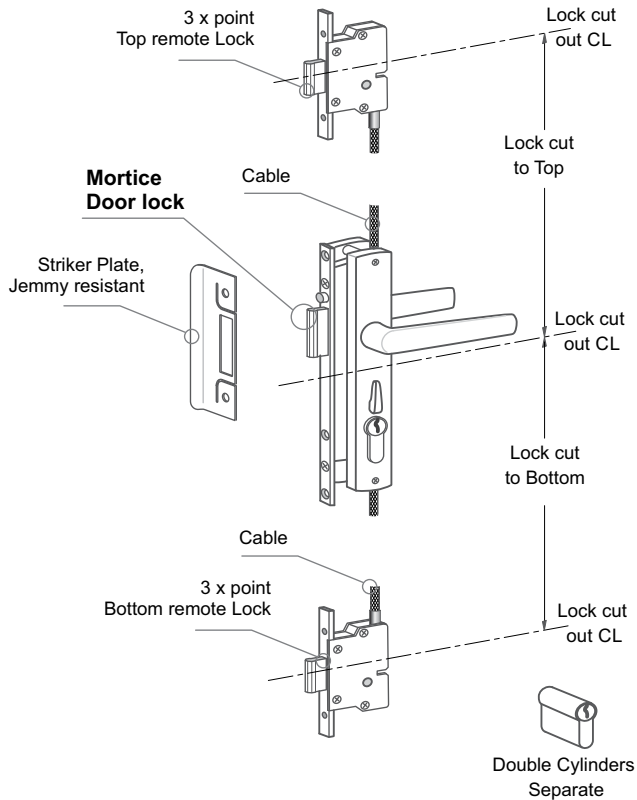

Hinged Security Doors

- a - This lock can be used for RH or LH hinged doors
- b - Standard, Mortice, Centre only or Three point Lock Cable Drive, Top and Bottom Remote locks
- c - Available in three different center line combinations

Refer to instructions in kit for more information

Hinged Door Locks Ultimate + Ultimate HD 16

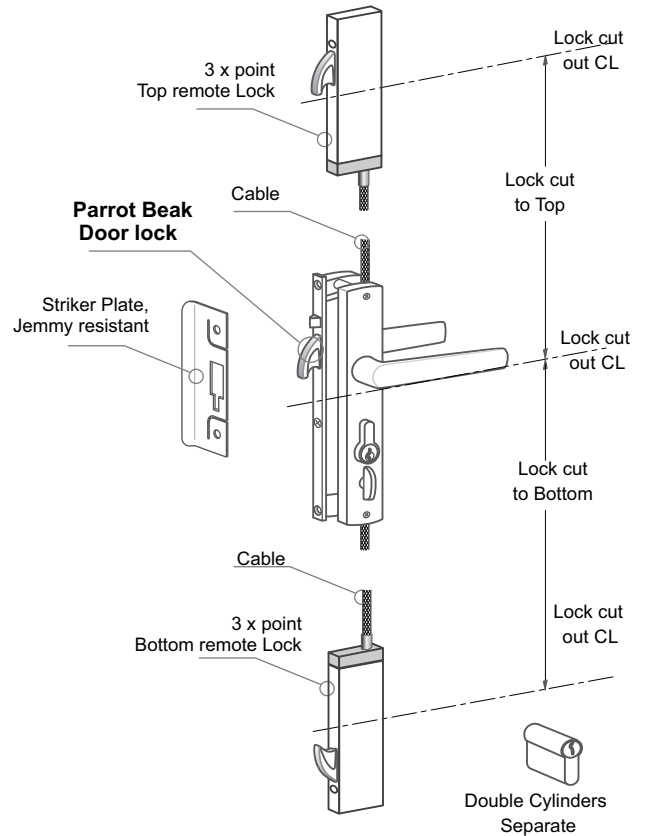

Hinged Security Doors

- a - This lock can be used for RH or LH hinged doors
- b - Standard, Parrot beak, Centre only or Three point Lock Cable Drive, Top and Bottom Remote locks
- c - Available in three different center line combinations

Refer to instructions in kit for more information

Hinge

JC242

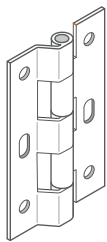

Available Zinc plated steel, or SS

Staking Angle, Heavy Duty

JC216

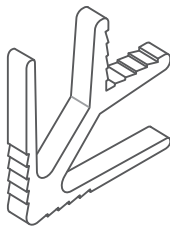

Mohair Strip

JC225

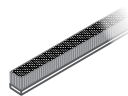

350mt Roll

Door Closer

JJMDCH

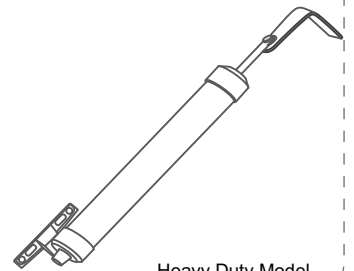

Heavy Duty Model

Clearguard Plug

JCGTape

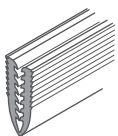

4mt Lengths

Whitco Flush Bolt

JJH203817
1 x 150mm Rod

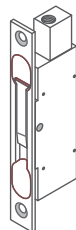

For Double Hinged Doors - Black only

Ausloc Double Flush Bolt

2 x 1500mm Rods

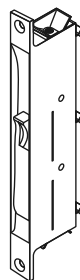

For Double Hinged Doors - Black only

Snib Protector



JD100POLY
230mm H
x 110mm W

JD100
290mm H
x 144mm W
White or SCC

Juralco Amplimesh® Security Door and Window Systems - Hinged Door, General

Security Hinged Door Recommendations

- 1 - **Frame** - Heavy duty Door Frame PN 9295
- 2 - **Corner Joints** - Heavy duty PN JC 216 .
After assembling the frame the door should stay completely rigid.
- 3 - **Security Grille** - Amplimesh Security Grille103
- 4 - **Locks** - We recommend an Austral Elegance or Austral Ultimate for higher security.
Kits can be added to convert to 3 point locks.
- 5 - **Hinges** - Security screen doors should be fitted with inter-locking security hinges to prevent removal of the door if the hinge pin is removed.
Hinge pins should be peened at the top and bottom
- 6 - **Fasteners** - High strength, stainless steel rivets to be used for fastening corner stakes, hinges and grille to frame.
Size and application of rivets must allow no movement between parts. Non-corrosive 8-gauge fixing screws can be used as an alternative. The heads of all fasteners must be concealed to restrict access from outside when the door is closed.

For reveal mounting only, on the interior or exterior.
Insect screen options.

Note - This configuration can be used to add security to any Door opening. The frame and security grille are lightweight and suitable for all environments.

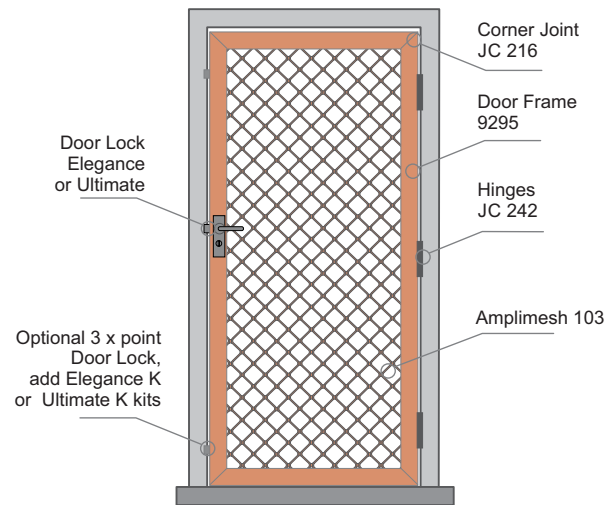

To conform to AS5039-2008
the Mesh must be rivetted to the Frame (see p4)

Security Hinged Door Measuring

Check list for measuring up a Security Door

- 1 - **Door frame opening width** to be measured at 3 points, A, B and C. Record smallest measurement as the daylight width opening. Check for any bow in jambs.
- 2 - **Door frame opening height** to be measured at 2 points, D and E. Record smallest measurement as the daylight height opening. Check for any bow in sill or step.
- 3 - **Door Frame Diagonals F and G** to be measured to assess squareness of frame.
- 4 - **Height of furniture H**, on main door to be measured to ensure no interference with security door handles.
Also check on space between doors for handle clearance.
Check protruding measurement of existing door handle to see there is still enough space (25mm) to fit the security door within the jamb. Note most aluminium hinged glass doors require a 7465 adaptor build out section.
- 5 - **Check** which way door is to be hung, RH or LH. Note most suitable side for security door to be hinged. Generally it is hinged the same as the ensitu door but in some applications access is better if the security door is hinged opposite to ensitu door.
- 6 - **Check** thickness of stop bead T. Stepped striker plates and hinge leaves have a step dimension of 12mm to mate with the stop bead. If the door does not have a suitably positioned stop bead then a 3737 closing angle will be required.
- 7 - **Check** around doorway to see there are no protruding fuse boxes or hanging lights to stop security door from fully opening.
- 8 - **Check** to see that there are no door knockers or door bells that may require relocating before security door could be installed.
- 9 - **Check** that the security door will clear the door mat (mainly a problem in concrete floor / aluminium door installations).
- 10 - **Check** colour finish of security door and type of Amplimesh panel required.
- 11 - **Check** for any extras - automatic door closer, cat door, triple door lock....

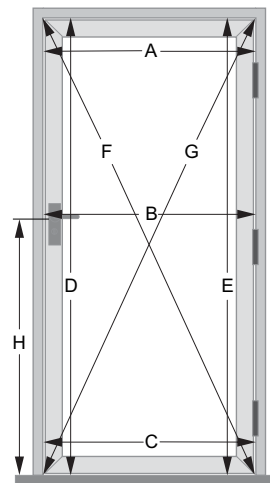

Door - 7 x Measure points

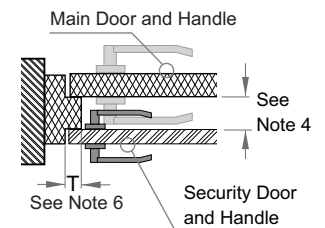
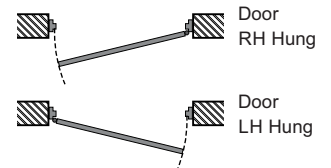

Juralco Amplimesh® Security Door and Window Systems - Hinged Door, Cutting, Assembly

Amplimesh Single Hinged Door
Reveal Mount

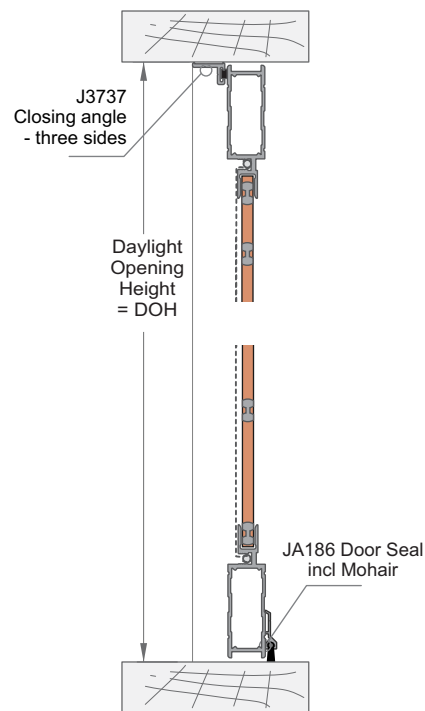
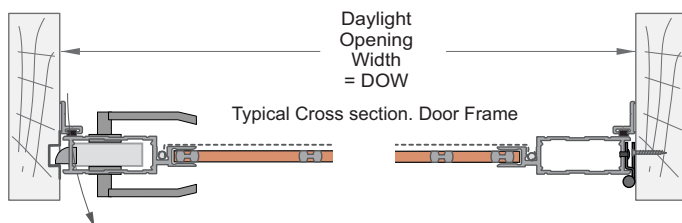
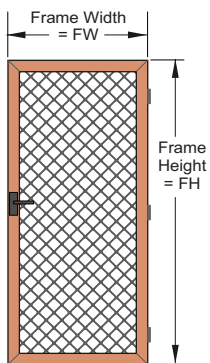
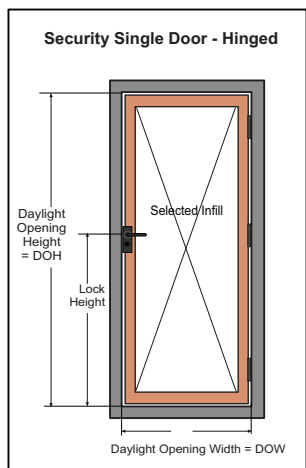
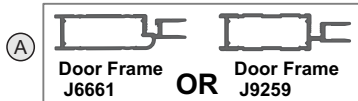

AMPLIMESH SINGLE HINGED DOOR Reveal Mount

	HEIGHTS, WIDTHS	Part	Cutting Calc	No
1	Door Frame Height FH	J6661 or J9259	(DOH - 6) = FH	2
2	Closing Angle Height	J3737	DOH	2
3	Woolpile Height	JC225	DOH	2
1	Door Frame Width FW	J6661 or J9259	(DOW - 6) = FW	2
2	Closing Angle Width	J3737	DOW - 15	1
3	Woolpile Width	JC225	DOW - 15	1

1	Amplimesh Panel Height	J103..	FH - 120	1
2a	If Insect Mesh, Height	JPS..	FH - 60	1
2b	If Insect Spline, Height	JC/220	FH - 60	2
3a	If Lookout, Panel Height	J301..	FH - 104	1
3b	If Lookout, Glazing Bead Height	JA9840	FH - 100	2
1	Amplimesh Panel Width	J103..	FW - 120	1
2a	If Insect Mesh, Width	JPS....	FW - 60	1
2b	If Insect Spline, Width	JC/220/300/..	FW - 60	2
3a	If Lookout Panel, Width	J301..	FW - 104	1
3b	If Lookout, Glazing Bead Width	JA9840/2.74/..	FW - 100	2
4	Door seal incl Mohair Width	JA186	FW	1

COMPONENTS - Always needed

	Description	Part No	No
1	75mm Strong Hinge	JC242	3
2	Corner Stake HD	JC216	4

+ Security Hinged Door Locks
(Identical for all Hinged Security Doors)
Choice of Austral Elegance, Austral Ultimate Whitco Tasman Mk2, Lockwood 8564 Associated Cylinders, Multipoint Kits and Black, White, SCC as appropriate
All as per Feb 2020 Price Book

Cutting calculations - These are a guide only, confirm before cutting
Strongly Recommended - Allow +30mm per cut to allow for Trimming/Mitre cuts and on site adjustment



JURALCO

www.juralco.co.nz ph (09) 478 8018

Juralco Amplimesh® Security Door and Window Systems

Issue 3-23 v1
Page 13

Juralco Amplimesh® Security Door and Window Systems - Hinged Door, Cutting, Assembly

Amplimesh Single Hinged Door + Adaptor

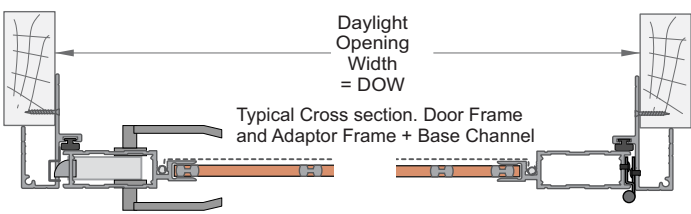
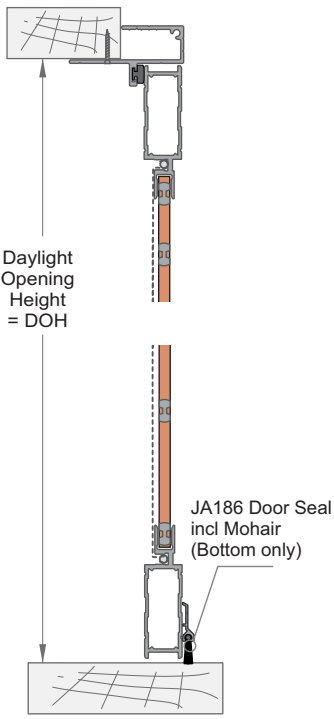
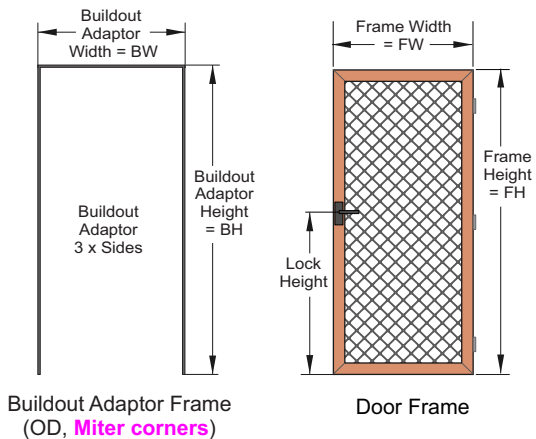
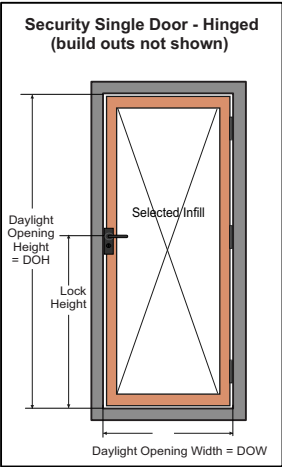

AMPLIMESH SINGLE HINGED DOOR + Adaptor J7467 x 3 sides

	HEIGHTS, WIDTHS	Part	Cutting Calc	No
1	Buildout Adaptor Height BH	J7467	$(DOH + 20) = BH$	2
2	Woolpile Height	JC225	$DOH + 20$	2
3	Door Frame Height FH	J6661 or J9259	$(DOH - 8) = FH$	2
1	Buildout Adaptor Width BW	J7467	$(DOW + 40) = BW$	1
2	Woolpile Width	JC225	$DOW + 40$	1
3	Door Frame Width FW	J6661 or J9259	$(DOW - 12) = FW$	2

1	Amplimesh Panel Height	J103....	$FH - 120$	1
2a	If Insect Mesh, Height	JPS....	$FH - 60$	1
2b	If Insect Spline, Height	JC/220	$FH - 60$	2
3a	If Lookout, Panel Height	J301...	$FH - 104$	1
3b	If Lookout, Glazing Bead Height	JA9840	$FH - 100$	2
1	Amplimesh Panel Width	J103..	$FW - 120$	1
2a	If Insect Mesh, Width	JPS....	$FW - 60$	1
2b	If Insect Spline, Width	JC/220/300/..	$FW - 60$	2
3a	If Lookout Panel, Width	J301...	$FW - 104$	1
3b	If Lookout, Glazing Bead Width	JA9840/2.74/..	$FW - 100$	2
4	Door seal incl Mohair Width	JA186	FW	1

COMPONENTS - Always needed

	Description	Part No	No
1	75mm Strong Hinge	JC242	3
2	Corner Stake HD	JC216	4

+ Security Hinged Door Locks (Identical for all Hinged Security Doors)
 Choice of Austral Elegance, Austral Ultimate Whitco Tasman Mk2, Lockwood 8564 Associated Cylinders, Multipoint Kits and Black, White, SCC as appropriate
 All as per Feb 2020 Price Book

Cutting calculations - These are a guide only, confirm before cutting
 Strongly Recommended - Allow +30mm per cut to allow for Trimming/Mitre cuts and on site adjustment

Juralco Amplimesh® Security Door and Window Systems - Hinged Door, Cutting, Assembly

Amplimesh Single Hinged Door + Build outs

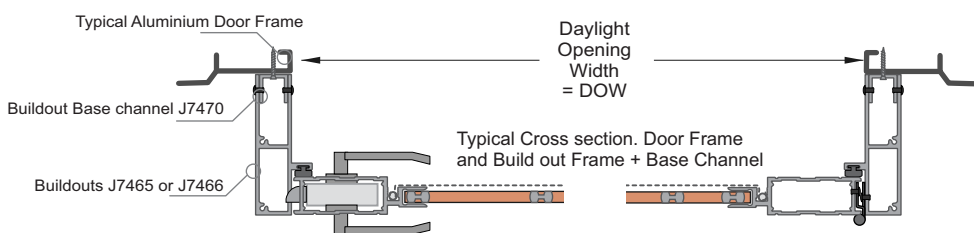
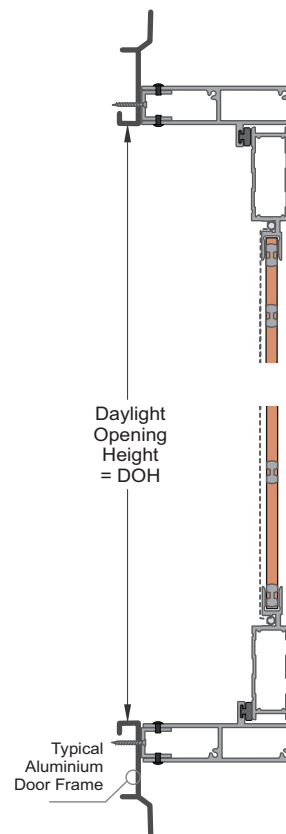
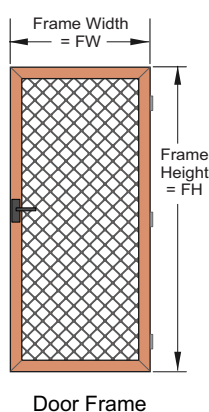
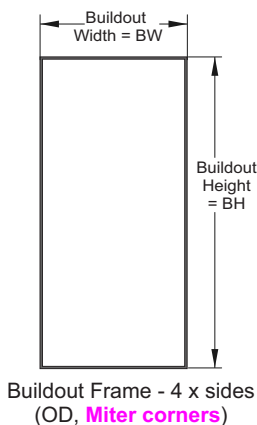
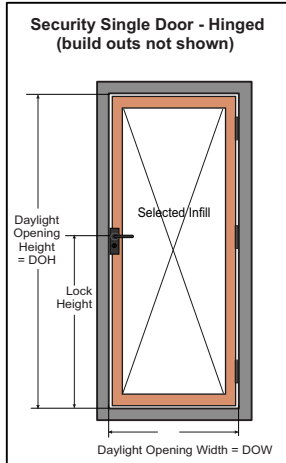
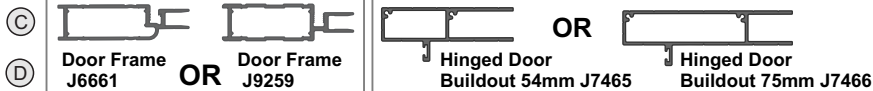

AMPLIMESH SINGLE HINGED DOOR + J7465 or J7466 Buildouts x 4 sides

Components, always needed

HEIGHTS, WIDTHS		Part	Cutting Calc	No
1	Buildout Height BH	J7465, J7466	(DOH + 40) = BH	2
2	Woolpile Height	JC225	DOH + 40	2
3	Buildout Base channel Height	J7470	DOH	2
4	Door Frame Height FH	J6661 or J9259	DOH - 6 (=FH)	2
1	Buildout Width BW	J7465, J7466	(DOW + 40) = BW	2
2	Woolpile Width	JC225	DOW + 40	2
3	Buildout Base channel Width	J7470	DOW	2
4	Door Frame Width FW	J6661 or J9259	(DOW - 6) = FW	2

Description	Part No	No
1 75mm Strong Hinge	JC242	3
2 Corner Stake HD	JC216	4

1	Amplimesh Panel Height	J103....	FH - 120	1
2a	If Insect Mesh, Height	JPS....	FH - 60	1
2b	If Insect Spline, Height	JC/220	FH - 60	2
3a	If Lookout, Panel Height	J301...	FH - 104	1
3b	If Lookout, Glazing Bead Height	JA9840	FH - 100	2
1	Amplimesh Panel Width	J103...	FW - 120	1
2a	If Insect Mesh, Width	JPS....	FW - 60	1
2b	If Insect Spline, Width	JC/220/300/..	FW - 60	2
3a	If Lookout Panel, Width	J301...	FW - 104	1
3b	If Lookout, Glazing Bead Width	JA9840/2.74/..	FW - 100	2

+ Security Hinged Door Locks

(Identical for all Hinged Security Doors)

Choice of Austral Elegance, Austral Ultimate Whitco Tasman Mk2, Lockwood 8564 Associated Cylinders, Multipoint Kits and Black, White, SCC as appropriate
All as per Feb 2020 Price Book

Cutting calculations - These are a guide only, confirm before cutting
Strongly Recommended - Allow +30mm per cut to allow for Trimming/Mitre cuts and on site adjustment



JURALCO

www.juralco.co.nz ph (09) 478 8018

Juralco Amplimesh® Security Door and Window Systems

Issue 3-23 v1
Page 15

Juralco Amplimesh® Security Door and Window Systems - Hinged Double Door, Cutting

Amplimesh Double Hinged Door Reveal Mount

(A)

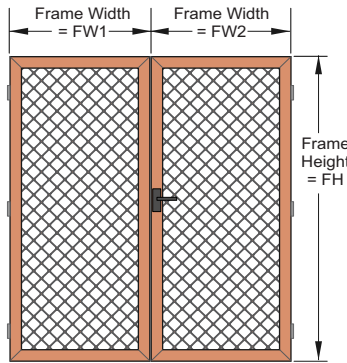
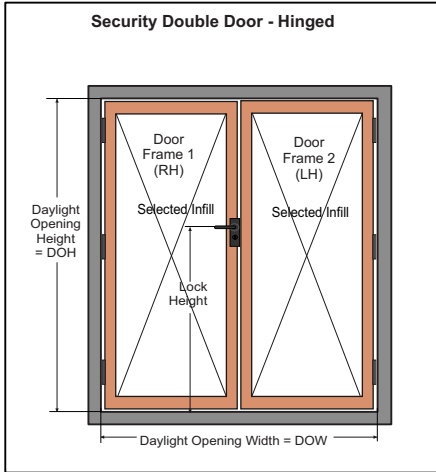

Door Frames
Door Widths can be Equal or Unequal

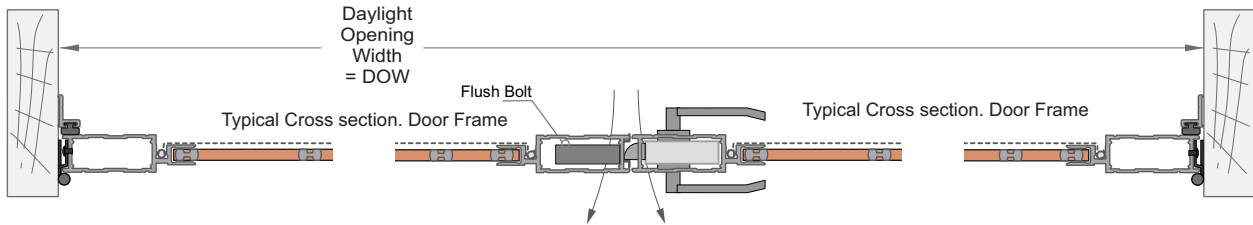
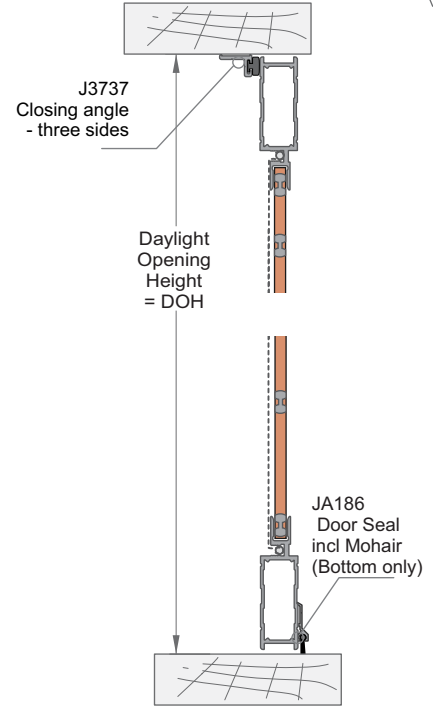

AMPLIMESH DOUBLE HINGED DOOR Reveal Mount

Door Widths can be Equal or Unequal

	HEIGHTS, WIDTHS	Part	Cutting Calc	No
1	Door Frame Height FH	J6661 or J9259	DOH - 6 (=FH)	4
2	Closing Angle Height	J3737	DOH	2
3	Woolpile Height	JC225	DOH	2
1	Door Frame Width EQUAL	J6661 or J9259	$(DOW-12)/2 = FW$	2
2	Door Frame Width Unequal FW1		Enter Width FW1	2
3	Door Frame Width Unequal FW2		$(DOW-FW1-12) = FW2$	2
4	Closing Angle Width	J3737	DOW-15	1
5	Woolpile Width	JC225	DOW-15	1

1	Amplimesh Panel Height	J103....	FH - 120	1
2a	If Insect Mesh, Height	JPS....	FH - 60	1
2b	If Insect Spline, Height	JC/220	FH - 60	2
3a	If Lookout, Panel Height	J301...	FH - 104	1
3b	If Lookout, Glazing Bead Height	JA9840	FH - 100	2
1	Amplimesh Panel Width	J103...	FW - 120	1
2a	If Insect Mesh, Width	JPS....	FW - 60	1
2b	If Insect Spline, Width	JC/220	FW - 60	2
3a	If Lookout Panel, Width	J301...	FW - 104	1
3b	If Lookout, Glazing Bead Width	JA9840	FW - 100	2

Cutting calculations - These are a guide only, confirm before cutting
Strongly Recommended - Allow +30mm per cut to allow for Trimming/Mitre cuts and on site adjustment

Components, always needed

	Description	Part No	No
1	75mm Strong Hinge	JC242	6
2	Heavy Duty Corner Stake	JC216	8
Select either Flushbolts			
3	Whitco Single Flushbolt	JJH203817	2
4	Austral Double Flushbolt, with Rods	JJMFlushbolt/BLK	1

+ Security Hinged Door Locks

(Identical for all Hinged Security Doors)
Choice of Austral Elegance, Austral Ultimate
Whitco Tasman Mk2, Lockwood 8564
Associated Cylinders, Multipoint Kits and
Black, White, SCC as appropriate
All as per Feb 2020 Price Book

Juralco Amplimesh® Security Door and Window Systems - Hinged Double Door, Cutting

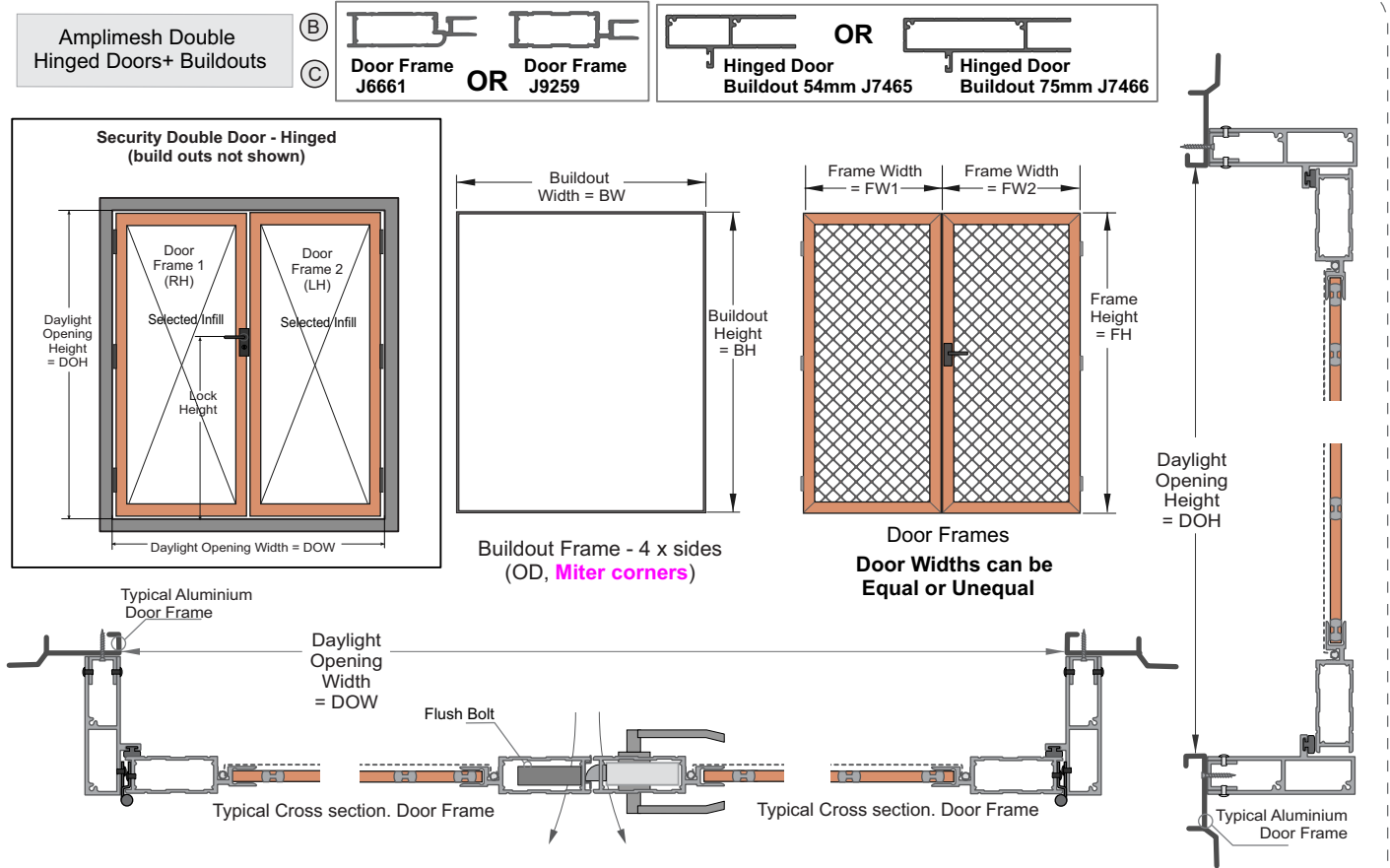

AMPLIMESH DOUBLE HINGED DOORS + Buildouts J7465 or J7466 x 4 sides

Door Widths can be Equal or Unequal

	HEIGHTS, WIDTHS	Part	Cutting Calc	No
1	Buildout Height BH	J7465 or J7466	$(DOH + 40) = BH$	2
2	Woolpile Height	JC225	$DOH + 40$	2
3	Buildout Base channel Height	J7470	DOH	2
4	Door Frame Height FH	J6661 or J9259	$(DOH - 6) = FH$	4
1	Buildout Width BW	J7465 or J7466	$(DOW + 40) = BW$	2
2	Woolpile Width	JC225	$DOW + 40$	2
3	Buildout Base channel Width	J7470	DOW	2
4	Door Frame Width EQUAL	J6661 or J9259	$(DOW - 12) / 2 = FW$	2
5	Door Frame Width Unequal FW1		Enter Width FW1	2
6	Door Frame Width Unequal FW2		$(DOW - FW1 - 12) = FW2$	2

1	Amplimesh Panel Height	J103....	$FH - 120$	1
2a	If Insect Mesh, Height	JPS....	$FH - 60$	1
2b	If Insect Spline, Height	JC/220	$FH - 60$	2
3a	If Lookout, Panel Height	J301...	$FH - 104$	1
3b	If Lookout, Glazing Bead Height	JA9840	$FH - 100$	2
1	Amplimesh Panel Width	J103...	$FW - 120$	1
2a	If Insect Mesh, Width	JPS....	$FW - 60$	1
2b	If Insect Spline, Width	JC/220	$FW - 60$	2
3a	If Lookout Panel, Width	J301...	$FW - 104$	1
3b	If Lookout, Glazing Bead Width	JA9840	$FW - 100$	2

Cutting calculations - These are a guide only, confirm before cutting
Strongly Recommended - Allow +30mm per cut to allow for Trimming/Mitre cuts and on site adjustment

Components, always needed

	Description	Part No	No
1	75mm Strong Hinge	JC242	6
2	Heavy Duty Corner Stake	JC216	8
Select either Flushbolts			
3	Whitco Single Flushbolt	JJH203817	2
4	Austral Double Flushbolt, with Rods	JJMFlushbolt/BLK	1

+ Security Hinged Door Locks

(Identical for all Hinged Security Doors)

Choice of Austral Elegance, Austral Ultimate
Whitco Tasman Mk2, Lockwood 8564
Associated Cylinders, Multipoint Kits and
Black, White, SCC as appropriate
All as per Feb 2020 Price Book

Juralco Amplimesh® Security Door and Window Systems - Hinged Door, Machining

Security Hinged Door Machining

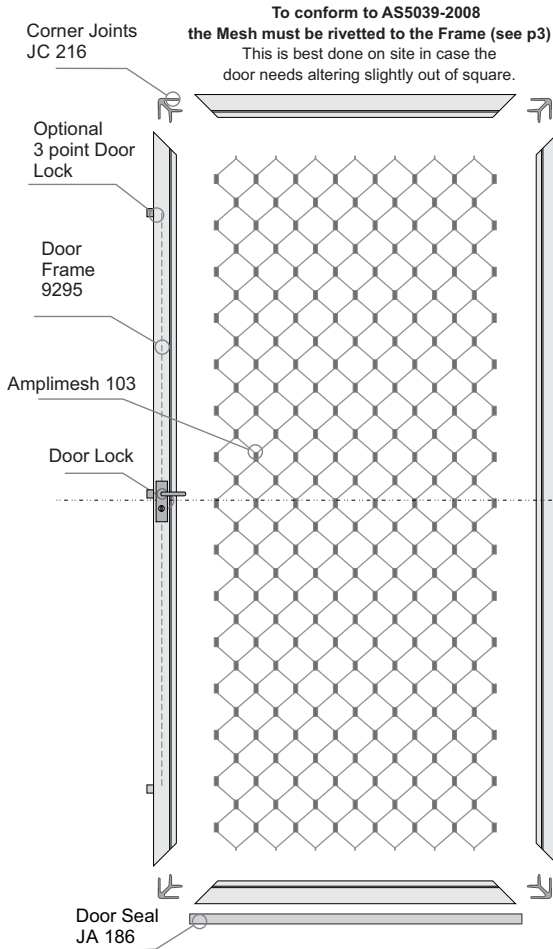

Hinged Security Doors - Lock Selection
Centre only or Three point Lock, Cable Drive.
Mortice or Parrot Beak

Elegance Door Frame Machining

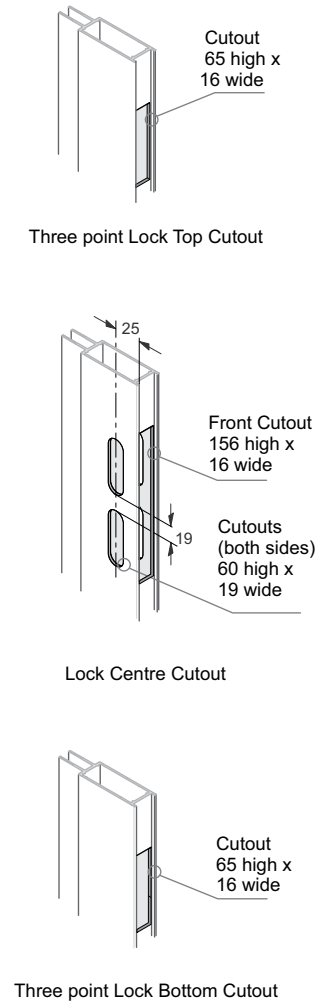

Ultimate Door Frame Machining

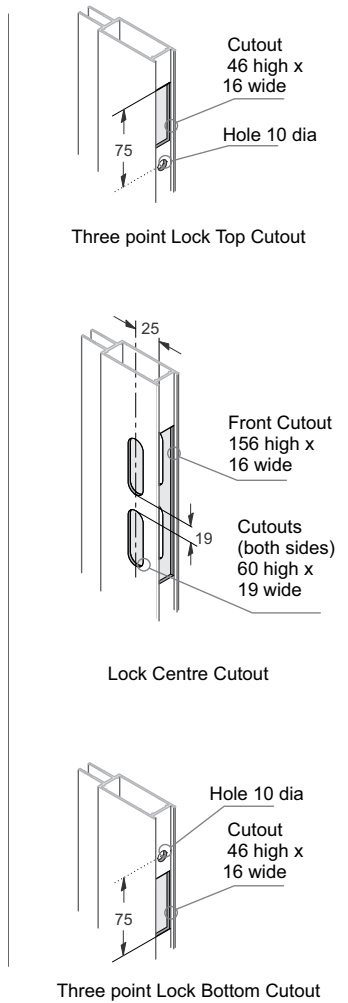

Elegance, Ultimate Door Frame Machining Setouts

Elegance, HD14	A dim	B dim
Machining setouts	to Top	to Bottom
High centre Lock	682	826
Low Centre Lock	826	682
Pool Centre Lock	375	961
Set out tolerances all +/- 3mm		

Ultimate, HD16	C dim	D dim
Machining setouts	to Top	to Bottom
High centre Lock	610	790
Low Centre Lock	766	634
Pool Centre Lock	313	1079
Set out tolerances all +/- 3mm		

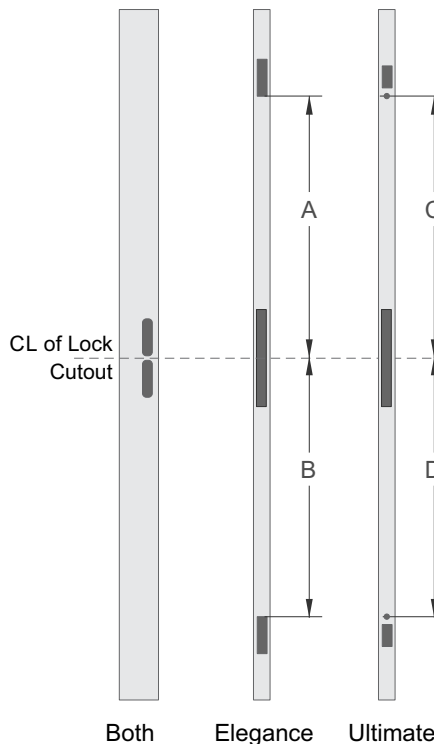

Elegance, Ultimate Cylinders, Striker Plates

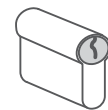

Double Cylinders
Ordered Separately

Elegance, AA-C4
5 pin double cylinder

Ultimate, AA8-C4
5 pin double cylinder
Ultimate Cylinders must include a cam stop spring

A range of different Striker Plates is available.
- 7 for the Elegance,
- 6 for the Ultimate.
Refer manufacturers catalog

Security Hinged Door - Assembly

- 1 - Use the table above to calculate the size for the Amplimesh Security Door.
- 2 - Cut door frame out of section 9295 and if using prepunched frame (for locks) make sure when cutting that the lock position is allowed for in your cutting (height wise) and the lock hole is in the correct position for either right or left hand opening.
If 3 point lock selected mill out to specifications.
- 3 - There are two alternative methods for trimming and fitting Amplimesh grille to frame:
Take Amplimesh grille and trim down to size by using hacksaw, bolt cutters, jigsaw, bandsaw or table saw, provided they have a metal cutting blade. Assemble the frame around the grille by fitting the two stiles and then the top and bottom rail which contain the corner stakes. Assemble one stile and one rail and fit grille into half the frame. Mark down the grille the excess material and cut through grille using bolt cutters. Fit the other stile and rail to grille, square frame onto grille and rivet through edge of frame into corner stakes.
To conform to AS5039-2008 the Mesh must be rivetted to the Frame (see p3). This best completed on site as the door may need altering slightly out of square.
Place insect screen mesh over frame. By using a small piece of spline, tack mesh to frame top and bottom to hold mesh from moving. Pre groove the mesh into the spline groove with roller, then, taking the spline, force this into spline groove over the mesh. Trim off excess mesh when finished with sharp knife.
- 4 - Fit hinges to frame. One in centre and one at each end of stile approx 200mm in from each end.
Use rebated hinges designed to fit over nib of door frame.
- 5 - Fit lock into stile which has been milled out previously.
- 6 - Cut and prepare closing angle for door now ready for installation.

Security Hinged Door - Installation

- 1 - Check door fits into reveal and the door has been made to site measurements.
- 2 - Lift the door with 3mm packer on step to give clearance at the bottom.
- 3 - Screw the top & bottom hinge to the reveal with 1 screw in the middle hole of the hinge.
- 4 - Check the door swings correctly and fits into the reveal.
 - a - If the door catches on the handle/lock side, check the hinges into the reveal.
 - b - If the door needs to be lifted or dropped on the diagonal, the door frame will need to be pinned to the grille in two places on each side. The rivets should be fitted on the inside of the door. Either drill through the mesh, or remove spline and mesh from each corner, drill & fit the rivets, then replace the mesh and spline.
- 5 - Screw the striker plate to the reveal in line with the door lock.
- 6 - Use a 3mm twist drill to drill out the rebate for the lock.
Chisel the remainder of the timber out of the lock rebate.
- 7 - Screw the closing angle onto the reveal when the door is closed.
If the closing angle catches the door handle, the closing angle will need to be cut away to clear the handle.
- 8 - Paint the exposed edge with the appropriate colour.
- 9 - Always clean off all fingermarks, leave the site clean and tidy.

Security Hinged Door - Build out Installation

- 1 - The Adaptor box is manufactured and installed first; the security door is then hung from it.
- 2 - Check the door is the correct size for the application.
- 3 - Measure the internal width of the build out frame to determine the size and setout for the base channel brackets (BCB).
- 4 - The BCB (8 per door) are screwed to the existing door frame. 1 x each Top and Bottom, 3 x each side in line with the hinges / locking points. Fixing may be from the outside or inside depending on the existing aluminium joinery door frame.
Note: In some situations, the house door may have to be removed from the hinges (knock out hinge pins)
- 5 - Slide the build out frame over the 8 x BCB and position it so that the existing door opens and closes easily.
- 6 - The door must fit evenly within the build out frame, ie. the door should have the same gaps top and bottom, and an even gap on the handle side. Open the door and, working from the inside, use 6g x 12mm pan s/s screws to fix the build out frame to each of the 8 x BCB. Alternatively, pop rivets can be used.
- 7 - Check the door operates correctly, including the handle and lock.
- 8 - Always clean off all fingermarks, leave the site clean and tidy.

Amplimesh® Single Door Hinged		SD#
Customer		
Order No	Date	
WO Juralco		SO Juralco
		\$ Juralco
Select/Enter Dimensions below. Enter details/selections into all boxes. Then scan and send to sales@juralco.co.nz		

This Order Form - Amplimesh® Single Door, Hinged only.

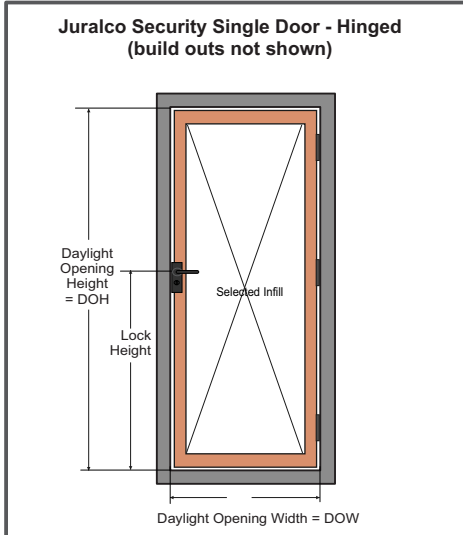

1 Enter Location

Enter Sizes	Dimensions mm	Daylight OH	Daylight OW	Max DOH, DOW - Height 2450mm - Width 1275mm

2 Duralloy Duralloy Plus Duratec OR Select Anodising

Select Finish **Specify PC Colour and Code**

Natural
Bronze

3 Select Buildouts, Options

A	None	<input type="checkbox"/>	Select options								
	B		J7465 Buildout 4 x Sides	<input type="checkbox"/>	Insect Screens (Black)	No	Fibreglass Mesh	Midge Mesh	Petscreen Mesh	Lookout Mesh	
C		J7466 Buildout 4 x Sides	<input type="checkbox"/>	Door Frames	J9295 Square	J6661 Curved	JD100 Snib Protector	No	Poly	White	SCC
D		J7467 Adaptor Sides and Top	<input type="checkbox"/>	Door Lock Punching	No	Yes	Height	LH or RH Closing			
				Hinge JC242 Finish	SS	White	Black	SCC			
				Heavy Duty Door Closer	No	White	Black				

4 Elegance Lock Options

Lock Finish	White	Black	SCC	Multi Point Kits	High	Low	Pool	Wide Strike Plate	No	Yes
	C4 Cylinders	46mm Wafer Random	5 pin Random 64mm Key		5 pin Keyed alike	6 pin Keyed alike	LH Thumb Turn, Random		RH Thumb Turn, Random	

5 Ultimate Lock Options

Lock Finish	Black	SCC	Multi Point Kits	High	Low

6 Whitco Tasman Mk2 Lock Options

Lock Finish	White	Black	Lock Cylinders	Random Key	Keyed Alike	Extra Wide Strike Plate	No	Yes	Anti Jemmy Kit	No	Yes

7 Lockwood 8654 Lock Options

Lock Finish	White	Black	Lock Cylinders	Random Key	Keyed Alike	Extra Wide Strike Plate	No	Yes	Standard 3 Point Kit	No	Yes

8 Remarks

Amplimesh® Double Door Hinged		SD#
Customer		
Order No	Date	
WO Juralco	SO Juralco	\$ Juralco
Select/Enter Dimensions below. Enter details/selections into all boxes. Then scan and send to sales@juralco.co.nz		

This Order Form - Amplimesh® Double Door, Hinged only.

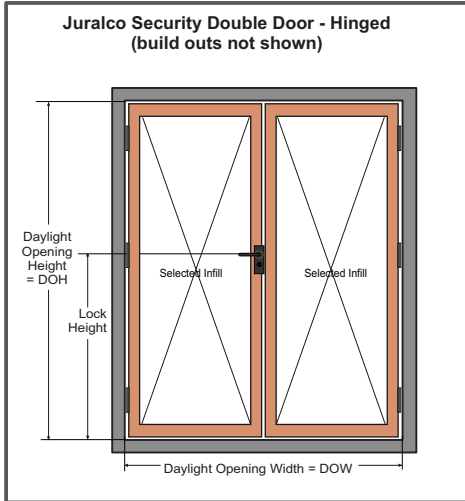

1 Enter Location

Enter Sizes	Dimensions mm	Daylight OH	Daylight OW	Max DOH, DOW - Height 2450mm - Width 2530mm

2 Duralloy Duralloy Plus Duratec OR Select Anodising

Select Finish

Specify PC Colour and Code

Natural

Bronze

3 Select Buildouts, Options

A	None	<input type="checkbox"/>	Select options						
			Insect Screens (Black)	No	Fibreglass Mesh	Midge Mesh	Petscreen Mesh	Lookout Mesh	
B		J7465 Buildout 4 x Sides	<input type="checkbox"/>	Door Frames		J9295 Square	J6661 Curved		
					JD100 Snib Protector		No	Poly	White
C		J7466 Buildout 4 x Sides	<input type="checkbox"/>	Door Lock Punching		No	Yes	Height	LH or RH Frame
					Hinge JC242 Finish		SS	White	Black

Select more options

Whitco Flush Bolts	Singles x 2	Double		
		Heavy Duty Door Closer		
		No	White	Black

4 Elegance Lock Options

Lock Finish	White	Black	SCC	Multi Point Kits	High	Low	Pool	Strike Plate	NA	Narrow	Wide
C4 Cylinders	46mm Wafer Random	5 pin Random 64mm Key	5 pin Keyed alike	6 pin Keyed alike	LH Thumb Turn, Random	RH Thumb Turn, Random					

5 Ultimate Lock Options

Lock Finish	Black	SCC	Multi Point Kits	High	Low

6 Whitco Tasman Mk2 Lock Options

Lock Finish	White	Black	Lock Cylinders	Random Key	Keyed Alike	Extra Wide Strike Plate	No	Yes	Anti Jemmy Kit	No	Yes

7 Lockwood 8654 Lock Options

Lock Finish	White	Black	Lock Cylinders	Random Key	Keyed Alike	Extra Wide Strike Plate	No	Yes	Standard 3 Point Kit	No	Yes

8 Remarks

Juralco Amplimesh® Security Door and Window Systems - Sliding Door Extrusions

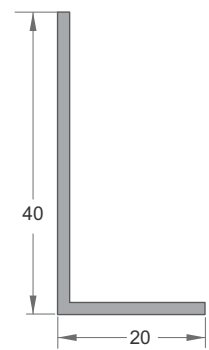
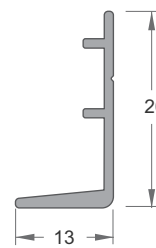
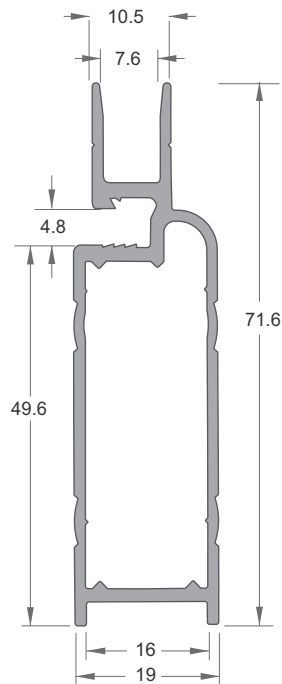
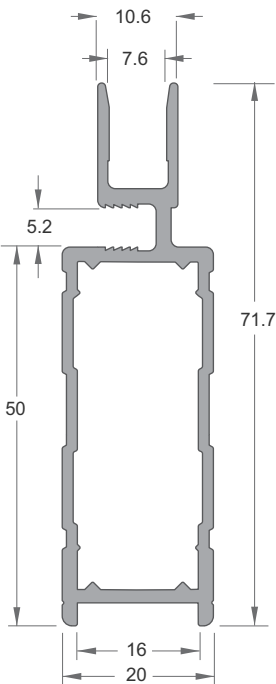
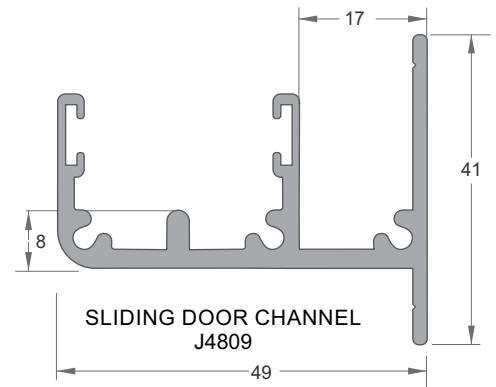
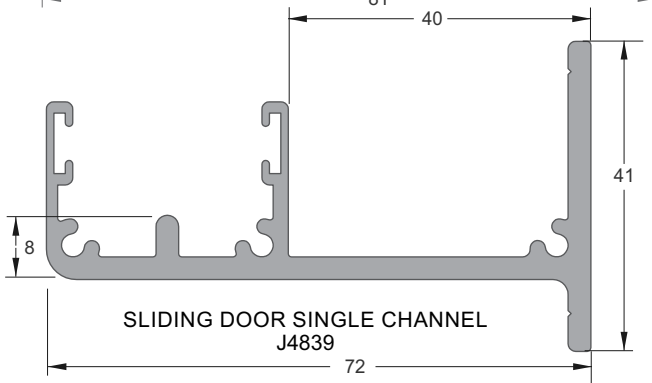
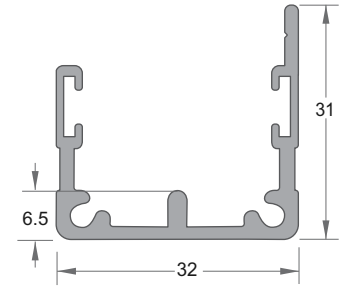
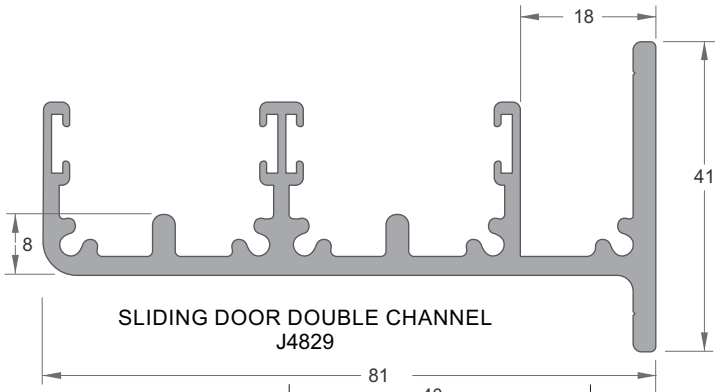
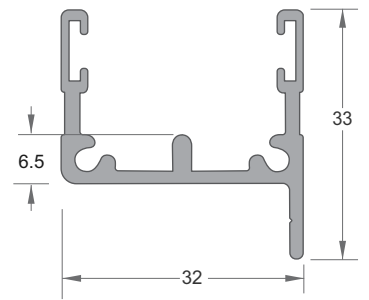
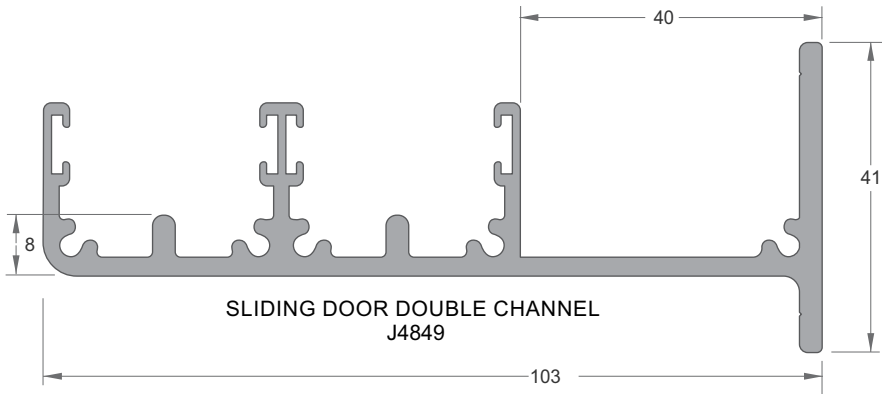

Juralco Amplimesh® Security Door and Window Systems - Sliding Door Components

Sliding Door Locks SD7Plus + SD14Plus Kit

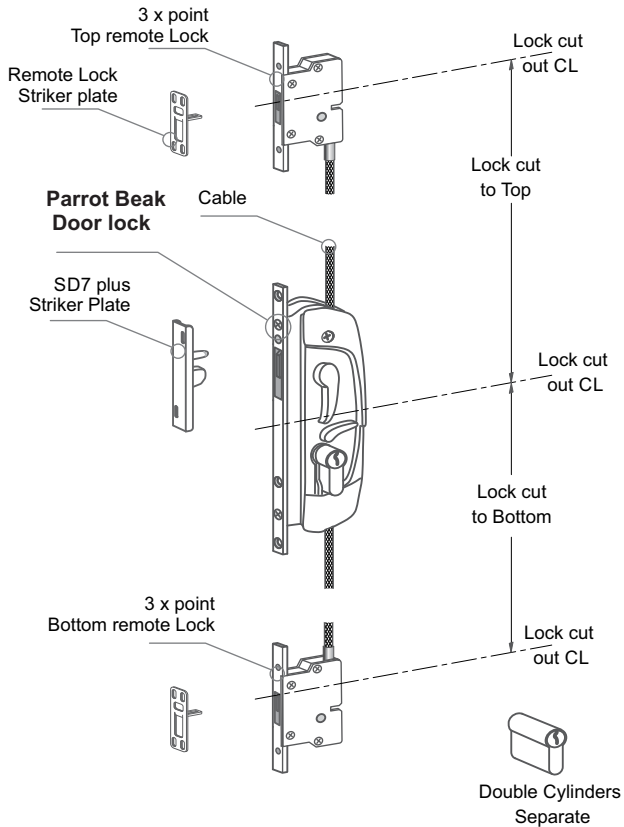

Sliding Security Doors - Lock Selection

- a - This lock can be used for RH or LH sliding doors .
- b - Standard, Three_point Lock - including Parrot Beak Door Lock, Cable Drive, Top and Bottom Remote Parrot beak locks
- c - Available in four different CL combinations

Refer Austral Catalog for more information

Nylon End Stop JC203



Door Stop JP2306



Staking Angle, Heavy Duty JC216

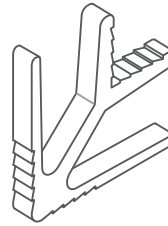

Kwikfit Roller JC206

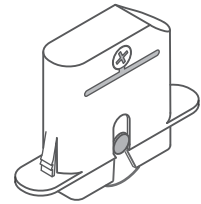

Patio Bolt JJH22063



Mohair Strip JC225

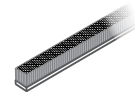

350mt Roll

Patio Bolt JJM316B

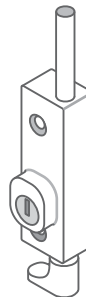

Black only

Patio Bolt JM283



Security Door Sliding Track End Caps

All attach with, screws
2 x JVBSCREW/10x6

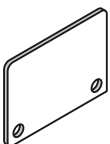

JC458
For J4558, J4559 Tracks

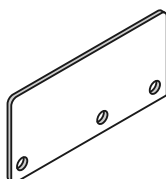

JC809
For J4809 Track

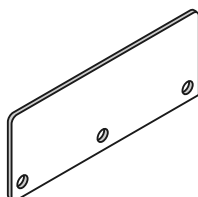

JC839
For J4839 Track

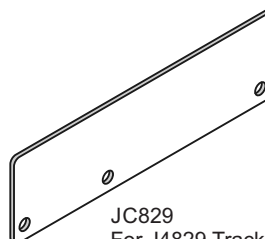

JC829
For J4829 Track

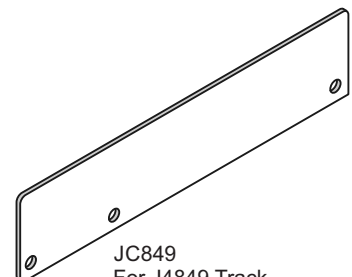

JC849
For J4849 Track

Juralco Amplimesh® Security Door and Window Systems - Sliding Door, General

Security Sliding Door Recommendations

- 1 - **Frame** - Heavy duty Door Frame PN 9295
- 2 - **Corner Joints** - JC 216 attach all corners .
After assembling the frame the door should stay completely rigid.
- 3 - **Security Grille** - Amplimesh Security Grille 103
- 4 - **Locks** - We recommend Austral Murray SD7, SD8 or Whitco Leichardt
Kits can be added to convert to 3 point locks.
- 5 - **Inter locker** - The two piece interlock system securely locks the back edge of the sliding security door to the existing mullion.
Select 9716, 9717 or 9718 Male Interlock sections as appropriate for the door/mullion gap.
- 6 - **Fasteners** - High strength, stainless steel rivets to be used for fastening corner stakes, hinges and grille to frame.
Size and application of rivets must allow no movement between parts. Stainless 8-gauge fixing screws can be used as an alternative.
The heads of all fasteners must be concealed to restrict access from outside when the door is closed.

For face mounting, on the exterior only.
Insect screen options.

Note - This configuration can be used to add security to any Door opening. The frame and security grille are lightweight and suitable for all environments.

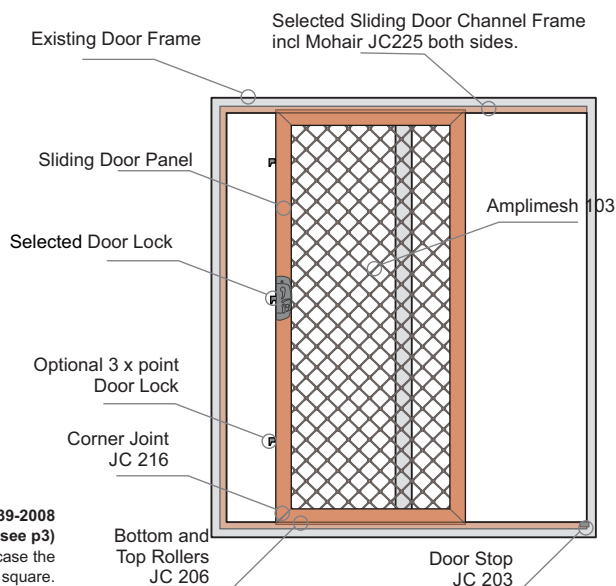

To conform to AS5039-2008
the Mesh must be rivetted to the Frame (see p3)
This is best done on site in case the door needs altering slightly out of square.

Security Sliding Door Measuring

Check list for measuring up a Security Door

- 1 - **Select Sliding Door Channel Frame (SDCF)**
Choose 4559 32mm Channel for a normal Door, or 4809 49mm Channel if an offset is needed or opening a sash window on existing slider.
- 2 - **Fixing Method** - Determine method of fixing SDCF to face of existing joinery. Is there sufficient fixing or is a box section or angle pocket required.
- 3 - **Frame** - Will SDCF be 4 sides or 3 sides only (ie nonlocking vertical side left open)
- 4 - **SDC Setout** - Determine actual fixing position of SDCF by using extrusion offcut, locate, mark and measure for overall height and width of SDCF.
- 5 - **Sliding Door Panel (SDP) Height Setout**
When installing the door, use the height adjustment to locate the SDP to the SDCF.
- 6 - **Sliding Door Panel (SDP) Width Setout**
To determine width of SDP.
Care must be taken when measuring to determine:
 - (i) Which Interlock to use on existing aluminium joinery mullion, either 9716 or 9717.
 - (ii) Ensure that the Interlock chosen locates securely into the 9719 Female Interlock when the SDP is in the locked position.
This is the critical factor in determining the actual width of the SDP
 - (iii) Determine points (i) & (ii) & using offcut extrusion mark & measure width accordingly.
- 7 - **Check** around doorway to see there are no protruding fuse boxes or hanging lights to stop security door from fully opening.
- 8 - **Check** to see that there are no door knockers or door bells that may require relocating before security door could be installed.
- 9 - **Check** colour finish of security door and type of Amplimesh panel required

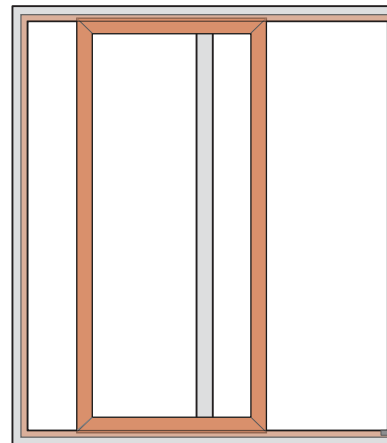

Juralco Amplimesh® Security Door and Window Systems - Sliding Door, Cutting

Clearguard Single Sliding Door

(A)

J4558 Track Closing

J4559 Track Top and Bottom

Door Frame J9259 OR Door Frame J6661

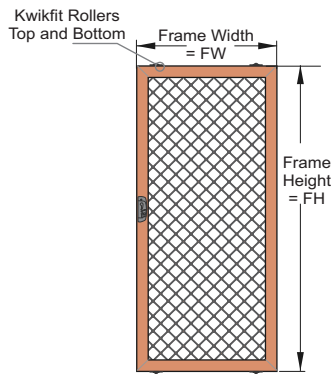
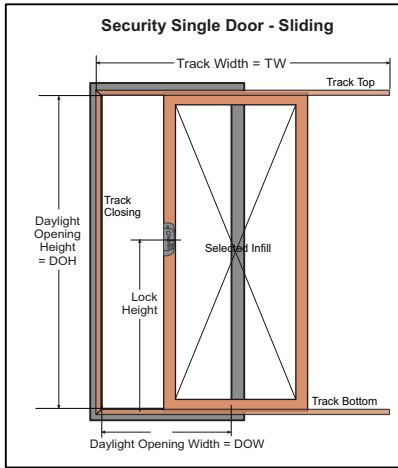

Door Frame

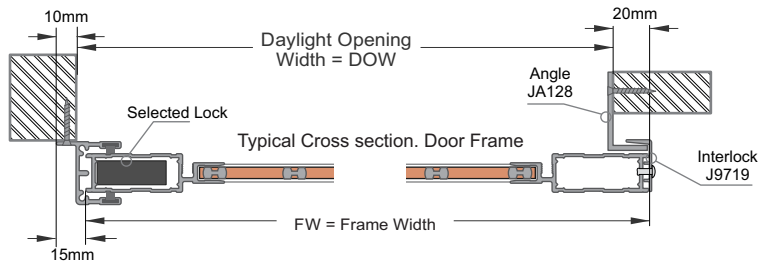
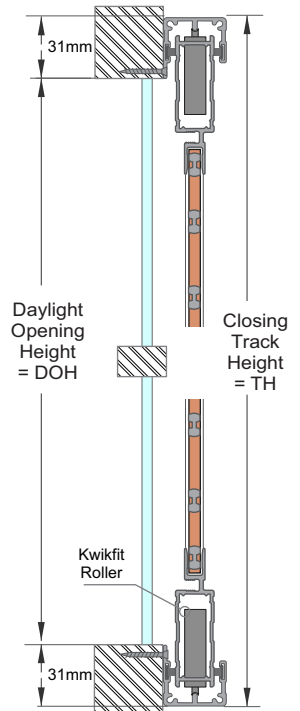

AMPLIMESH SINGLE SLIDING DOOR Tracks J4558/J4559

Components, always needed

	HEIGHTS, WIDTHS	Part	Cutting Calc	No
1	Closing Track Height TH	J4558	$(DOH + 64) = TH$	1
2	Woolpile Height	JC225	TH	2
3	Door Frame Height FH	J6661 or J9259	$(DOH + 42) = FH$	2
1	Track Width TW	J4559	Enter Width = TW	2
2	Woolpile Width	JC225	TW	4
3	Door Frame Width FW	J6661 or J9259	$(DOW + 5) = FW$	2

	Description	Part No	No
1	Kwikfit Roller	JC206	4
2	Corner Stake HD	JC216	4
3	Track End Cap	JC458	2
4	Track End Stop	JC203	1

1	Amplimesh Panel Height	J103....	FH - 120	1
2	Door Interlock Extrusion	J9719	FH	1
3	Wall Interlock Angle	JA128	FH	1
4a	If Insect Mesh, Height	JPS....	FH - 60	1
4b	If Insect Spline, Height	JC/220	FH - 60	2
5a	If Lookout, Panel Height	J301...	FH - 104	1
5b	If Lookout, Glazing Bead Height	JA9840	FH - 100	2
1	Amplimesh Panel Width	J103...	FW - 120	1
2a	If Insect Mesh, Width	JPS....	FW - 60	1
2b	If Insect Spline, Width	JC/220	FW - 60	2
3a	If Lookout Panel, Width	J301...	FW - 104	1
3b	If Lookout, Glazing Bead Width	JA9840	FW - 100	2

+ Security Sliding Door Locks

Choice of Austral Murray SD7, SD8 or Whitco Liechardt.

Associated Cylinders, Multipoint Kits and Black, White, SCC finishes for SD7, SD8 All as per Feb 2020 Price Book

Cutting calculations - These are a guide only, confirm before cutting
Strongly Recommended - Allow +30mm per cut to allow for Trimming/Mitre cuts and on site adjustment



JURALCO

www.juralco.co.nz ph (09) 478 8018

Juralco Amplimesh® Security Door and Window Systems

Issue 3-23 v1
Page 25

Juralco Amplimesh® Security Door and Window Systems - Sliding Door, Cutting

Amplimesh Single Sliding Door

(B)

J4558 Track Top and Closing

J4559 Track Bottom

Door Frame J9259 OR Door Frame J6661

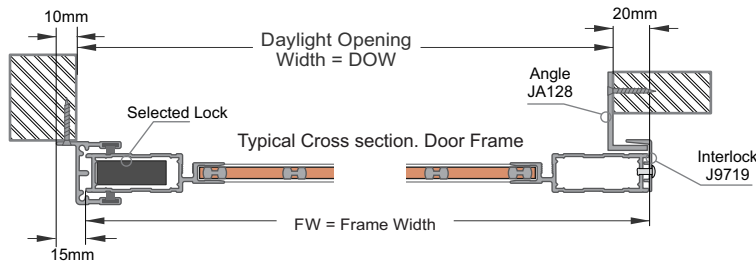
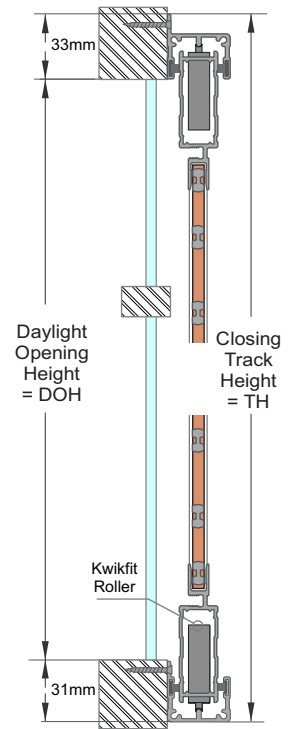
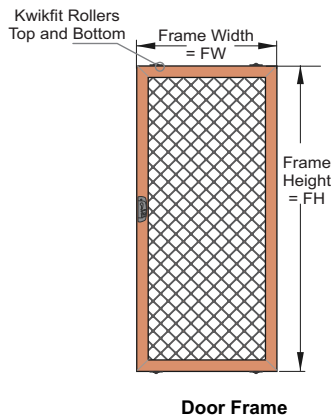
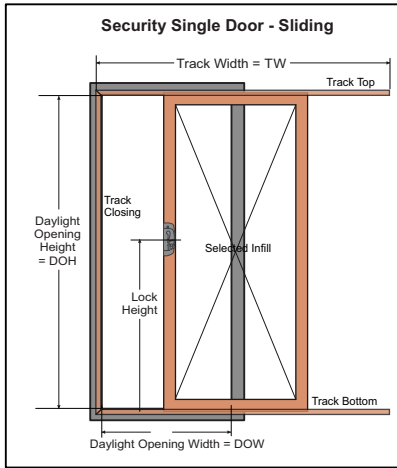

AMPLIMESH SINGLE SLIDING DOOR Tracks J4558/J4559

Components, always needed

	HEIGHTS, WIDTHS	Part	Cutting Calc	No
1	Closing Track Height TH	J4558	$(DOH + 64) = TH$	1
2	Woolpile Height	JC225	TH	2
3	Door Frame Height FH	J6661 or J9259	$(DOH + 35) = FH$	2
1	Track Width	J4558, J4559	Enter Width = TW	1ea
2	Woolpile Width	JC225	TW	4
3	Door Frame Width FW	J6661 or J9259	$(DOW + 5) = FW$	2

	Description	Part No	No
1	Kwikfit Roller	JC206	4
2	Corner Stake HD	JC216	4
3	Track End Cap	JC458	2
4	Track End Stop	JC203	1

1	Amplimesh Panel Height	J103....	FH - 120	1
2	Door Interlock Extrusion	J9719	FH	1
3	Wall Interlock Angle	JA128	FH	1
4a	If Insect Mesh, Height	JPS....	FH - 60	1
4b	If Insect Spline, Height	JC/220	FH - 60	2
5a	If Lookout, Panel Height	J301...	FH - 104	1
5b	If Lookout, Glazing Bead Height	JA9840	FH - 100	2
1	Amplimesh Panel Width	J103...	FW - 120	1
2a	If Insect Mesh, Width	JPS....	FW - 60	1
2b	If Insect Spline, Width	JC/220	FW - 60	2
3a	If Lookout Panel, Width	J301...	FW - 104	1
3b	If Lookout, Glazing Bead Width	JA9840	FW - 100	2

+ Security Sliding Door Locks

Choice of Austral Murray SD7, SD8 or Whitco Liechardt.

Associated Cylinders, Multipoint Kits and Black, White, SCC finishes for SD7, SD8 All as per Feb 2020 Price Book

Cutting calculations - These are a guide only, confirm before cutting
Strongly Recommended - Allow +30mm per cut to allow for Trimming/Mitre cuts and on site adjustment

Juralco Amplimesh® Security Door and Window Systems - Sliding Door, Cutting

Amplimesh Single Sliding Door



J4558 Track Bottom and Closing

J4559 Track Top

OR
Door Frame J9259 Door Frame J6661

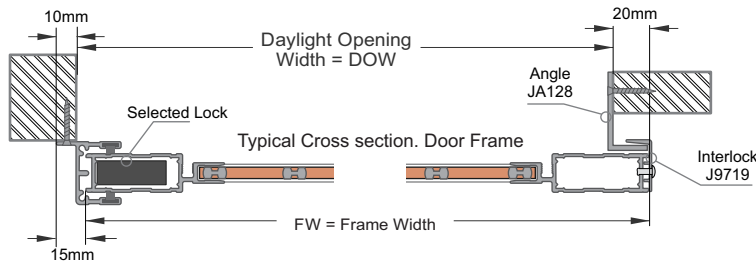
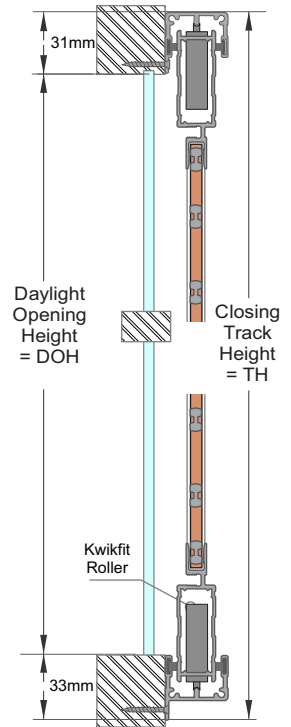
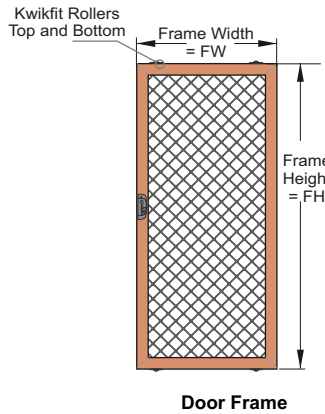
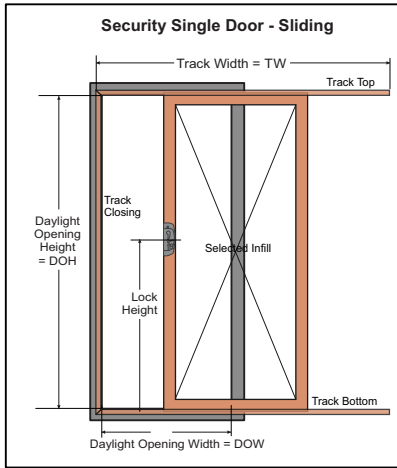

AMPLIMESH SINGLE SLIDING DOOR Tracks J4558/J4559

Components, always needed

	HEIGHTS, WIDTHS	Part	Cutting Calc	No
1	Closing Track Height TH	J4558	$(DOH + 64) = TH$	1
2	Woolpile Height	JC225	TH	2
3	Door Frame Height FH	J6661 or J9259	$(DOH + 35) = FH$	2
1	Track Width TW	J4558, J4559	Enter Width = TW	1ea
2	Woolpile Width	JC225	TW	4
3	Door Frame Width FW	J6661 or J9259	$(DOW + 5) = FW$	2

	Description	Part No	No
1	Kwikfit Roller	JC206	4
2	Corner Stake HD	JC216	4
3	Track End Cap	JC458	2
4	Track End Stop	JC203	1

1	Amplimesh Panel Height	J103....	FH - 120	1
2	Door Interlock Extrusion	J9719	FH	1
3	Wall Interlock Angle	JA128	FH	1
4a	If Insect Mesh, Height	JPS....	FH - 60	1
4b	If Insect Spline, Height	JC/220	FH - 60	2
5a	If Lookout, Panel Height	J301...	FH - 104	1
5b	If Lookout, Glazing Bead Height	JA9840	FH - 100	2
1	Amplimesh Panel Width	J103...	FW - 120	1
2a	If Insect Mesh, Width	JPS....	FW - 60	1
2b	If Insect Spline, Width	JC/220	FW - 60	2
3a	If Lookout Panel, Width	J301...	FW - 104	1
3b	If Lookout, Glazing Bead Width	JA9840	FW - 100	2

+ Security Sliding Door Locks

Choice of Austral Murray SD7, SD8 or Whitco Liechardt.

Associated Cylinders, Multipoint Kits and Black, White, SCC finishes for SD7, SD8
All as per Feb 2020 Price Book

Cutting calculations - These are a guide only, confirm before cutting
Strongly Recommended - Allow +30mm per cut to allow for Trimming/Mitre cuts and on site adjustment

Juralco Amplimesh® Security Door and Window Systems - Sliding Door, Cutting

Amplimesh Single Sliding Door

(D)
(E)

J4809 Track Top, Bottom and Closing OR J4839 Track Top, Bottom and Closing

Door Frame J9259 OR Door Frame J6661

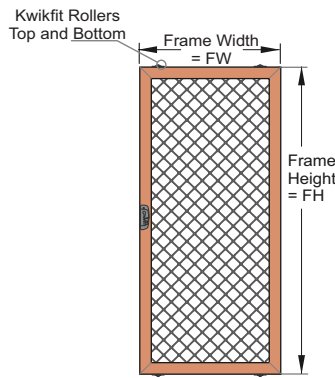
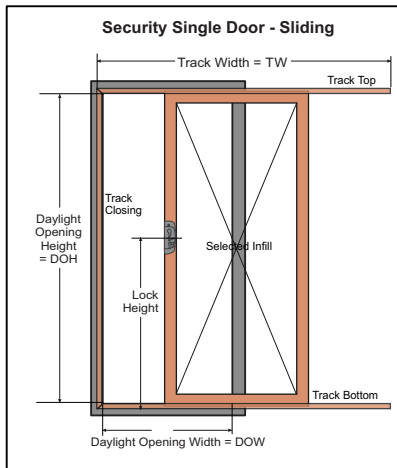

Door Frame

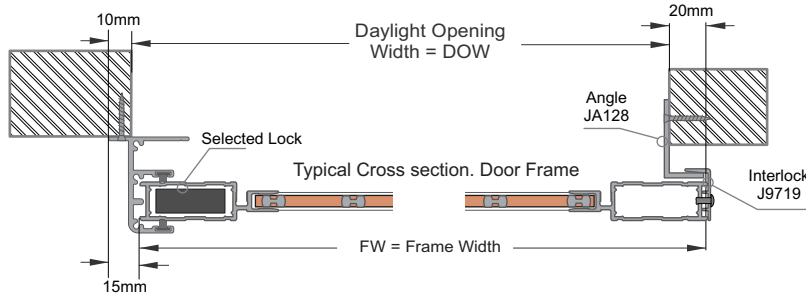
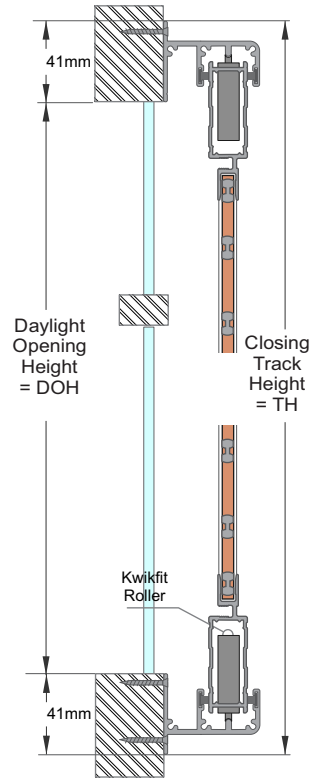

AMPLIMESH SINGLE SLIDING DOOR Tracks J4809 or J4839

Components, always needed

	HEIGHTS, WIDTHS	Part	Cutting Calc	No
1	Closing Track Height TH	J4809 or J4839	$(DOH + 82) = TH$	1
2	Woolpile Height	JC225	TH	2
3	Door Frame Height FH	J6661 or J9259	$(DOH + 41) = FH$	2
1	Track Width TW	J4809 or J4839	Enter Width = TW	2
2	Woolpile Width	JC225	TW	4
3	Door Frame Width FW	J6661 or J9259	$(DOW + 5) = FW$	2

	Description	Part No	No
1	Kwikfit Roller	JC206	4
2	Corner Stake HD	JC216	4
3	Track End Cap	JC458	2
4	Track End Stop	JC203	1

1	Amplimesh Panel Height	J103...	FH - 120	1
2	Door Interlock Extrusion	J9719	FH	1
3	Wall Interlock Angle	JA128	FH	1
4a	If Insect Mesh, Height	JPS...	FH - 60	1
4b	If Insect Spline, Height	JC/220	FH - 60	2
5a	If Lookout, Panel Height	J301...	FH - 104	1
5b	If Lookout, Glazing Bead Height	JA9840	FH - 100	2
1	Amplimesh Panel Width	J103...	FW - 120	1
2a	If Insect Mesh, Width	JPS...	FW - 60	1
2b	If Insect Spline, Width	JC/220	FW - 60	2
3a	If Lookout Panel, Width	J301...	FW - 104	1
3b	If Lookout, Glazing Bead Width	JA9840	FW - 100	2

+ Security Sliding Door Locks

Choice of Austral Murray SD7, SD8 or Whitco Liechardt.

Associated Cylinders, Multipoint Kits and Black, White, SCC finishes for SD7, SD8 All as per Feb 2020 Price Book

Cutting calculations - These are a guide only, confirm before cutting
Strongly Recommended - Allow +30mm per cut to allow for Trimming/Mitre cuts and on site adjustment

Juralco Amplimesh® Security Door and Window Systems - Sliding Door, Cutting

Amplimesh Double Stacking Sliding Door

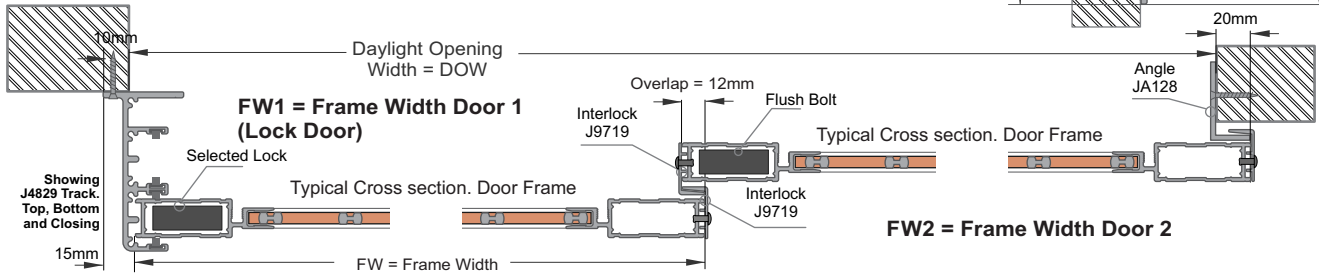
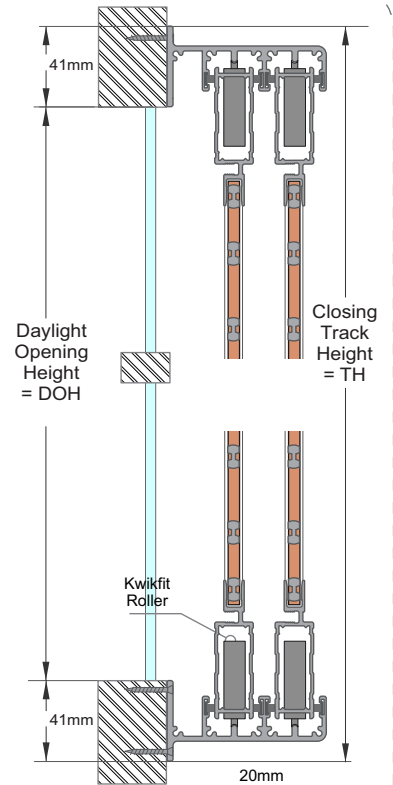
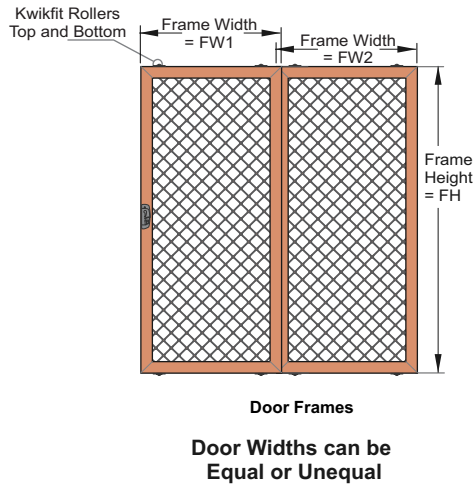
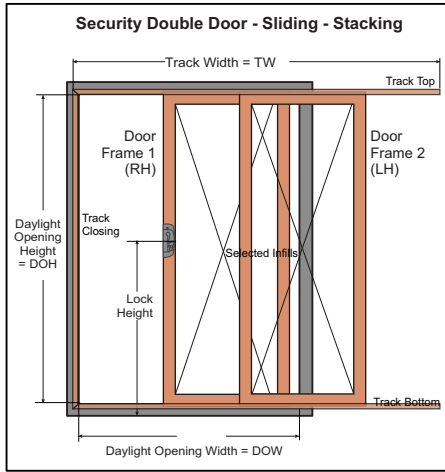
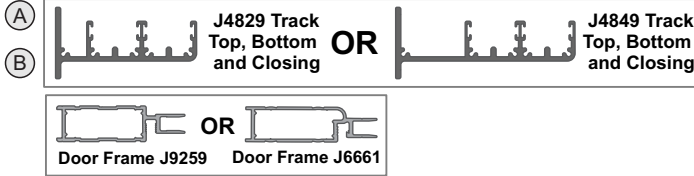

AMPLIMESH DOUBLE/STACKING SLIDING DOOR

Tracks J4829 or J4849

Door Widths can be Equal or Unequal

Components, always needed

HEIGHTS, WIDTHS		Part	Cutting Calc	No
1	Closing Track Height TH	J4829 or J4849	(DOH + 82) = TH	1
2	Woolpile Height	JC225	TH	2
3	Door Frame Height FH	J6661 or J9259	(DOH + 41) = FH	4
1	Track Width TW	J4829 or J4849	Enter Width = TW	2
2	Woolpile Width	JC225	TW	8
3	Door Frame Width EQUAL		(DOW + 27)/2 = FW	4
4	Door Frame Width Unequal FW1	J6661 or J9259	Enter Width =FW1	2
5	Door Frame Width Unequal FW2		(DOW+17-FW1) =FW2	2

Description	Part No	No
1 Kwikfit Rollers	JC206	8
2 Corner Stake HD	JC216	8
3 Track End Caps	JC829 or JC849	2
4 Track End Stop	JC203	1
Select either Flushbolts		
5 Whitco Single Flushbolt	JJH203817	2
6 Austral Double Flushbolt, with Rods	JJMFlushbolt/BLK	1

1	Amplimesh Panel Height	J103....	FH - 120	1
2	Door Interlock Extrusion	J9719	FH	1
3	Wall Interlock Angle	JA128	FH	1
4a	If Insect Mesh, Height	JPS....	FH - 60	1
4b	If Insect Spline, Height	JC/220	FH - 60	2
5a	If Lookout, Panel Height	J301...	FH - 104	1
5b	If Lookout, Glazing Bead Height	JA9840	FH - 100	2
1	Amplimesh Panel Width	J103...	FW - 120	1
2a	If Insect Mesh, Width	JPS....	FW - 60	1
2b	If Insect Spline, Width	JC/220	FW - 60	2
3a	If Lookout Panel, Width	J301...	FW - 104	1
3b	If Lookout, Glazing Bead Width	JA9840	FW - 100	2

+ Security Sliding Door Locks

Choice of Austral Murray SD7, SD8 or Whitco Liechardt.
Associated Cylinders, Multipoint Kits and Black, White, SCC finishes for SD7, SD8
All as per Feb 2020 Price Book

Cutting calculations - These are a guide only, confirm before cutting
Strongly Recommended - Allow +30mm per cut to allow for Trimming/Mitre cuts and on site adjustment

Juralco Amplimesh® Security Door and Window Systems - Sliding Door, Cutting

Amplimesh Double Centre Join Sliding Door

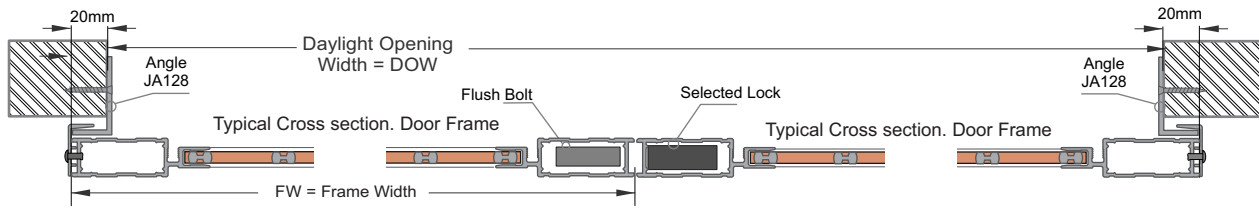
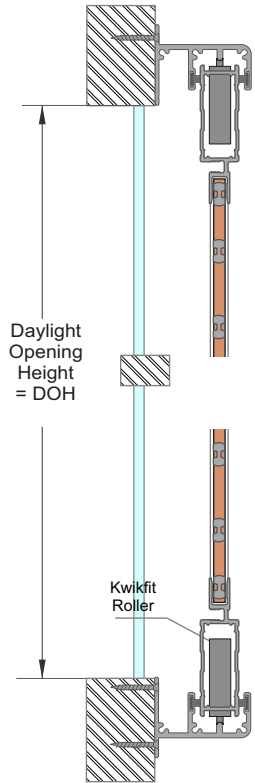
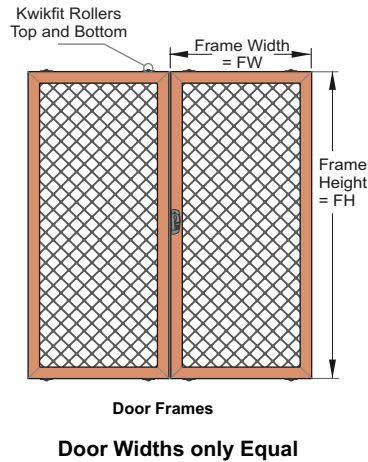
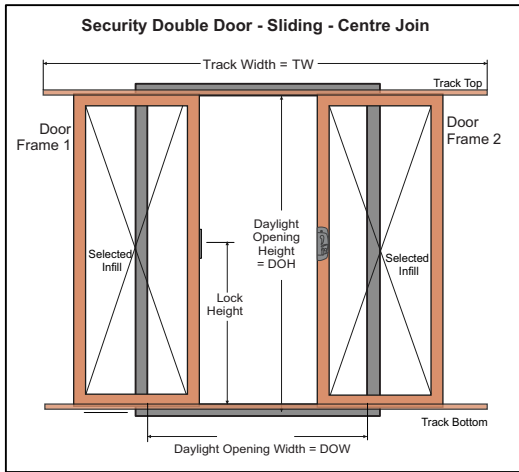
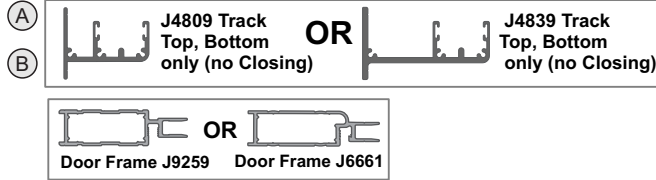

AMPLIMESH DOUBLE/CENTRE JOIN SLIDING DOOR

Tracks J4829 or J4849

Door Widths only Equal

Components, always needed

	HEIGHTS, WIDTHS	Part	Cutting Calc	No
1	Door Frame Height FH	J6661 or J9259	$(DOH + 41) = FH$	4
1	Track Width TW	J4829 or J4849	Enter Width = TW	2
2	Woolpile Width	JC225	TW	4
3	Door Frame Width EQUAL FW	J6661 or J9259	$(DOW + 40)/2 = FW$	4

	Description	Part No	No
1	Kwikfit Rollers	JC206	8
2	Corner Stake HD	JC216	8
3	Track End Caps	JC809 or JC839	2
4	Track End Stop	JC203	1
Select either Flushbolts			
5	Whitco Single Flushbolt	JJH203817	2
6	Austral Double Flushbolt, with Rods	JJMFlushbolt/BLK	1

1	Amplimesh Panel Height	J103....	FH - 120	1
2	Door Interlock Extrusion	J9719	FH	1
3	Wall Interlock Angle	JA128	FH	1
4a	If Insect Mesh, Height	JPS....	FH - 60	1
4b	If Insect Spline, Height	JC/220	FH - 60	2
5a	If Lookout, Panel Height	J301...	FH - 104	1
5b	If Lookout, Glazing Bead Height	JA9840	FH - 100	2
1	Amplimesh Panel Width	J103...	FW - 120	1
2a	If Insect Mesh, Width	JPS....	FW - 60	1
2b	If Insect Spline, Width	JC/220	FW - 60	2
3a	If Lookout Panel, Width	J301...	FW - 104	1
3b	If Lookout, Glazing Bead Width	JA9840	FW - 100	2

+ Security Sliding Door Locks

Choice of Austral Murray SD7, SD8 or Whitco Liechardt.
Associated Cylinders, Multipoint Kits and Black, White, SCC finishes for SD7, SD8
All as per Feb 2020 Price Book

Cutting calculations - These are a guide only, confirm before cutting
Strongly Recommended - Allow +30mm per cut to allow for Trimming/Mitre cuts and on site adjustment



JURALCO

www.juralco.co.nz ph (09) 478 8018

Juralco Amplimesh® Security Door and Window Systems

Issue 3-23 v1
Page 30

Juralco Amplimesh® Security Door and Window Systems - Sliding Door, Machining

Security Sliding Door Machining, Assembly

To conform to AS5039-2008 the Mesh must be rivetted to the Frame
Sliding Door Panel

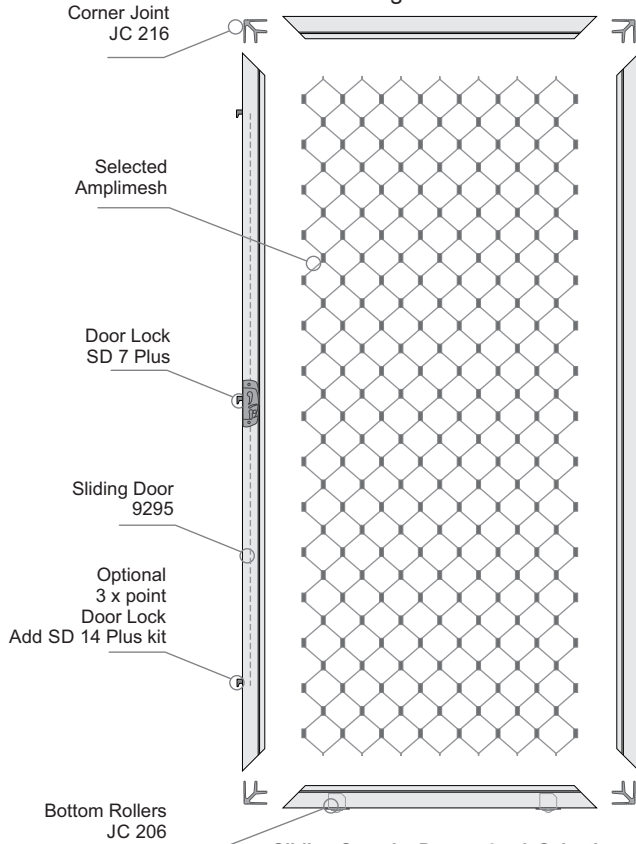

Sliding Security Doors - Lock Selection
 a - Single point Lock - Austral SD 7 Plus
 b - Three point Lock, Cable Drive Austral SD 7 Plus + SD 14 Plus kit

SD7Plus, SD14Plus, Wheel Door Frame Machining

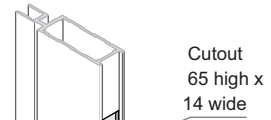

Three point Lock Top Cutout

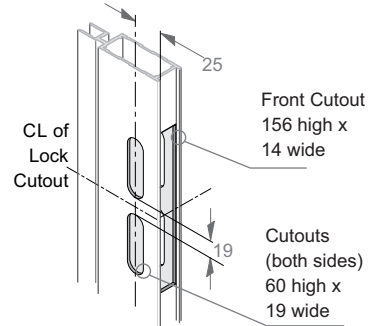

Lock Centre Cutout

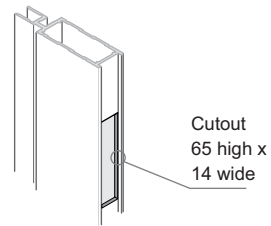

Three point Lock Bottom Cutout

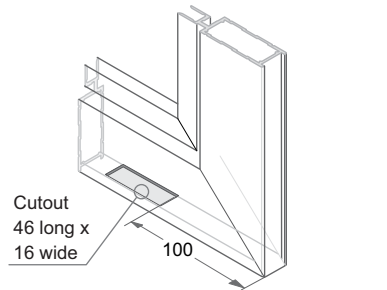

JC 206 Kwikfit Roller Cutout

Sliding Door Panel Corners

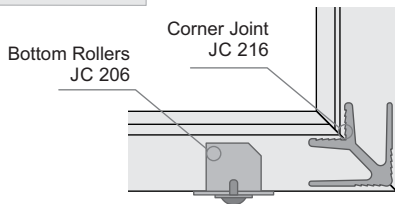

SD14Plus Door Frame Machining Setouts

SD14 - 3 Point Locks Machining Setouts	A dim to Top	B dim to Bottom
High Centre Lock	546	961
Low Centre Lock	961	546
Pool Centre Lock	375	961
Sample Lock	375	375

Setout Tolerances all plus/minus 3mm

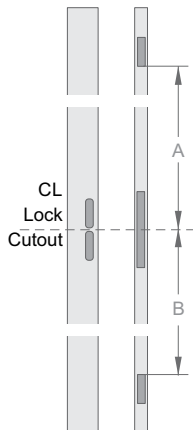

SD14 system

SD Channel Corner Attach

Screw 6g x 25 SS Pan Head

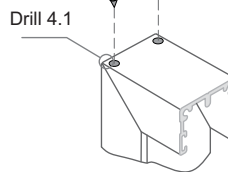

SDC 4559 Corner Attach (screw from top, bottom)

Screw 6g x 25 SS Pan Head

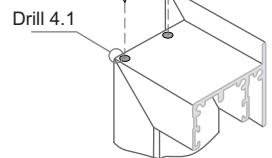

SDC 4809, 4558 Corner Attach (screw from top, bottom)

Amplimesh Sliding Door Installation

- 1 - Check the extrusions supplied are the correct ones for this application, ie. they fit around windows and take account of any restricted clearances around the door frame.
- 2 - Screw the vertical jamb extrusion into position so that the top and bottom tracks can be easily and properly fixed into position.
 - a- The bottom track is usually "top-fixed" extrusion.
 - b - The side and top tracks are usually "sub-fixed" extrusion.
 - c - The miters should be checked to ensure any excess 'wings' are cut off before installation
- 3 - Check the door is the correct size, ie. the door doesn't interfere with any adjacent opening windows.
- 4 - Screw the bottom track into place, making sure it is as close as possible to 90deg with the vertical closing jamb, and running in a straight line without sags or bumps.
- 5 - Place the door onto the bottom track and level up with the closing jamb using the adjustable door rollers.
- 6 - Screw the top track into position, making sure the extrusion sits underneath any opening windows.
- 7 - Mark the door latch position on the closing jamb.
- 8 - Using 2 of 10g x 12mm Pan S/S screws, screw the door latch packer to the closing jamb
- 9 - Screw the door latch to the door latch packer using 2 of 10g x 12mm Pan S/S screws.
fit the brush strip to the back of the door or to the mullion (prefer the mullion if there is an opening window adjacent)
- 10 - Fit Interlock angles to backs of Door and Mullions.
- 11 - Test Doors for smoothness + shutting/locking and full retraction to stops.
- 12 - Always clean off all fingermarks, leave the site clean and tidy.

Amplimesh® Single Door Sliding		SD#
Customer		
Order No	Date	
WO Juralco	SO Juralco	\$ Juralco
Select/Enter Dimensions below. Enter details/selections into all boxes. Then scan and send to sales@juralco.co.nz		

This Order Form - Amplimesh® Single Door, Sliding only.

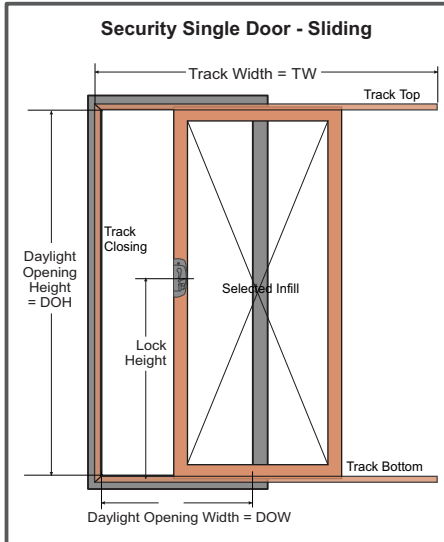

1 Enter Location

Enter Sizes	Dimensions mm	Daylight OH	Daylight OW	Track Width (TW)

2 Duralloy Duralloy Plus Duratec OR Select Anodising

Select Finish Specify PC Colour and Code

Natural
Bronze

3 Select Track Layouts

A	J4558 Track Closing	J4559 Track Top and Bottom	<input type="checkbox"/>						
B	J4558 Track Top and Closing	J4559 Track Bottom	<input type="checkbox"/>						
C	J4558 Track Bottom and Closing	J4559 Track Top	<input type="checkbox"/>						
D	J4809 Track Top, Bottom and Closing		<input type="checkbox"/>						
E	J4839 Track Top, Bottom and Closing		<input type="checkbox"/>						

Select options

Insect Screens (Black)	No	Fibreglass Mesh	Midge Mesh	Petscreen Mesh	Lookout Mesh
	<input type="checkbox"/>	<input type="checkbox"/>	<input type="checkbox"/>	<input type="checkbox"/>	<input type="checkbox"/>
Door Frames	J9295 Square	J6661 Curved			
	<input type="checkbox"/>	<input type="checkbox"/>			
Door Lock Punching	No	Yes	Height	LH or RH Closing	
	<input type="checkbox"/>	<input type="checkbox"/>			

4 Austral Murray SD7 or SD8 Lock Options

Lock Type	SD7	SD8	Lock Finish	White	Black	SCC	Multi Point Kits	High	Low
C4 Cylinders	46mm Wafer Random	5 pin Random 64mm Key	5 pin Keyed alike	6 pin Keyed alike	LH Thumb Turn, Random	RH Thumb Turn, Random			

5 Whitco Liechardt Lock Options (Black only)

Whitco Cylinders	Random Key	Keyed Alike	LH Thumb Turn, Random	RH Thumb Turn, Random	Multi Point (Black)	No	Yes

6 Remarks

Amplimesh® Double Door Sliding/Stacking		SD#
Customer		
Order No	Date	
WO Juralco	SO Juralco	\$ Juralco
Select/Enter Dimensions below. Enter details/selections into all boxes. Then scan and send to sales@juralco.co.nz		

This Order Form - Amplimesh® Double Door/Stacking, Sliding only.

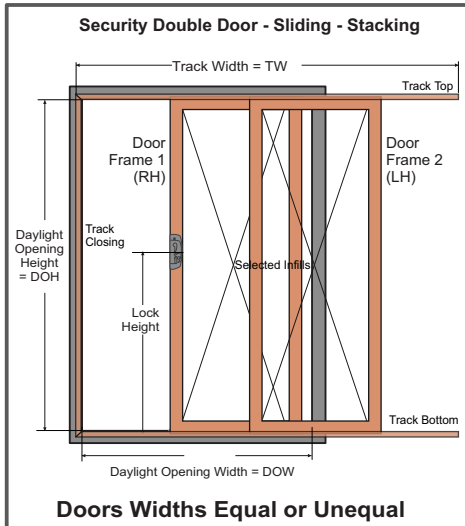

1 Enter Location

Enter Sizes	Dimensions mm	Daylight OH	Daylight OW	Track Width (TW)	Max DOH, DOW - Height 2490mm - Width 2530mm
	<input style="width: 100%;" type="text"/>	<input style="width: 100%;" type="text"/>	<input style="width: 100%;" type="text"/>	<input style="width: 100%;" type="text"/>	

2 Duralloy Duralloy Plus Duratec OR Select Anodising

Select Finish Specify PC Colour and Code

Natural
Bronze

4 Door Widths Equal or Unequal

Tick if Equal

If Unequal Enter Width Door Frame 1 (LH)

If Unequal Enter Width Door Frame 2 (RH)

Note: Door Frame Widths 1280mm max

3 Select Track Layouts

A **J4829 Track Top, Bottom and Closing**

B **J4849 Track Top, Bottom and Closing**

Select options

Insect Screens (Black)	No	Fibreglass Mesh	Midge Mesh	Petscreen Mesh	Lookout Mesh
	<input type="checkbox"/>	<input type="checkbox"/>	<input type="checkbox"/>	<input type="checkbox"/>	<input type="checkbox"/>

Door Frames	J9295 Square	J6661 Curved
	<input type="checkbox"/>	<input type="checkbox"/>

Door Lock Punching	No	Yes	Height	LH or RH Closing
	<input type="checkbox"/>	<input type="checkbox"/>	<input style="width: 100%;" type="text"/>	<input type="checkbox"/>

5 Austral Murray SD7 or SD8 Lock Options

Lock Type	SD7	SD8	Lock Finish	White	Black	SCC	Multi Point Kits	High	Low
	<input type="checkbox"/>	<input type="checkbox"/>		<input type="checkbox"/>	<input type="checkbox"/>	<input type="checkbox"/>		<input type="checkbox"/>	<input type="checkbox"/>

C4 Cylinders	46mm Wafer Random	5 pin Random 64mm Key	5 pin Keyed alike	6 pin Keyed alike	LH Thumb Turn, Random	RH Thumb Turn, Random
--------------	-------------------	-----------------------	-------------------	-------------------	-----------------------	-----------------------

6 Whitco Liechardt Lock Options (Black only)

Whitco Cylinders	Random Key	Keyed Alike	LH Thumb Turn, Random	RH Thumb Turn, Random	Multi Point (Black)	No	Yes
	<input type="checkbox"/>	<input type="checkbox"/>	<input type="checkbox"/>	<input type="checkbox"/>		<input type="checkbox"/>	<input type="checkbox"/>

7 Remarks

Amplimesh® Double Door Sliding/Centre Join		SD#
Customer		
Order No	Date	
WO Juralco	SO Juralco	\$ Juralco
Select/Enter Dimensions below. Enter details/selections into all boxes. Then scan and send to sales@juralco.co.nz		

This Order Form - Amplimesh® Double Door/Centre Join, Sliding only.

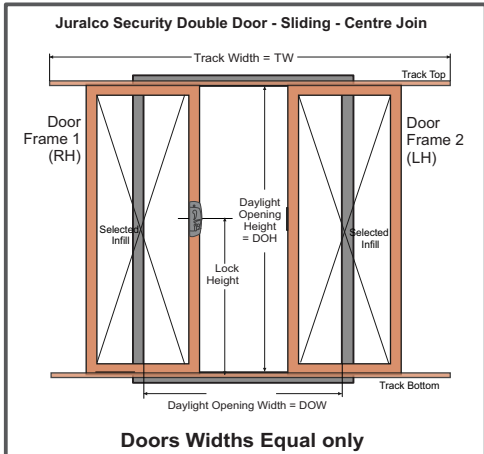

1 Enter Location

Enter Sizes	Dimensions mm	Daylight OH	Daylight OW	Track Width (TW)	Max DOH, DOW - Height 2490mm - Width 2530mm

2 Duralloy Duralloy Plus Duratec OR Select Anodising

Select Finish Specify PC Colour and Code

Natural
Bronze

3 Select Track Layouts, Options

A **J4809 Track. Top, Bottom and Closing**

B **J4839 Track. Top, Bottom and Closing**

Select options					
Insect Screens (Black)	No	Fibreglass Mesh	Midge Mesh	Petscreen Mesh	Lookout Mesh
Door Frames	J9295 Square	J6661 Curved			
Door Lock Punching	No	Yes	Height	LH or RH Frame	
Whitco Flush Bolts	Singles x 2		Double		

5 Austral Murray SD7 or SD8 Lock Options

Lock Type	SD7	SD8	Lock Finish	White	Black	SCC	Multi Point Kits	High	Low
C4 Cylinders	46mm Wafer Random	5 pin Random 64mm Key	5 pin Keyed alike	6 pin Keyed alike	LH Thumb Turn, Random	RH Thumb Turn, Random			

6 Whitco Liechardt Lock Options (Black only)

Whitco Cylinders	Random Key	Keyed Alike	LH Thumb Turn, Random	RH Thumb Turn, Random	Multi Point (Black)	No	Yes

7 Remarks

Juralco Amplimesh® Security Door and Window Systems - Insect Screen Options

Door Insect Screen Extrusions (for all Meshes, incl Lookout)

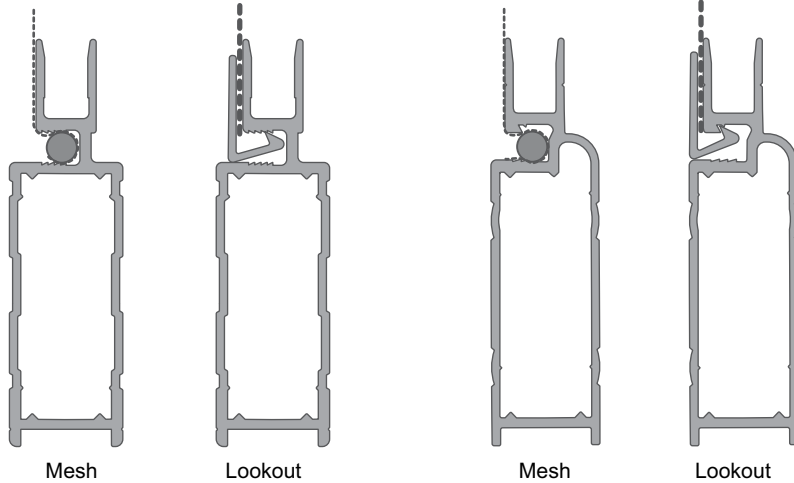

HINGED and SLIDING
DOOR FRAME
Part No J9295

HINGED and SLIDING
DOOR FRAME
Part No J6661

Window Insect Screen Extrusions (for Fibreglass and Midge mesh only)

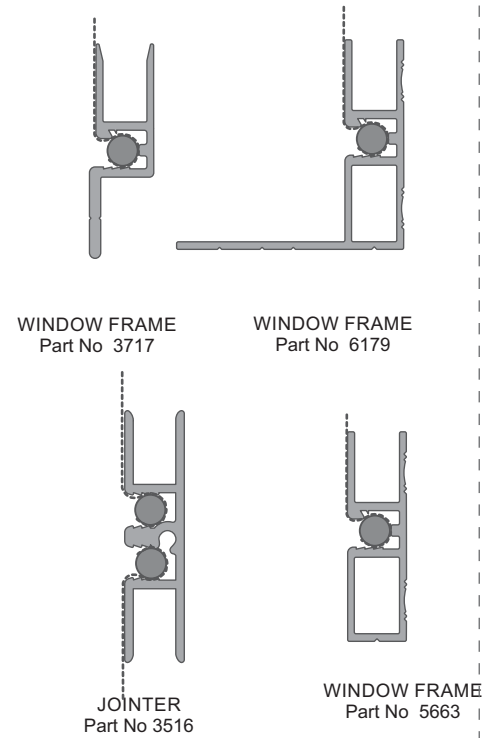

WINDOW FRAME
Part No 3717

WINDOW FRAME
Part No 6179

JOINTER
Part No 3516

WINDOW FRAME
Part No 5663

Insect Screen Spline Sizes

- Recommended splines
- For all Fibreglass mesh 6.3mm
 - For all Petscreen mesh 6.0mm



LOOKOUT
GLAZING BEAD
Part No J9840
(Doors only)

Insect Mesh Installation

- 1 - Lay the finished frame on a flat surface and drape the selected mesh over it.
- 2 - Cut the mesh on three sides to the outside edge of the frame but on the 4th side allow a generous 75-80mm overlap to enable the fabric to be stretched tight.
- 3 - Warm the PVC spline in hot water to make it more pliable so it is easier to manipulate. Use your fingers to work it into position.
- 4 - Start about 90mm from the corner and at the opposite end to the one that has the extra allowances for stretching.
- 5 - Use the spline roller to press the PVC spline into the slot.
- 6 - After completing one end, stretch the mesh tight whilst at the same time inserting the spline into the remaining 3 sides.
- 7 - Trim the excess with a sharp knife.

Insect Screen Materials Splines, Meshes

Insect Windows. Fibreglass and Midge Meshes only

Insect Doors All Meshes incl Lookout

Splines x 300m Roll		Fibreglass Mesh - 65% open		Midge Mesh - 45% open		Petscreen Mesh - 36% open		Lookout Mesh Panels	
Part No	Spline dia	Black 17x14x0.28mm 50m Roll		Black 20x20x0.3mm 30m Roll		Black 17x10x0.64mm 2.1m Roll		Black/SCC 17x14x0.11mm	
		Part No	Width	Part No	Width	Part No	Width	Part No	Panel
JC221/300/Black	4.6mm	JPSFG/810/50	810mm	JPSNU/1220/30	810mm	JPSPP/910/2.1	910mm	J301A/2000	2m x 750mm
JC220/300/Black	5.0mm	JPSFG/910/50	910mm			JPSPP/1220/2.1	1220mm	J301D/2200	2.2m x 12200mm
JC228/300/Black	5.5mm	JPSFG/1220/50	1220mm			Black 17x10x0.64mm 30m Roll			
JC227/300/Black	6.0mm	JPSFG/1830/50	1830mm			JPSPP/910/30	910mm		
JC222/300/Black	6.3mm	JPSFG/2130/50	2130mm			JPSPP/1220/30	1220mm		
JC2231/300/Black	6.5mm								

Powder Coating Installation Care

Warning re use of solvents:

- In some cases strong solvents are recommended for thinning various types of paints and also for cleaning up mastics and sealants.
- These can be harmful to the extended life of the powder coated surface, and must not be used for cleaning purposes.
- It is important to note that the damage will not be visible immediately and may take up to 12 months to develop.

If paint splashes or sealants and mastics need to be removed then the following may be safely used:
Methylated Spirits, Ethyl Alcohol, Isopropanol or preferably a mild detergent in warm water.

Joinery Protection during Installation:

All the activity on a construction site means that your powder coated items may get knocked or scratched, splattered with mortar, plaster, textured coating or paint during the later stages of construction.

Please ensure that all powder coated articles are masked or covered at this time. It is far easier to prevent accidents than to try and correct them. Should your joinery receive mortar or paint splashes see that these are removed before cure and follow the instructions contained in this brochure.

Typical sticker used to warn other trades of the need to protect and mask off powder coated joinery (applies to anodised joinery also)

"IMPORTANT ALL TRADES"
This valuable aluminium joinery will suffer permanent damage from: plaster, mortar and paint splashes - Protect if splashes occur - Immediately wash down joinery with water or meths - Do not allow splashes to harden! - Do not use solvents! - Do not remove this label until final clean completed.

This photograph displays damage that has occurred on site, post installation. The photo of the masked joinery displays clear signs of damage that could have occurred were it not masked. Please ensure that your joinery is protected right through the entire construction process.



Powder Coating Maintenance

External - Maintenance Program:

To extend the life of external powder coated articles and to comply with warranty requirements for powder coated aluminium joinery, a simple, regular maintenance program must be implemented.

The effects of ultra violet light, atmospheric pollution, dirt, grime and airborne salt deposits will all accumulate over time and must be removed or surface staining and weathering will occur, leading to an unsightly appearance.

For external coatings, cleaning should take place every six months. In areas where pollutants are more prevalent, such as beachfront houses and industrial or geothermal areas, then a cleaning program should be carried out on a more frequent basis ie. every one to three months.

Cleaning your powder coating:

1. Carefully remove any loose surface deposits with a wet sponge.
2. Use a soft brush (non abrasive) and a mild household detergent (do not use solvents) in warm water, remove dust, salt and other deposits.
3. Rinse off with clean fresh water.



Restoring weathered or scratched surfaces:

Repair of Scuffed or Scratched surfaces
Dulux Spray Cans are available in all colour card colours.

Repair of Small Scratches or Chips.
Dulux Dabsticks are ideally suited for the repair of small scratches.
Dabsticks may not be available in all colour card colours.

Repair of Weathered areas .
Dulux Gloss Up is a light to medium cutting cream ideally suited for gloss restoration and has been specifically designed for this purpose.
Gloss Up contains no waxes or silicone and is a one step system.



Contact Dulux Powder Coatings , ph 0664 9 441 8244

All pages © Copyright Juralco Aluminium Building Products Ltd, 2023