

*Applicable to 12mm and 24mm

PACK INCLUDES

MATRIX BAFFLES

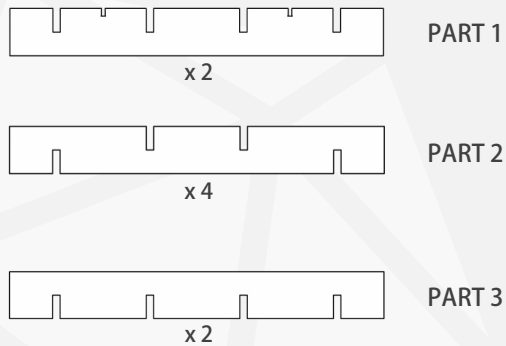

CEILING STENCIL

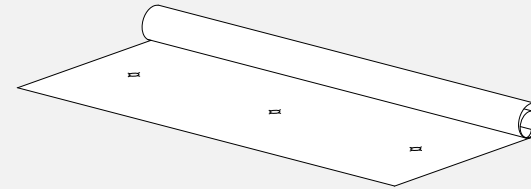

SCREWS

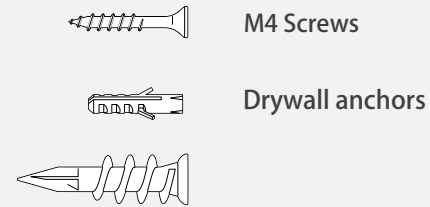

SUSPENDED FIX x 4

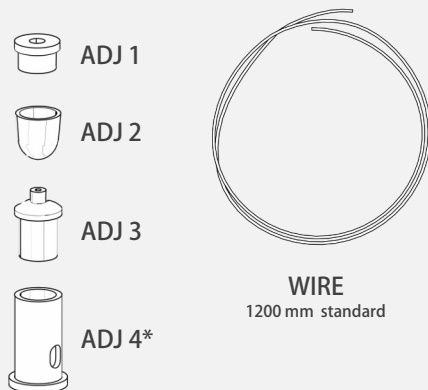

*Already attached to Matrix

NOT INCLUDED

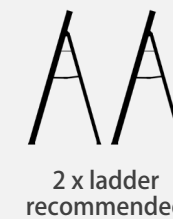
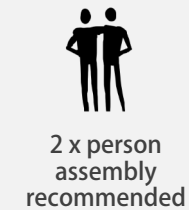
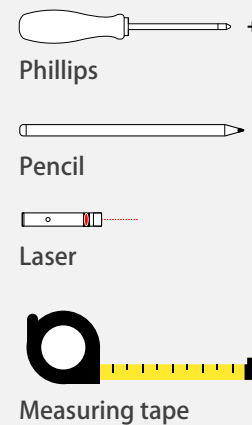

*Applicable to all sizes

LASER METHOD 1.

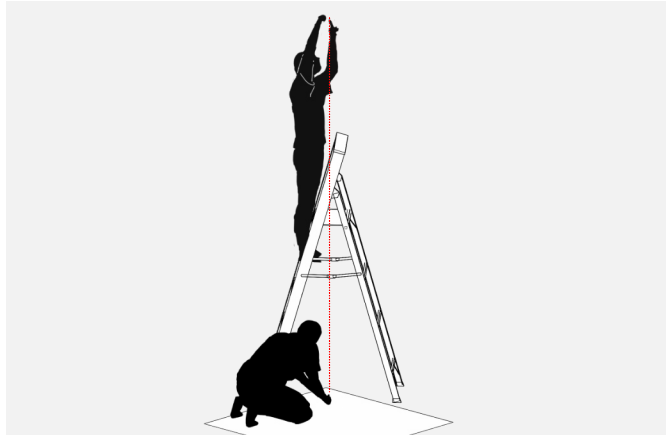

Lay supplied stencil on ground directly below ceiling surface you would like to install your Vista panel. Point laser vertically on each marked spot on the stencil while the second person marks the laser spots on the ceiling using a ladder. Apply this method to each attachment spot.

MANUAL METHOD 1.



Hold stencil to ceiling, marking all fitment locations on ceiling.
If unable to use stencil, use measurements marked on stencil and manually measure and transfer markings.

SUSPENDED FIX 2.

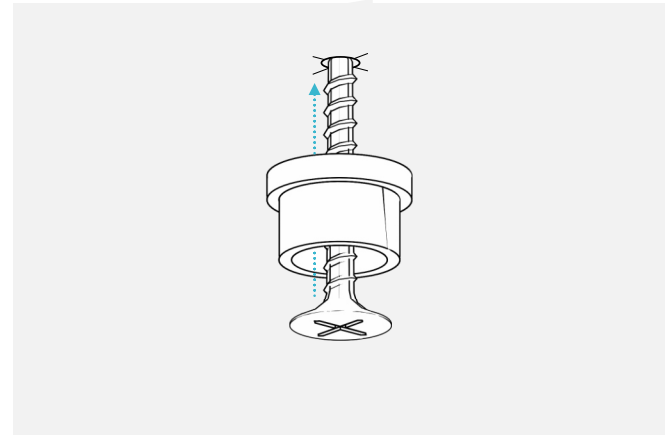

Insert supplied screws* into adjustment 1 and screw into ceiling at marked spots.

*Use appropriate anchor depending on ceiling material.

*Applicable to 12mm and 24mm

Assemble me near place of installation!

1.

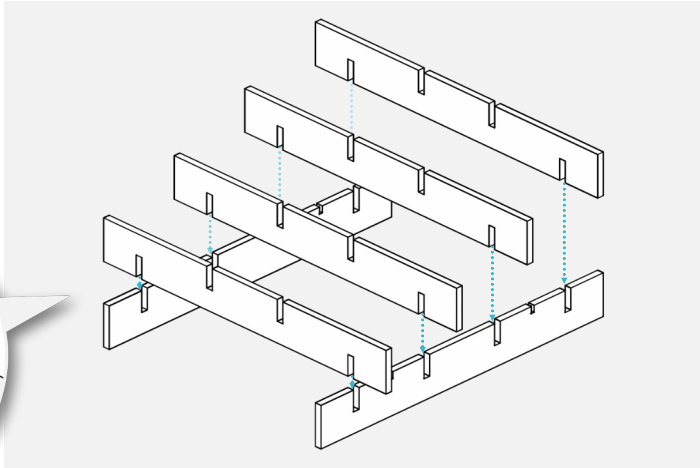

Place 2 x (Part 1) on flat surface.
Align 4 x (Part 2) perpendicular to part 1.
Slide into all slots until flush.

2.

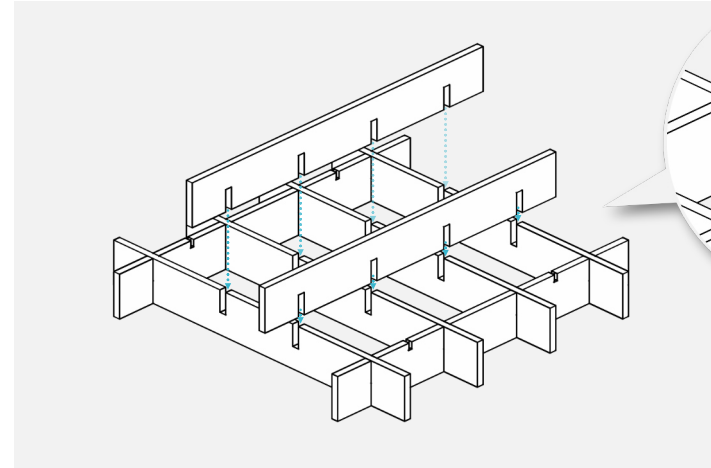

Align 2 x (Part 3) parallel with Part 1.
Slide into all slots until flush.
When slotting in the fins, push down gently and evenly across length to avoid damage.

3.

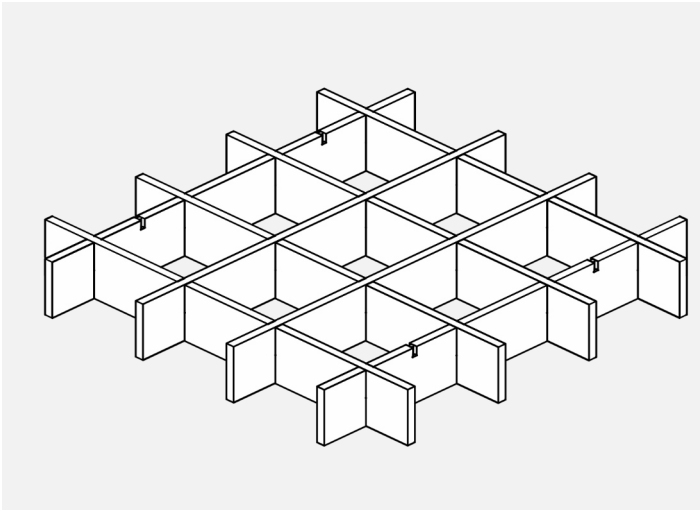

Finished baffle without wire attachment.

5.

Tip!
To extend, pull metal gizmo with finger nail to release wire

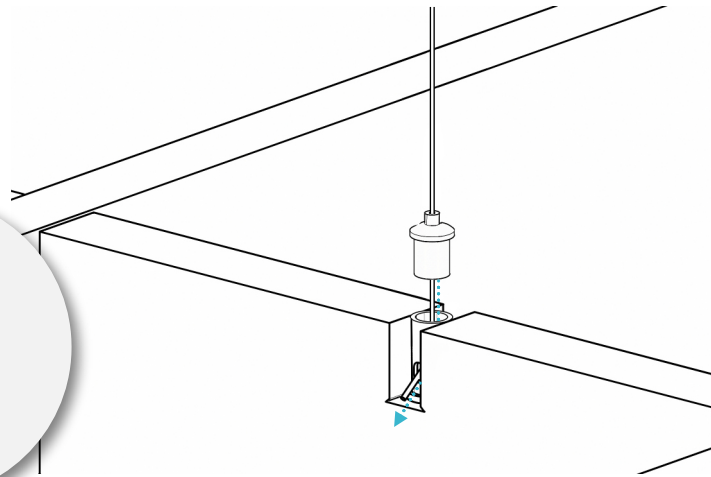
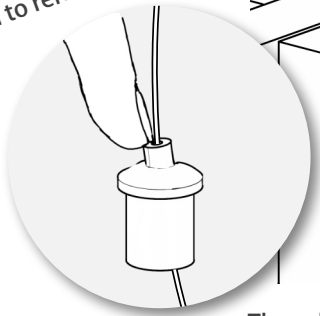

Thread wire a few inches through Adjustment 3. Insert wire through adjustment 4. Screw both adjustments till tight.

5.A.

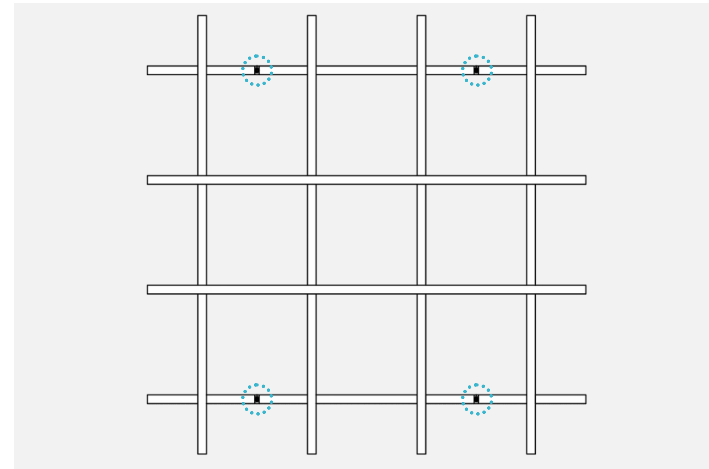

*Recommended distance from ceiling: 250mm

Apply this to all 6 fitment spots. Adjust all wires to the desired height using accurate measuring*

6.



Using responsible safety measures, lift to designated spot using two people. Screw all 6 of adjustment 2 into all 6 of adjustment 1 to ceiling. Attach opposite corners first then move on to the rest.

7.

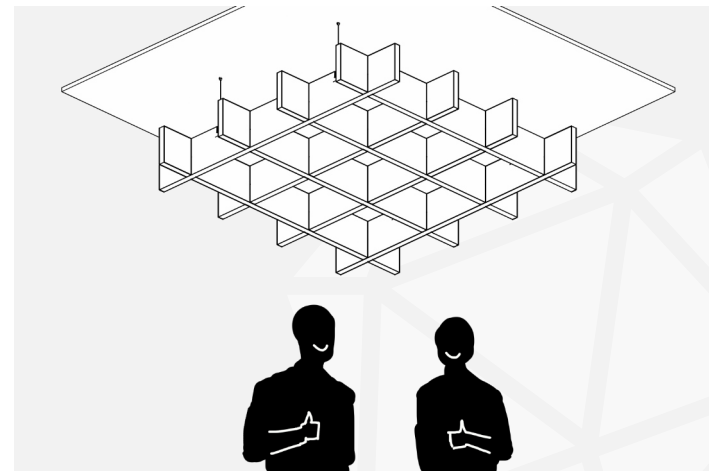

Adjust wire length if needed. Enjoy your finished Matrix