

Elephant
Plasterboard



EPB

Plasterboard & Fibre Cement FIRE RATED SYSTEMS

October 2024

www.elephantplasterboard.co.nz

EPB Plasterboard & Fibre Cement Fire Rated Systems Manual

These publications are continuously being updated and superseded. CURRENT VERSION DATED: **October 2024**

It is important to check to ensure you have the latest publication. Call Free Help line 0800 353742.

Liability for systems that are not designed and installed in accordance with this publication will not be accepted by Elephant Plasterboard (NZ) Limited.

Copyright

All the material in this document including text, diagrams, figures, patterns, pictures, tables and cad drawings are protected by copyright.

Cad Drawings

Pictures and CAD drawings may be downloaded and used in consented plans for generic references only. Elephant Plasterboard (NZ) Limited takes no liability in CAD drawing details shown. It is up to the designer and or builder to provide specific details and or building construction methods in each case. All pictures and CAD details are generic only.

Elephant Plasterboard (NZ) Limited Trademarks:

Elephant Plasterboard[®], Elephant Board[®], EPB Plasterboard[®]

Elephant Standard Plasterboard[®], Elephant Smartboard[®], SmartRock Plasterboard[®]

Elephant FireSmart[®], Elephant MultiSmart[®], Elephant AquaSmart[®], Elephant CeilingSmart[®], Elephant SpanSmart[®], Elephant SuperSmart[®], Elephant BraceSmart[®], Elephant NoiseSmart[®], Elephant UltraSmart[®], Elephant Standard-Plus[®], Elephant ImpactSmart[®], EPB Standard[®], EPB MultiSmart[®], EPB FireSmart[®], EPB AquaSmart[®], EPB CeilingSmart[®]

Introducing new 10mm EPB FireSmart/10mm EPB CeilingSmart[®]

10mm EPB FireSmart is a higher density board compared to 10mm EPB Standard and provides enhanced fire performance.

10mm EPB CeilingSmart is especially developed to span ceiling battens at 600mm centres providing a light weight and cost effective ceiling lining solution compared to using 10mm Standard Plasterboard at 450mm centres or 13mm Standard Plasterboard at 600mm centre.

All past and future references and installations of 10mm Standard-Plus is interchangeable with 10mm EPB FireSmart and vice versa.

Elephant Plasterboard Product & System Warranty

EPB Plasterboard wall and ceiling linings are supported by Elephant Plasterboard's Quality Guarantee. This Warranty covers Elephant Plasterboard products and or systems for a minimum of 10 years from the date of the purchase. Elephant Plasterboard supplies products which are warranted to be free from defects. Any products found to be defective before or after installation will be replaced and/or repaired, provided installation has been in accordance with EPB Plasterboard's technical literature.

James Hardie fire and acoustic performance, durability and maintenance requirements of James Hardie products, components or systems do not form a part of this Elephant Plasterboard warranty.

For warranty terms & conditions on James Hardie products & components, visit www.jameshardie.co.nz.

Free Helpline

0800 353-742

Email

info@elephantplasterboard.co.nz

Website

www.elephantplasterboard.co.nz

Telephone

(09) 818-7706

Elephant Plasterboard (NZ) Limited

14 Bancroft Crescent, Glendene, Auckland 0602

P.O. Box 21-436, Waitakere 0650

New Zealand



CONTENTS

SYSTEM SELECTOR TABLE	4-22
INTRODUCTION	24-29
<ul style="list-style-type: none"> Limitations and Conditions of Use NZBC Compliance Fire Resistance Ratings (FRR) Internal lining Surface Finish Properties Control of External Fire Spread EPB & Fibre Cement Fire Rated Walls - Timber Frame EPB & Fibre Cement Fire Rated Walls - Steel Frame Thermal Fire Batten Structural Steel Members in Fire Rated Walls Cavity Insulation Fire Retardant Flexible Underlay Rigid Air Barrier EPB QuickBrace System EPB & Fibre Cement Fire Rated Floor/Ceiling Product & Component Substitution James Hardie Cladding Options & Technical Literature 	
NOMENCLATURE	30
<ul style="list-style-type: none"> EPB Specification Reference - Fire Wall with Fibre Cement EPB Specification Reference - Floor/Ceilings with Fibre Cement 	
EXTERNAL TIMBER FRAME WALLS	31-60
<ul style="list-style-type: none"> EPB & James Hardie Linea™ Weatherboard EPB & James Hardie Linea™ Oblique™ Weatherboard EPB & James Hardie™ Plank Weatherboard EPB & James Hardie Stria™ Cladding EPB & James Hardie Stria™ Cladding & RAB™ Board EPB & James Hardie Hardie™ Flex Sheet EPB & James Hardie Axon™ Panel EPB & James Hardie Axon™ Panel & RAB™ Board EPB & James Hardie EasyLap™ Panel EPB & James Hardie EasyLap™ Panel & RAB™ Board EPB & James Hardie ExoTec™ Facade Panel & RAB™ Board EPB & James Hardie RAB™ Board & a Weathertight Cladding 	
EXTERNAL STEEL FRAME WALLS	61-73
<ul style="list-style-type: none"> EPB & RAB™ Board with Selected James Hardie Fibre Cement Cladding EPB & James Hardie RAB™ Board & a Weathertight Cladding 	
INTERNAL TIMBER FRAME WALLS	74-76
<ul style="list-style-type: none"> EPB Plasterboard & James Hardie Villaboard™ Lining 	
FLOOR/CEILING SYSTEMS	77-79
<ul style="list-style-type: none"> EPB Plasterboard & Secura™ Interior Flooring 	
FLOATING FLOOR/CEILING SYSTEMS	81-83
<ul style="list-style-type: none"> EPB Plasterboard & Floating Secura™ Interior Flooring 	
CONSTRUCTION DETAIL	84-96
PRODUCT RANGE	98



External Fire Rated Walls - Timber Frame

System Number	Lining Suffix	FRR	Insulation	Noise Control STC	Lining Requirements	Page
EPB Plasterboard & James Hardie Linea™ Weatherboard						
EJL1TL30	-F10	30/30/30	R2.2 glass wool	46	1 x 10mm EPB FireSmart on Internal side James Hardie Linea™ Weatherboard to External side	32
EJL1TL60	-M13	60/60/60	R2.2 glass wool	47	1 x 13mm EPB MultiSmart on Internal side James Hardie Linea™ Weatherboard to External side	33
EPB Plasterboard & James Hardie Linea™ Oblique™ Weatherboard						
EJOH1TL30	-F10	30/30/30	R2.2 glass wool	46	1 x 10mm EPB FireSmart on Internal side James Hardie Linea™ Oblique™ Weatherboard horizontal to External side	34
EJOv1TL30	-F10	30/30/30	R2.2 glass wool	46	1 x 10mm EPB FireSmart on Internal side James Hardie Linea™ Oblique™ Weatherboard vertical to External side	35
EJOH1TL60	-M13	60/60/60	R2.2 glass wool	47	1 x 13mm EPB MultiSmart on Internal side James Hardie Linea™ Oblique™ Weatherboard horizontal to External side	36
EJOv1TL60	-M13	60/60/60	R2.2 glass wool	47	1 x 13mm EPB MultiSmart on Internal side James Hardie Linea™ Oblique™ Weatherboard vertical to External side	37
EPB Plasterboard & James Hardie™ Plank Weatherboard						
EJW1TL30	-F10	30/30/30	R2.2 glass wool	45	1 x 10mm EPB FireSmart on Internal side James Hardie™ Plank Weatherboard to External side	38
EJW1TL60	-M13	60/60/60	Hardie™ Mineral	46	1 x 13mm EPB MultiSmart on Internal side James Hardie™ Plank Weatherboard to External side	39
EPB Plasterboard & James Hardie Stria™ Cladding						
EJSh1TL30	-F10	30/30/30	R2.2 glass wool	46	1 x 10mm EPB FireSmart on Internal side James Hardie Stria™ Cladding horizontal to External side	40
EJSv1TL30	-F10	30/30/30	R2.2 glass wool	46	1 x 10mm EPB FireSmart on Internal side James Hardie Stria™ Cladding vertical to External side	41
EJSh1TL60	-M13	60/60/60	R2.2 glass wool	47	1 x 13mm EPB MultiSmart on Internal side James Hardie Stria™ Cladding horizontal to External side	42
EJSv1TL60	-M13	60/60/60	R2.2 glass wool	47	1 x 13mm EPB MultiSmart on Internal side James Hardie Stria™ Cladding vertical to External side	43
EPB Plasterboard & James Hardie Stria™ Cladding & RAB™ Board with CLD Battens						
EJRS1TL30	-F10	30/30/30	R2.2 glass wool	46	1 x 10mm EPB FireSmart on Internal side James Hardie Stria™ Cladding and RAB™ Board with CLD™ Structural Cavity Batten to External side	44
EJRS1TL60	-M13	60/60/60	Hardie™ Mineral	47	1 x 13mm EPB MultiSmart on Internal side James Hardie Stria™ Cladding and RAB™ Board with CLD™ Structural Cavity Batten to External side	45
EPB Plasterboard & James Hardie Hardie™ Flex Sheet						
EJF1TL30	-F10	30/30/30	R2.2 glass wool	42	1 x 10mm EPB FireSmart on Internal side James Hardie Hardie™ Flex Sheet to External side	46
EJF1TL60	-M13	60/60/60	Hardie™ Mineral	43	1 x 13mm EPB MultiSmart on Internal side James Hardie Hardie™ Flex Sheet to External side	47



External Fire Rated Walls - Timber Frame

System Number	Lining Suffix	FRR	Insulation	Noise Control STC	Lining Requirements	Page
EPB Plasterboard & James Hardie Axon™ Panel						
EJA1TL30	-F10	30/30/30	R2.2 glass wool	41	1 x 10mm EPB FireSmart on Internal side James Hardie Axon™ Panel to External side	48
EJA1TL60	-M13	60/60/60	Hardie™ Mineral	42	1 x 13mm EPB MultiSmart on Internal side James Hardie Axon™ Panel to External side	49
EPB Plasterboard & James Hardie Axon™ Panel & RAB™ Board with CLD Battens						
EJRA1TL30	-F10	30/30/30	R2.2 glass wool	45	1 x 10mm EPB FireSmart on Internal side James Hardie Axon™ Panel and RAB™ Board with CLD™ Structural Cavity Batten to External side	50
EJRA1TL60	-M13	60/60/60	Hardie™ Mineral	46	1 x 13mm EPB MultiSmart on One side James Hardie Axon™ Panel and RAB™ Board with CLD™ Structural Cavity Batten to External side	51
EPB Plasterboard & James Hardie EasyLap™ Panel						
EJE1TL30	-F10	30/30/30	R2.2 glass wool	46	1 x 10mm EPB FireSmart on Internal side James Hardie EasyLap™ Panel to External side	52
EJE1TL60	-M13	60/60/60	Hardie™ Mineral	47	1 x 13mm EPB MultiSmart on Internal side James Hardie EasyLap™ Panel to External side	53
EPB Plasterboard & James Hardie EasyLap™ Panel & RAB™ Board with CLD Battens						
EJRE1TL30	-F10	30/30/30	R2.2 glass wool	46	1 x 10mm EPB FireSmart on Internal side James Hardie EasyLap™ Panel and RAB™ Board with CLD™ Structural Cavity Batten to External side	54
EJRE1TL60	-M13	60/60/60	Hardie™ Mineral	47	1 x 13mm EPB MultiSmart on Internal side James Hardie EasyLap™ Panel and RAB™ Board with CLD™ Structural Cavity Batten to External side	55
EPB Plasterboard & James Hardie ExoTec™ Facade Panel & RAB™ Board						
EJRX1TL30	-F10	30/30/30	R2.2 glass wool	47	1 x 10mm EPB FireSmart on Internal side James Hardie ExoTec™ Facade Panel and RAB™ Board with Top hat system to External side	56
EJRX1TL60	-M13	60/60/60	Hardie™ Mineral	48	1 x 13mm EPB MultiSmart on Internal side James Hardie ExoTec™ Facade Panel and RAB™ Board with Top hat system to External side	57
EPB Plasterboard & James Hardie RAB™ Board & a Weathertight Cladding (See Note 1)						
EJRN1TL30	-F10	30/30/30	R2.2 glass wool	42	1 x 10mm EPB FireSmart on Internal side James Hardie RAB™ Board with a Weathertight Cladding to External side	58
EJRN1TL60	-M13	60/60/60	Hardie™ Mineral	42	1 x 13mm EPB MultiSmart on Internal side James Hardie RAB™ Board with a Weathertight Cladding to External side	59
EJRN2TL60	-F20	60/60/60	Hardie™ Mineral	46	2 x 10mm EPB FireSmart on Internal side James Hardie RAB™ Board with a Weathertight Cladding to External side	60
	-S26	60/60/60	Hardie™ Mineral	47	2 x 13mm EPB Standard on Internal side James Hardie RAB™ Board with a Weathertight Cladding to External side	60
	-M20	60/60/60	Hardie™ Mineral	47	2 x 10mm EPB MultiSmart on Internal side James Hardie RAB™ Board with a Weathertight Cladding to External side	60

Note 1: It is important to consider that the fire properties of the external cladding is in accordance with NZBC C/VM1 or C/AS documents. Refer to Table 5.1 of Section 5.4 of C/AS1 and Table 5.5 of Section 5.8.1 of C/AS2 for the information about various risk groups to identify the external fire spread safety requirement applicable to the exterior surface finishes.



External Fire Rated Walls - Steel Frame

System Number	Lining Suffix	FRR	Insulation	Noise Control	Lining Requirements	Page
				STC		

EPB Plasterboard & RAB™ board with Selected James Hardie Fibre Cement Cladding

EJRH1SL30	-M13	30/30/30	Hardie™ Mineral	42 - 47	1 x 13mm EPB MultiSmart on Internal side James Hardie RAB™ Board with Selected James Hardie Fibre Cement cladding to External side	62
	-F16	30/30/30	Hardie™ Mineral	42 - 47	1 x 16mm EPB FireSmart on Internal side James Hardie RAB™ Board with Selected James Hardie Fibre Cement cladding to External side	62
EJRH2SL30	-F20	30/30/30	Hardie™ Mineral	47 - 53	2 x 10mm EPB FireSmart on Internal side James Hardie RAB™ Board with Selected James Hardie Fibre Cement cladding to External side	64
EJRH2SL60	-M26	60/60/60	Hardie™ Mineral	51 - 54	2 x 13mm EPB MultiSmart on Internal side James Hardie RAB™ Board with Selected James Hardie Fibre Cement cladding to External side	66

EPB Plasterboard & James Hardie RAB™ Board & a Weathertight Cladding (See Note 1)

EJRN1SL30	-M13	30/30/30	Hardie™ Mineral	42	1 x 13mm EPB MultiSmart on Internal side James Hardie RAB™ Board with a Weathertight Cladding to External side	68
	-F16	30/30/30	Hardie™ Mineral	43	1 x 16mm EPB FireSmart on Internal side James Hardie RAB™ Board with a Weathertight Cladding to External side	68
EJRN2SL30	-F20	30/30/30	Hardie™ Mineral	47	2 x 10mm EPB FireSmart on Internal side James Hardie RAB™ Board with a Weathertight Cladding to External side	70
EJRN2SL60	-M26	60/60/60	Hardie™ Mineral	49	2 x 13mm EPB MultiSmart on Internal side James Hardie RAB™ Board with a Weathertight Cladding to External side	72

Internal Fire Rated Walls - Timber Frame

System Number	Lining Suffix	FRR	Insulation	Noise Control	Lining Requirements	Page
				STC		

EPB Plasterboard & James Hardie Villaboard™ Lining

EJV1TL30	-F10	30/30/30	R2.2 glass wool	42	1 x 10mm EPB FireSmart one side James Hardie Villaboard™ Lining other side	75
EJV1TL60	-M13	60/60/60	Hardie™ Mineral	43	1 x 13mm EPB MultiSmart one side James Hardie Villaboard™ Lining other side	76



Floor/Ceilings - Timber Frame

System Number	Lining Suffix	FRR	Insulation	Noise Control		Lining Requirements to underside of Frame	Page
				STC	IIC		
EPB Plasterboard & James Hardie Secura™ Interior Flooring							
EJS1FC30	-M13	30/30/30	n/a	45	33	1 x 13mm EPB MultiSmart to underside of frame	78
EJS1FC60	-F16	60/60/60	n/a	46	33	1 x 16mm EPB FireSmart to underside of frame	79

Full Intertenancy - Floating Floor/Ceilings - Timber Frame

System Number	Lining Suffix	FRR	Insulation	Noise Control		Lining Requirements to underside of Frame	Page
				STC	IIC		
EPB Plasterboard & Floating James Hardie Secura™ Interior Flooring							
EFJ2DFA60	-MS26	60/60/60	R1.8 glass wool	67	57-76	1 x 13 EPB MultiSmart And 1 x 13 EPB Standard under the battens	82
	-M26	60/60/60	R1.8 glass wool	68	57-77	2 x 13 EPB MultiSmart under the battens	82



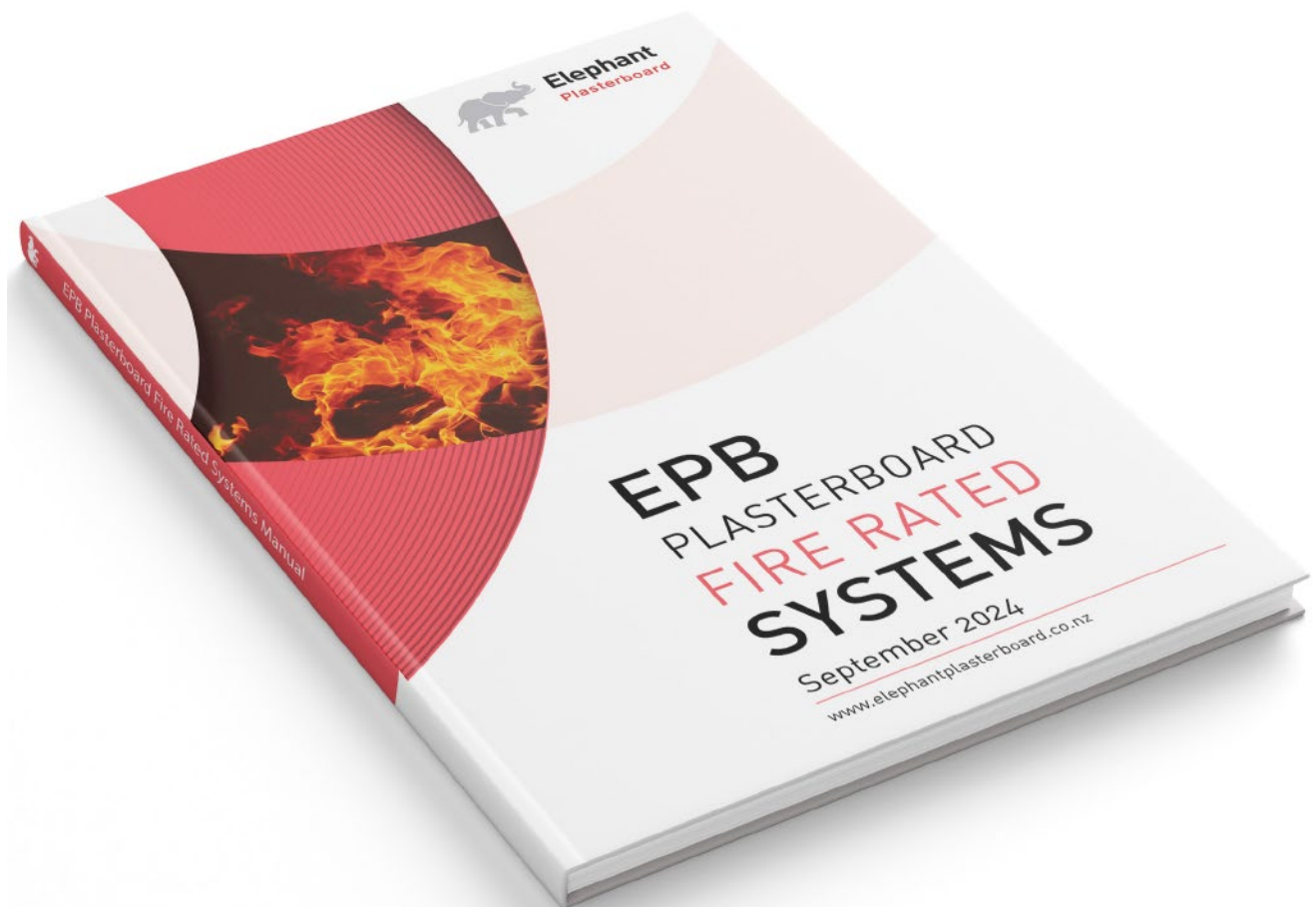

For Non-Acoustic Fire Rated system options, go to

EPB Plasterboard Fire Rated Systems Manual



Fire Rated Walls

System Number	Lining Suffix	FRR	Load Bearing Ability	Noise Control		Lining Requirements	Page
				STC	Rw		
Timber Frame Walls - Two Way FRR							
E2TL30	-S20	30/30/30	LB	37	36	1 x 10mm EPB Standard each side	Please refer EPB Fire Rated Systems Manual for these System Specification sheets
	-F20	30/30/30	LB	37	36	1 x 10mm EPB FireSmart each side	
	-S26	30/30/30	LB	37	36	1 x 13mm EPB Standard each side	
E4TL45	-S40	45/45/45	LB	42	41	2 x 10mm EPB Standard each side	
E4T60	-S40	-/60/60	NLB	42	41	2 x 10mm EPB Standard each side	
E2TL60	-F26	60/60/60	LB	38	37	1 x 13mm EPB FireSmart each side	
E4TL60	-F40	60/60/60	LB	42	41	2 x 10mm EPB FireSmart each side	
	-S46	60/60/60	LB	42	41	1 x 10mm EPB Standard and 1 x 13mm EPB Standard each side	
	-MS40	60/60/60	LB	42	41	1 x 10mm EPB Standard and 1 x 10mm EPB MultiSmart each side	
	-S52	60/60/60	LB	43	42	2 x 13mm EPB Standard each side	
E2TL75	-F32	75/75/75	LB	38	37	1 x 16mm EPB FireSmart each side	
E4T90	-FS52	-/90/90	NLB	43	42	1 x 13mm EPB FireSmart and 1 x 13mm EPB Standard each side	
	-FM46	-/90/90	NLB	43	42	1 x 13mm EPB FireSmart and 1 x 10mm EPB MultiSmart each side	
E4TL90	-F52	90/90/90	LB	45	44	2 x 13mm EPB FireSmart each side	
E4T105	-F52	-/105/105	NLB	44	43	2 x 13mm EPB FireSmart each side	
E4T120	-F58	-/120/120	NLB	46	45	1 x 16mm EPB FireSmart and 1 x 13mm EPB FireSmart each side	
E6TL120	-F78	120/120/120	LB	44	43	3 x 13mm EPB FireSmart each side	
EBV1TL30	-F10	30/30/30	LB	46	45	1 x 10mm EPB FireSmart one side Brick Veneer other side	
	-S13	30/30/30	LB	46	45	1 x 13mm EPB Standard one side Brick Veneer other side	
EBV1TL60	-F13	60/60/60	LB	46	45	1 x 13mm EPB FireSmart one side Brick Veneer other side	
Steel Frame Walls - Two Way FRR							
E2SL15	-S26	15/15/15	LB	35	34	1 x 13mm EPB Standard each side	
E2S30	-S26	-/30/30	NLB	35	34	1 x 13mm EPB Standard each side	
	-M20	-/30/30	NLB	36	35	1 x 10mm EPB MultiSmart each side	
E2SL30	-M26	30/30/30	LB	37	36	1 x 13mm EPB MultiSmart each side	
	-F32	30/30/30	LB	37	36	1 x 16mm EPB FireSmart each side	
E4SL30	-F40	30/30/30	LB	43	42	2 x 10mm EPB FireSmart each side	
	-S52	30/30/30	LB	43	42	2 x 13mm EPB Standard each side	
E2S60	-M26	-/60/60	NLB	37	36	1 x 13mm EPB MultiSmart each side (requires wall insulation)	



Fire Rated Walls

System Number	Lining Suffix	FRR	Load Bearing Ability	Noise Control		Lining Requirements	Page
				STC	Rw		
E4S60	-S52	-/60/60	NLB	45	44	2 x 13mm EPB Standard each side	
	-M40	-/60/60	NLB	45	44	2 x 10mm EPB MultiSmart each side	
E4SL60	-F52	60/60/60	LB	46	45	2 x 13mm EPB FireSmart each side	
E2S75	-F32	-/75/75	NLB	38	37	1 x 16mm EPB FireSmart each side	
E4S90	-M46	-/90/90	NLB	45	44	1 x 10mm EPB MultiSmart and 1 x 13mm EPB MultiSmart each side	
E4SL90	-F64	90/90/90	LB	47	46	2 x 16mm EPB FireSmart each side	
E4S120	-F58	-/120/120	NLB	46	45	1 x 16mm EPB FireSmart and 1 x 13mm FireSmart each side	
Double Steel Frame Wall with FireSmart Central Liner - Two Way FRR							
E2CSD60	-F26	-/60/60	NLB	44	43	1 x 13mm EPB FireSmart each side (requires wall insulation)	

Please refer EPB Fire Rated Systems Manual for these System Specification sheets

Fire Rated Universal Walls

System Number	Lining Suffix	FRR	Load Bearing Ability	Noise Control		Lining Requirements
				STC	Rw	
Universal Timber or Steel Frame Wall - One Way FRR						
E1UW15	-S13	15/15/15	LB	-	-	1 x 13mm EPB Standard one side
E1UW30	-F16a	30/30/30	LB	-	-	1 x 16mm EPB FireSmart one side
E2UW30	-F20	30/30/30	LB	-	-	2 x 10mm EPB FireSmart one side
E2UW45	-F26	45/45/45	LB	-	-	2 x 13mm EPB FireSmart one side
E2UW60	-F26a	60/60/60	LB	-	-	2 x 13mm EPB FireSmart one side
	-F29	60/60/60	LB	-	-	1 x 16mm EPB FireSmart and 1 x 13mm EPB FireSmart one side
E3UW90	-F39a	90/90/90	LB	-	-	3 x 13mm EPB FireSmart one side
	-F42	90/90/90	LB	-	-	1 x 16mm EPB FireSmart and 2 x 13mm EPB FireSmart one side
E3UW120	-F45a	120/120/120	LB	-	-	1 x 13mm EPB FireSmart and 2 x 16mm EPB FireSmart one side

Fire Rated Walls with simultaneous fire exposure on both sides

System Number	Lining Suffix	FRR	Load Bearing Ability	Noise Control		Lining Requirements
				STC	Rw	
Single Timber Frame Wall with Simultaneous Fire Exposure on Both sides - Two Way FRR						
E2TL30S	-F26	30/-/-	LB	38	37	1 x 13mm EPB FireSmart each side
E4TL60S	-F52	60/-/-	LB	46	45	2 x 13mm EPB FireSmart each side



Smoke Separation Walls

System Number	Lining Suffix	FRR	Load Bearing Ability	Noise Control		Lining Requirements	Page
				STC	Rw		
Smoke Separation - Timber or Steel Frame Wall - Two Way FRR							
E2sm10	-	10/10/10	LB	-	-	1 x Minimum 10mm EPB Plasterboard each side	

Fire Rated Floor/Ceilings

System Number	Lining Suffix	FRR	Load Bearing Ability	Noise Control			Lining Requirements
				STC	Rw	IIC	
Floor/Ceiling							
E1FC15	-S13	15/15/15	LB	38	37	31	1 x 13mm EPB Standard
E1FC30	-F13	30/30/30	LB	39	39	32	1 x 13mm EPB FireSmart
E2FC30	-S26	30/30/30	LB	39	38	32	2 x 13mm EPB Standard
E1FC45	-F13	45/45/45	LB	39	39	32	1 x 13mm EPB FireSmart
E1FC60	-F16	60/60/60	LB	39	38	32	1 x 16mm EPB FireSmart
E2FC60	-FS26	60/60/60	LB	40	39	33	1 x 13mm EPB FireSmart and 1 x 13mm EPB Standard
	-F26	60/60/60	LB	41	40	34	2 x 13mm EPB FireSmart
E2FC90	-F29	90/90/90	LB	41	40	34	1 x 16mm EPB FireSmart and 1 x 13mm EPB FireSmart
E3FC120	-F39	120/120/120	LB	43	42	35	3 x 13mm EPB FireSmart
Composite Joist Floor/Ceiling							
E1CJ30	-F13	30/30/30	LB	39	38	32	1 x 13mm EPB FireSmart
E2CJ30	-S26	30/30/30	LB	39	38	32	2 x 13mm EPB Standard
E1CJ45	-F13	45/45/45	LB	39	38	32	1 x 13mm EPB FireSmart
E1CJ60	-F16	60/60/60	LB	39	38	32	1 x 16mm EPB FireSmart
E2CJ60	-FS26	60/60/60	LB	40	39	33	1 x 13mm EPB FireSmart and 1 x 13mm EPB Standard
Steel Joist Floor/Ceiling							
E1SJ30	-F13	30/30/30	LB	35	34	31	1 x 13mm EPB FireSmart
E2SJ60	-F26	60/60/60	LB	39	38	32	2 x 13mm EPB FireSmart
Battened Floor/Ceiling							
E1BC30	-F13	30/30/30	LB	35	34	31	1 x 13mm EPB FireSmart
E1BC60	-F16	60/60/60	LB	39	38	32	1 x 16mm EPB FireSmart
Direct Fix Clip Floor/Ceiling							
E1DF45	-F13	45/45/45	LB	49	48	42	1 x 13mm EPB FireSmart
E1DF60	-F16	60/60/60	LB	49	48	43	1 x 16mm EPB FireSmart

Please refer EPB Fire Rated Systems Manual for these System Specification sheets



Fire Rated Floor/Ceilings

System Number	Lining Suffix	FRR	Load Bearing Ability	Noise Control			Lining Requirements	Page
				STC	Rw	IIC		
E2DF60	-FS26	60/60/60	LB	49	48	43	1 x 13mm EPB FireSmart and 1 x 13mm EPB Standard	
	-F26	60/60/60	LB	52	51	43	2 x 13mm EPB FireSmart	
E2DF90	-F32	90/90/90	NLB	54	53	43	2 x 16mm EPB FireSmart	
E3DF120	-F39	120/120/120	LB	54	53	43	3 x 13mm EPB FireSmart	
Suspended Grid Floor/Ceiling								
E2SC30	-S26	30/30/30	LB	50	49	42	2 x 13mm EPB Standard	
E1SC45	-F13	45/45/45	LB	48	47	42	1 x 13mm EPB FireSmart	
E1SC60	-F16	60/60/60	LB	48	47	43	1 x 16mm EPB FireSmart	
E1XC60	-F16	60/60/60	LB	48	47	43	1 x 16mm EPB FireSmart	
E2SC60	-FS26	60/60/60	LB	48	47	42	1 x 13mm EPB FireSmart and 1 x 13mm EPB Standard	
	-F26	60/60/60	LB	51	50	42	2 x 13mm EPB FireSmart	
E2SC90	-F32	90/90/90	LB	53	52	43	2 x 16mm EPB FireSmart	
E2XC90	-F29	90/90/90	LB	48	47	43	1 x 16mm EPB FireSmart and 1 x 13mm EPB FireSmart	

Please refer EPB Fire Rated Systems Manual for these System Specification sheets

Fire Rated Universal Ceilings

System Number	Lining Suffix	FRR	Load Bearing Ability	Noise Control			Lining Requirements
				STC	Rw	IIC	
Universal Ceiling - Timber or Steel Frame							
E1UC15	-F13	15/15/15	LB	-	-	-	1 x 13mm EPB FireSmart
E1UC30	-F16a	30/30/30	LB	-	-	-	1 x 16mm EPB FireSmart
E2UC60	-F26a	60/60/60	LB	-	-	-	2 x 13mm EPB FireSmart
	-F29	60/60/60	LB	-	-	-	1 x 16mm EPB FireSmart and 1 x 13mm EPB FireSmart
E3UC90	-F39a	90/90/90	LB	-	-	-	3 x 13mm EPB FireSmart
	-F42	90/90/90	LB	-	-	-	1 x 16mm EPB FireSmart and 2 x 13mm EPB FireSmart



Fire Rated Speciality Systems

System Number	Lining Suffix	FRR	Load Bearing Ability	Noise Control				Lining Requirements	Page
				STC					
				64mm Stud		102mm Stud			
				No Fill	Fill	No Fill	Fill		

Shaft Wall - Fire Rated from Shaft Side only

E1SWS60	-F13	-/60/60	NLB	39	45	42	46	1 x 13mm EPB FireSmart
E2SWS90	-F26	-/90/90	NLB	43	49	46	50	2 x 13mm EPB FireSmart
E2SWS120	-F29	-/120/120	NLB	44	50	46	51	1 x 16mm EPB FireSmart and 1 x 13mm EPB FireSmart

Shaft Wall - Fire Rated from Either Side

E1SWE30	-F13	-/30/30	NLB	39	45	42	46	1 x 13mm EPB FireSmart
E2SWE60	-F26	-/60/60	NLB	43	49	46	50	2 x 13mm EPB FireSmart
E2SWE90	-F29	-/90/90	NLB	44	50	46	51	1 x 16mm EPB FireSmart and 1 x 13mm EPB FireSmart
E3SWE120	-F42	-/120/120	NLB	46	51	48	52	1 x 16mm EPB FireSmart and 2 x 13mm EPB FireSmart

EPB Shaft Panel

EPB Shaft Panel								
-----------------	--	--	--	--	--	--	--	--

Fire Rated Columns & Beams

System Number	Lining Suffix	FRR	Load Bearing Ability	Noise Control		Lining Requirements
				STC	Rw	

Steel Column & Beam - Timber Strapped

E1CBT15	-S13	15/-/-	LB	-	-	1 x 13mm EPB Standard
E1CBT30	-F16	30/-/-	LB	-	-	1 x 16mm EPB FireSmart
E2CBT30	-F20	30/-/-	LB	-	-	2 x 10mm EPB FireSmart
E2CBT60	-F26	60/-/-	LB	-	-	2 x 13mm EPB FireSmart
E2CBT90	-F32	90/-/-	LB	-	-	2 x 16mm EPB FireSmart
E3CBT120	-F45	120/-/-	LB	-	-	1 x 13mm EPB FireSmart and 2 x 16mm EPB FireSmart

Steel Column & Beam - Steel Clip and Channel

E1CBS15	-S13	15/-/-	LB	-	-	1 x 13mm EPB Standard
E1CBS30	-F16	30/-/-	LB	-	-	1 x 16mm EPB FireSmart
E2CBS30	-F20	30/-/-	LB	-	-	2 x 10mm EPB FireSmart
E2CBS60	-F26	60/-/-	LB	-	-	2 x 13mm EPB FireSmart
E2CBS90	-F32	90/-/-	LB	-	-	2 x 16mm EPB FireSmart
E3CBS120	-F45	120/-/-	LB	-	-	1 x 13mm EPB FireSmart and 2 x 16mm EPB FireSmart

Please refer EPB Fire Rated Systems Manual for these System Specification sheets





For Noise Control Fire Rated system options, go to

EPB Plasterboard Noise Control Systems Manual

Full Intertency - Fire Rated Walls

System Number	Lining Suffix	FRR	Load Bearing Ability	Noise Control		Lining Requirements	Page
				STC	Rw		
Timber Double Frame Walls - Load Bearing							
E3TDLA30	-F30	30/30/30	LB	55	54	1 x 10mm EPB FireSmart one side 2 x 10mm EPB FireSmart other side	Please refer to the EPB Noise Control Systems Manual for these System Specification sheets
	-S39	30/30/30	LB	57	56	1 x 13mm EPB Standard one side 2 x 13mm EPB Standard other side	
	-M30	30/30/30	LB	58	57	1 x 10mm EPB MultiSmart one side 2 x 10mm EPB MultiSmart other side	
E4TDLA45	-S40	45/45/45	LB	58	57	2 x 10mm EPB Standard each side	
E2TDLA60	-M26	60/60/60	LB	55	54	1 x 13mm EPB MultiSmart each side	
E3TDLA60	-MS39	60/60/60	LB	58	57	1 x 13mm EPB MultiSmart one side 2 x 13mm EPB Standard other side	
	-M33	60/60/60	LB	59	58	1 x 13mm EPB MultiSmart one side 2 x 10mm EPB MultiSmart other side	
	-M39	60/60/60	LB	61	60	1 x 13mm EPB MultiSmart one side 2 x 13mm EPB MultiSmart other side	
E4TDLA60	-S46	60/60/60	LB	59	58	1 x 10mm EPB Standard and 1 x 13mm EPB Standard each side	
	-F40	60/60/60	LB	60	59	2 x 10mm EPB FireSmart each side	
	-S52	60/60/60	LB	61	60	2 x 13mm EPB Standard each side	
	-M40	60/60/60	LB	62	61	2 x 10mm EPB MultiSmart each side	
E2TDLA75	-F32	75/75/75	LB	56	55	1 x 16mm EPB FireSmart each side	
E4TDLA90	-F52	90/90/90	LB	64	63	2 x 13mm EPB FireSmart each side	
	-M52	90/90/90	LB	67	66	2 x 13mm EPB MultiSmart each side	
Timber Single Frame Walls with Resilient Mount - Load Bearing							
E3TMLA30	-S39	30/30/30	LB	55	54	Framing Side: 1 x 13mm EPB Standard Mount Side: 2 x 13mm EPB Standard	
	-M30	30/30/30	LB	56	55	Framing Side: 1 x 10mm EPB MultiSmart Mount Side: 2 x 10mm EPB MultiSmart	
E4TMLA30	-S40	30/30/30	LB	58	57	Framing Side: 2 x 10mm EPB FireSmart Mount Side: 2 x 10mm EPB FireSmart	
E4TMLA45	-S52	45/45/45	LB	61	60	Framing Side: 2 x 13mm EPB Standard Mount Side: 2 x 13mm EPB Standard	
E3TMLA60	-M39	60/60/60	LB	58	57	Framing Side: 1 x 13mm EPB MultiSmart Mount Side: 2 x 13mm EPB MultiSmart	
E4TMLA60	-M40	60/60/60	LB	62	61	Framing Side: 2 x 10mm EPB MultiSmart Mount Side: 2 x 10mm EPB MultiSmart	
E4TMLA90	-M52	90/90/90	LB	63	62	Framing Side: 2 x 13mm EPB MultiSmart Mount Side: 2 x 13mm EPB MultiSmart	
Timber Single Frame Walls with Resilient Rail - Load Bearing							
E4TRLA45	-S52	45/45/45	LB	55	54	Framing Side: 2 x 13mm EPB Standard Rail Side: 2 x 13mm EPB Standard	
E4TRLA60	-M40	60/60/60	LB	55	54	Framing Side: 2 x 10mm EPB MultiSmart Rail Side: 2 x 10mm EPB MultiSmart	
E4TRLA90	-F52	90/90/90	LB	56	55	Framing Side: 2 x 13mm EPB FireSmart Rail Side: 2 x 13mm EPB FireSmart	
	-M52	90/90/90	LB	57	56	Framing Side: 2 x 13mm EPB MultiSmart Rail Side: 2 x 13mm EPB MultiSmart	



Full Intertency - Fire Rated Walls

System Number	Lining Suffix	FRR	Load Bearing Ability	Noise Control		Lining Requirements	Page	
				STC	Rw			
Steel Double Frame Walls - Non Load Bearing								
E3SDA30	-S39	-/30/30	NLB	55	54	1 x 13mm EPB Standard one side 2 x 13mm EPB Standard other side	Please refer to the EPB Noise Control Systems Manual for these System Specification sheets	
	-M30	-/30/30	NLB	56	55	1 x 10mm EPB MultiSmart one side 2 x 10mm EPB MultiSmart other side		
E4SDA45	-F40	-/45/45	NLB	58	57	2 x 10mm EPB FireSmart each side		
E2SDA60	-M26	-/60/60	NLB	55	54	1 x 13mm EPB MultiSmart each side		
E3SDA60	-MS39	-/60/60	NLB	57	56	1 x 13mm EPB MultiSmart one side 2 x 13mm EPB Standard other side		
	-FM33	-/60/60	NLB	58	57	1 x 13mm EPB FireSmart one side 2 x 10mm EPB MultiSmart other side		
	-M33	-/60/60	NLB	58	57	1 x 13mm EPB MultiSmart one side 2 x 10mm EPB MultiSmart other side		
	-M39	-/60/60	NLB	61	60	1 x 13mm EPB MultiSmart one side 2 x 13mm EPB MultiSmart other side		
E4SDA60	-S52	-/60/60	NLB	61	60	2 x 13mm EPB Standard each side		
	-M40	-/60/60	NLB	61	60	2 x 10mm EPB MultiSmart each side		
E2SDA75	-F32	-/75/75	NLB	56	55	1 x 16mm EPB FireSmart each side		
E4SDA75	-MS52	-/75/75	NLB	63	62	1 x 13mm EPB Standard and 1x13mm EPB MultiSmart each side		
E4SDA90	-F52	-/90/90	NLB	62	61	2 x 13mm EPB FireSmart each side		
	-M46	-/90/90	NLB	63	62	1 x 10mm EPB MultiSmart and 1 x 13mm EPB MultiSmart each side		
	-M52	-/90/90	NLB	65	64	2 x 13mm EPB MultiSmart each side		
Steel Double Frame Walls - Load Bearing								
E2SDLA30	-M26	30/30/30	LB	55	54	1 x 13mm EPB MultiSmart each side		
	-F32	30/30/30	LB	56	55	1 x 16mm EPB FireSmart each side		
E3SDLA30	-MF33	30/30/30	LB	58	57	1 x 13mm EPB MultiSmart one side 2 x 10mm EPB FireSmart other side		
	-M39	30/30/30	LB	61	60	1 x 13mm EPB MultiSmart one side 2 x 13mm EPB MultiSmart other side		
E4SDLA30	-F40	30/30/30	LB	59	58	2 x 10mm EPB FireSmart each side		
E4SDLA45	-S52	45/45/45	LB	61	60	2 x 13mm EPB Standard each side		
	-M40	45/45/45	LB	61	60	2 x 10mm EPB MultiSmart each side		
E4SDLA60	-M52	60/60/60	LB	65	64	2 x 13mm EPB MultiSmart each side		
E4SDLA90	-F64	90/90/90	LB	66	65	1 x 16mm EPB FireSmart each side		



Full Intertency - Fire Rated Walls

System Number	Lining Suffix	FRR	Load Bearing Ability	Noise Control		Lining Requirements	Page	
				STC	Rw			
Steel Double Frame Walls with FireSmart Central Liner - Non Load Bearing								
E4CSDA60	-MS46	-/60/60	NLB	56	56	1 x 13mm EPB FireSmart and 1 x 10mm EPB Standard each side		
	-MS52	-/60/60	NLB	57	58	1 x 13mm EPB FireSmart And 1 x 13mm EPB Standard each side		
Steel Frame Walls with Resilient Mount - Non Load Bearing								
E3SMA30	-M30	-/30/30	NLB	55	54	Frame Side: 1 x 10mm EPB MultiSmart Mount Side: 2 x 10mm EPB MultiSmart	Please refer to the EPB Noise Control Systems Manual for these System Specification sheets	
E4SMA30	-F40	-/30/30	NLB	56	55	Frame Side: 2 x 10mm EPB FireSmart Mount Side: 2 x 10mm EPB FireSmart		
E3SMA60	-MS39	-/60/60	NLB	56	55	Frame Side: 1 x 13mm EPB MultiSmart Mount Side: 2 x 13mm EPB Standard		
	-M39	-/60/60	NLB	57	56	Frame Side: 1 x 13mm EPB MultiSmart Mount Side: 2 x 13mm EPB MultiSmart		
E4SMA60	-S52	-/60/60	NLB	58	57	Frame Side: 2 x 13mm EPB Standard Mount Side: 2 x 13mm EPB Standard		
	-M40	-/60/60	NLB	59	58	Frame Side: 2 x 10mm EPB MultiSmart Mount Side: 2 x 10mm EPB MultiSmart		
E4SMA90	-M46	-/90/90	NLB	60	59	Frame Side: 1 x 13mm EPB MultiSmart and 1 x 10mm EPB MultiSmart Mount Side: 1 x 13mm EPB MultiSmart and 1 x 10mm EPB MultiSmart		
	-M52	-/90/90	NLB	62	61	Frame Side: 2 x 13mm EPB MultiSmart Mount Side: 2 x 13mm EPB MultiSmart		
Steel Frame Walls with Resilient Rail - Non Load Bearing								
E4SRA60	-S52	-/60/60	NLB	55	54	Frame Side: 2 x 13mm EPB Standard Rail Side: 2 x 13mm EPB Standard		
	-M40	-/60/60	NLB	56	55	Frame Side: 2 x 10mm EPB MultiSmart Rail Side: 2 x 10mm EPB MultiSmart		
E4SRA90	-M46	-/90/90	NLB	57	56	Frame Side: 1 x 13mm EPB MultiSmart and 1 x 10mm EPB MultiSmart Rail Side: 1 x 13mm EPB MultiSmart and 1 x 10mm EPB MultiSmart		
	-F52	-/90/90	NLB	57	56	Frame Side: 2 x 13mm EPB FireSmart Rail Side: 2 x 13mm EPB FireSmart		
	-M52	-/90/90	NLB	59	58	Frame Side: 2 x 13mm EPB MultiSmart Rail Side: 2 x 13mm EPB MultiSmart		
Quiet Steel Frame Walls - Non Load Bearing								
E4SQA30	-F40	-/30/30	NLB	55	54	2 x 10mm EPB FireSmart each side		
E4SQA45	-S46	-/45/45	NLB	56	55	1x 10mm EPB Standard and 1 x 13mm Standard each side		
E3SQA60	-M33	-/60/60	NLB	55	54	1 x 13mm EPB MultiSmart one side 2 x 10mm EPB MultiSmart other side		
	-M36	-/60/60	NLB	55	54	1 x 13mm EPB MultiSmart one side 1 x 10mm EPB MultiSmart and 1 x 13mm EPB MultiSmart other side		
	-M39	-/60/60	NLB	57	56	1 x 13mm EPB MultiSmart one side 2 x 13mm EPB MultiSmart other side		
E4SQA60	-S52	-/60/60	NLB	57	56	2 x 13mm EPB Standard each side		
	-M40	-/60/60	NLB	57	56	2 x 10mm EPB MultiSmart each side		
E4SQA75	-MS52	-/75/75	NLB	59	58	1 x13mm EPB MultiSmart and 1x13mm EPB Standard each side		
E4SQA90	-M46	-/90/90	NLB	59	58	1 x 10mm EPB MultiSmart and 1 x 13mm EPB MultiSmart each side		
	-M52	-/90/90	NLB	61	60	2 x 13mm EPB MultiSmart each side		



Full Intertency - Fire Rated Walls

System Number	Lining Suffix	FRR	Load Bearing Ability	Noise Control		Lining Requirements	Page
				STC	Rw		
Staggered Steel Stud Walls - Non Load Bearing							
E3SSA30	-S39	-/30/30	NLB	55	54	1 x 13mm EPB Standard on One side 2 x 13mm EPB Standard on Other side	
E4SSA45	-F40	-/45/45	NLB	56	55	2 x 10mm EPB FireSmart each side	
E3SSA60	-MS39	-/60/60	NLB	56	55	1 x 13mm EPB MultiSmart one side 2 x 13mm EPB Standard other side	
	-M39	-/60/60	NLB	57	56	1 x 13mm EPB MultiSmart one side 2 x 13mm EPB MultiSmart other side	
E4SSA60	-S52	-/60/60	NLB	59	58	2 x 13mm EPB Standard each side	
E4SSA90	-M46	-/90/90	NLB	59	58	1 x 10mm EPB MultiSmart and 1 x 13mm EPB MultiSmart each side	
	-M52	-/90/90	NLB	62	61	2 x 13mm EPB MultiSmart each side	

Please refer to the EPB Noise Control Systems Manual for these System Specification sheets



Full Intertency - Fire Rated Floor/Ceilings

System Number	Lining Suffix	FRR	Load Bearing Ability	Noise Control			Lining Requirements	Page
				STC	Rw	IIC		
Direct Fix Clip - Floating Floor/Ceiling - Timber Joist								
EFJ2DFA60	-FS26	60/60/60	LB	66	65	57-76	1 x 13mm EPB FireSmart and 1 x 13mm EPB Standard	
	-F26	60/60/60	LB	67	66	57-76	2 x 13mm EPB FireSmart	
	-M26	60/60/60	LB	68	67	57-77	2 x 13mm EPB MultiSmart	
EFP2DFA60	-FS26	60/60/60	LB	63	62	55-72	1 x 13mm EPB FireSmart and 1 x 13mm EPB Standard	
	-F26	60/60/60	LB	64	63	55-72	2 x 13mm EPB FireSmart	
	-M26	60/60/60	LB	65	64	56-72	2 x 13mm EPB MultiSmart	
Direct Fix Clip - Floating Floor/Ceiling - Steel Joist								
EFJ2DFsA45	-F26	45/45/45	LB	66	65	56-76	2 x 13mm EPB FireSmart	
	-M26	45/45/45	LB	67	66	56-76	2 x 13mm EPB MultiSmart	
EFP2DFsA45	-F26	45/45/45	LB	63	62	55-72	2 x 13mm EPB FireSmart	
	-M26	45/45/45	LB	64	63	55-72	2 x 13mm EPB MultiSmart	
EFJ2DFsA60	-F29	60/60/60	LB	67	66	56-76	1 x 13mm EPB FireSmart and 1 x 16mm EPB FireSmart	
EFP2DFsA60	-F29	60/60/60	LB	64	63	56-72	1 x 13mm EPB FireSmart and 1 x 16mm EPB FireSmart	
Direct Fix Clip - Floor/Ceiling - Timber Joist								
E2DFA60	-FS26	60/60/60	LB	56	55	46-73	1 x 13mm EPB FireSmart and 1 x 13mm EPB Standard	
	-F26	60/60/60	LB	57	56	46-73	2 x 13mm EPB FireSmart	
	-M26	60/60/60	LB	58	57	46-73	2 x 13mm EPB MultiSmart	
E2DFA90	-FM29	90/90/90	LB	57	56	47-73	1 x 16mm EPB FireSmart and 1 x 13mm EPB MultiSmart	
	-F32	90/90/90	LB	58	57	47-73	2 x 16mm EPB FireSmart	
Suspended Grid Floor/Ceiling - Timber Joist								
E2SCA60	-MS26	60/60/60	LB	56	55	40-72	1 x 13mm EPB MultiSmart and 1 x 13mm EPB Standard	
	-F26	60/60/60	LB	56	55	40-72	2 x 13mm EPB FireSmart	
	-M26	60/60/60	LB	56	55	40-72	2 x 13 EPB MultiSmart	
E2SCA75	-F29	75/75/75	LB	57	56	47-72	1 x 16mm EPB FireSmart and 1 x 13mm EPB FireSmart	
E2SCA90	-F32	90/90/90	LB	57	56	40-73	2 x 16mm EPB FireSmart	
Direct Fix Clip - Floor/Ceiling - Steel Joist								
E2DFsA45	-F26	45/45/45	LB	56	55	47-74	2 x 13mm EPB FireSmart	
	-M26	45/45/45	LB	57	56	47-74	2 x 13mm EPB MultiSmart	
E2DFsA60	-FM29	60/60/60	LB	57	56	47-75	1 x 16mm EPB FireSmart and 1 x 13mm EPB MultiSmart	
	-F32	60/60/60	LB	57	56	47-75	2 x 16mm EPB FireSmart	

Please refer to the EPB Noise Control Systems Manual for these System Specification sheets



Sub Intertenancy - Walls

System Number	Lining Suffix	FRR	Load Bearing Ability	Noise Control		Lining Requirements	Page
				STC	Rw		
Single Timber Frame Walls - Load Bearing							
E2TLa30	-S20	30/30/30	LB	39	38	1 x 10mm EPB Standard each side	Please refer to the EPB Noise Control Systems Manual for these System Specification sheets
	-S26	30/30/30	LB	40	39	1 x 13mm EPB Standard each side	
	-M20	30/30/30	LB	41	40	1 x 10mm EPB MultiSmart each side	
E3TLa30	-S30	30/30/30	LB	42	41	1 x 10mm EPB Standard one side 2 x 10mm EPB Standard other side	
	-S39	30/30/30	LB	43	42	1 x 13mm EPB Standard one side 2 x 13mm EPB Standard other side	
	-M30	30/30/30	LB	44	43	1 x 10mm EPB MultiSmart on One side 2 x 10mm EPB MultiSmart on Other side	
E4TLa45	-S40	45/45/45	LB	44	43	2 x 10mm EPB Standard each side	
E2TLa60	-M26	60/60/60	LB	42	41	1 x 13mm EPB MultiSmart each side	
E3TLa60	-MS39	60/60/60	LB	45	44	1 x 13mm EPB MultiSmart one side 2 x 13mm EPB Standard other side	
	-M33	60/60/60	LB	45	44	1 x 13mm EPB MultiSmart one side 2 x 10mm EPB MultiSmart other side	
	-M39	60/60/60	LB	46	45	1 x 13mm EPB MultiSmart one side 2 x 13mm EPB MultiSmart other side	
E4TLa60	-S46	60/60/60	LB	45	44	1 x 10mm EPB Standard and 1 x 13mm EPB Standard each side	
	-S52	60/60/60	LB	46	45	2 x 13mm EPB Standard each side	
	-M40	60/60/60	LB	46	45	2 x 10mm EPB MultiSmart each side	
E4TLa90	-M52	90/90/90	LB	48	47	2 x 13mm EPB MultiSmart each side	
Double Timber Frame Walls - Load Bearing							
E2TDLa30	-S20	30/30/30	LB	50	49	1 x 10mm EPB Standard each side	
	-S26	30/30/30	LB	52	51	1 x 13mm EPB Standard each side	
	-M20	30/30/30	LB	52	51	1 x 10mm EPB MultiSmart each side	
Single Timber Frame Walls with Resilient Mount- Load Bearing							
E3TMLa30	-S30	30/30/30	LB	52	51	Frame Side: 1 x 10mm EPB Standard Mount Side: 2 x 10mm EPB Standard	
Single Timber Frame Walls with Resilient Rail- Load Bearing							
E3TRLa30	-S30	30/30/30	LB	47	46	Frame Side: 1 x 10mm EPB Standard Rail Side: 2 x 10mm EPB Standard	
	-S39	30/30/30	LB	50	49	Frame Side: 1 x 13mm EPB Standard Rail Side: 2 x 13mm EPB Standard	
	-M30	30/30/30	LB	51	50	Frame Side: 1 x 10mm EPB MultiSmart Rail Side: 2 x 10mm EPB MultiSmart	
E3TRLa60	-MS39	60/60/60	LB	52	50	Frame Side: 1 x 13mm EPB MultiSmart Rail Side: 2 x 13mm EPB Standard	
	-M39	60/60/60	LB	52	51	Frame Side: 1 x 13mm EPB MultiSmart Rail Side: 2 x 13mm EPB MultiSmart	



Sub Intertenancy - Walls

System Number	Lining Suffix	FRR	Load Bearing Ability	Noise Control		Lining Requirements	Page
				STC	Rw		
Single Steel Frame Walls - Non Load Bearing							
E2Sa15	-S20	-/15/15	NLB	40	39	1 x 10mm EPB Standard each side	Please refer to the EPB Noise Control Systems Manual for these System Specification sheets
E2Sa30	-S26	-/30/30	NLB	41	40	1 x 13mm EPB Standard each side	
	-M20	-/30/30	NLB	42	41	1 x 10mm EPB MultiSmart each side	
E3Sa30	-S33	-/30/30	NLB	43	42	1 x 13mm EPB Standard one side 2 x 10mm EPB Standard other side	
	-S39	-/30/30	NLB	44	42	1 x 13mm EPB Standard one side 2 x 13mm EPB Standard other side	
	-M30	-/30/30	NLB	44	43	1 x 10mm EPB MultiSmart one side 2 x 10mm EPB MultiSmart other side	
E4Sa45	-S40	-/45/45	NLB	45	44	2 x 10mm EPB Standard each side	
E2Sa60	-M26	-/60/60	NLB	43	42	1 x 13mm EPB MultiSmart each side	
E3Sa60	-MS39	-/60/60	NLB	44	43	1 x 13mm EPB MultiSmart one side 2 x 13mm EPB Standard other side	
	-M39	-/60/60	NLB	45	44	1 x 13mm EPB MultiSmart one side 2 x 13mm EPB MultiSmart other side	
E4Sa60	-S46	-/60/60	NLB	46	45	1 x 10mm EPB Standard and 1 x 13mm EPB Standard each side	
	-S52	-/60/60	NLB	48	47	2 x 13mm EPB Standard each side	
	-M40	-/60/60	NLB	48	47	2 x 10mm EPB MultiSmart each side	
E4Sa90	-M46	-/90/90	NLB	50	49	1 x 10mm EPB MultiSmart and 1 x 13mm EPB MultiSmart each side	
E4Sa105	-M52	-/105/105	NLB	52	51	2 x 13mm EPB MultiSmart each side	
Single Steel Frame Walls - Load Bearing							
E2SLa30	-M26	30/30/30	LB	43	42	1 x 13mm EPB MultiSmart each side	
E3SLa30	-M39	30/30/30	LB	45	44	1 x 13mm EPB MultiSmart one side 2 x 13mm EPB MultiSmart other side	
E4SLa30	-S40	30/30/30	LB	45	44	2 x 10mm EPB Standard each side	
E4SLa45	-S52	45/45/45	LB	48	47	2 x 13mm EPB Standard each side	
	-M40	45/45/45	LB	48	47	2 x 10mm EPB MultiSmart each side	
E4SLa60	-M52	60/60/60	LB	52	51	2 x 13mm EPB MultiSmart each side	
E4SLa90	-F64	90/90/90	LB	53	52	2 x 16mm EPB FireSmart each side	
Double Steel Frame Walls - Non Load Bearing							
E2SDa30	-S26	-/30/30	NLB	52	51	1 x 13mm EPB Standard each side	
	-M20	-/30/30	NLB	52	51	1 x 10mm EPB MultiSmart each side	



Sub Intertenancy - Walls

System Number	Lining Suffix	FRR	Load Bearing Ability	Noise Control		Lining Requirements	Page	
				STC	Rw			
Steel Frame Walls with Resilient Rail- Non Load Bearing								
E3SRa30	-S39	-/30/30	NLB	51	50	Frame Side: 1 x 13mm EPB Standard Rail Side: 2 x 13mm EPB Standard	Please refer to the EPB Noise Control Systems Manual for these System Specification sheets	
	-M30	-/30/30	NLB	51	50	Frame Side: 1 x 10mm EPB MultiSmart Rail Side: 2 x 10mm EPB MultiSmart		
E3SRa60	-MS39	-/60/60	NLB	52	51	Frame Side: 1 x 13mm EPB MultiSmart Rail Side: 2 x 13mm EPB Standard		
	-M39	-/60/60	NLB	53	52	Frame Side: 1 x 13mm EPB MultiSmart Rail Side: 2 x 13mm EPB MultiSmart		
Quiet Steel Frame Walls - Non Load Bearing								
E2SQa30	-S26	-/30/30	NLB	47	46	1 x 13mm EPB Standard each side		
	-M20	-/30/30	NLB	48	47	1 x 10mm EPB MultiSmart each side		
E3SQa30	-S39	-/30/30	NLB	53	52	1 x 13mm EPB Standard one side 2 x 13mm EPB Standard other side		
	-M30	-/30/30	NLB	53	52	1 x 10mm EPB MultiSmart one side 2 x 10mm EPB MultiSmart other side		
E3SQa45	-MS33	-/45/45	NLB	52	51	1 x 13mm EPB MultiSmart one side 2 x 10mm EPB Standard other side		
E2SQa60	-M26	-/60/60	NLB	50	49	1 x 13mm EPB MultiSmart each side		
Staggered Steel Stud Walls - Non Load Bearing								
E2SSa30	-S26	-/30/30	NLB	50	49	1 x 13mm EPB Standard each side		
	-M20	-/30/30	NLB	49	48	1 x 10mm EPB MultiSmart each side		
E2SSa60	-M26	-/60/60	NLB	52	51	1 x 13mm EPB MultiSmart each side		
	-F32	-/60/60	NLB	54	53	1 x 16mm EPB FireSmart each side		

Sub Intertenancy - Floor/Ceilings

System Number	Lining Suffix	FRR	Load Bearing Ability	Noise Control			Lining Requirements
				STC	Rw	IIC	
Direct Fix Clip - Floor/Ceiling							
E1DFa15	-S13	15/15/15	LB	48	47	43-69	1 x 13mm EPB Standard
E2DFa30	-S26	30/30/30	LB	53	52	43-69	2 x 13mm EPB Standard
E1DFa45	-M13	45/45/45	LB	52	51	43-69	1 x 13mm EPB MultiSmart
E1DFa60	-F16	60/60/60	LB	52	51	43-69	1 x 16mm EPB FireSmart
Suspended Grid Floor/Ceiling							
E1SCa15	-S13	15/15/15	LB	48	47	39-62	1 x 13mm EPB Standard
E2SCa30	-S26	30/30/30	LB	53	52	42-67	2 x 13mm EPB Standard
E1SCa45	-M13	45/45/45	LB	51	50	43-69	1 x 13mm EPB MultiSmart
E1SCa60	-F16	60/60/60	LB	52	51	43-69	1 x 16mm EPB FireSmart



INTRODUCTION

This manual provides details for construction of two way fire and acoustic walls and floor/ceilings with EPB Plasterboard & Fibre Cement to provide fire protection as required by the NZBC clause C1 to C6 "Protection From Fire".

Elephant Plasterboard (NZ) Limited has many different combinations of two way fire and acoustic plasterboard & fibre cement wall and floor/ceiling fire rated systems. It is the responsibility of the specifier to accommodate the required performance of the building they are considering. The specifier should take into consideration both external and internal noise control and fire rating for occupants intended use. Special consideration must be taken in the construction process.

All construction details that have been provided in this manual are generic only and it is important that expert advice is sought to determine suitability in each individual project.

Limitations and Conditions of Use

- EPB Plasterboard is intended for normal conditions of dry internal use.
- EPB Plasterboard must not be used for bracing applications in or around baths and shower areas.
- EPB Plasterboard must not be exposed to liquid water or be installed in situations where extended exposures to humidity above 90% Relative Humidity are to be expected. Bathrooms, kitchens and laundries should have adequate ventilation or heating to avoid condensation build-up.
- A suitable surface finish (e.g. Vinyl wallpaper or gloss and semi-gloss alkyd paints) must be applied to EPB Plasterboard in all areas where liquid water or high humidity can be expected.
- EPB Plasterboard must not be installed over a vapour barrier.
- EPB Plasterboard must not be applied directly to masonry, concrete or solid plaster, unless timber strapping or steel furring channels are used.
- EPB Plasterboard must not be exposed to temperatures of 52°C or greater for prolonged periods.
- EPB Plasterboard may not be used as an external lining.

New Zealand Building Code (NZBC) Compliance

EPB Plasterboard is manufactured to AS/NZS 2588 and has been specifically formulated to meet New Zealand Building Code requirements. EPB Plasterboard has been marketed internationally since 1975 and the product has established an excellent history of performance for its use in buildings throughout New Zealand and the Asia/Pacific region. EPB Plasterboard meets the durability requirements of the NZBC and is subject to use, installation and maintenance in accordance with the instructions outlined in this manual. The Manufacturing plant is International Standard ISO 9001 and ISO 14001 registered.

- **NZBC Clause B1 Structure**
Framing material specifications used with EPB Plasterboard Systems must be in accordance with the performance requirements of NZBC Clause B1. Timber framed walls and floors must be installed and meet the requirements of NZS 3604.
- **NZBC Clause B2 Durability**
EPB Plasterboard Fire, Noise Control & Bracing Systems have a serviceable life of not less than 50 years and so is in accordance to NZBC B2.3.1.
- **NZBC Clause C1-C6 Protection from Fire**
EPB Plasterboard Fire & Noise Control Systems can meet the requirements of providing passive fire protection as per NZBC Clause C1-C6.
- **NZBC Clause E3 Internal Moisture**
EPB Plasterboard Wet Area Systems can meet the requirements of NZBC Acceptable Solution E3/AS1.
- **NZBC Clause F2 Hazardous Building Materials**
EPB Plasterboard Systems meet this requirement of NZBC Clause F2 and will not present a health hazard to people.
- **NZBC Clause G6 - Airborne & Impact Sound**
EPB Plasterboard Noise Control Systems entitled 'Full Intertency' (STC 55 or greater) systems meet the requirements of NZBC Clause G6.



INTRODUCTION

Fire Resistance Ratings (FRR)

To prevent fire spread or structural collapse, the Acceptable Solutions require building elements to have fire resistance ratings (FRRs). The level of FRR required depends on the risk group of the building.

FRR components

An FRR comprises three numbers: these give time values in minutes for structural adequacy, integrity and insulation. Eg. --/60/60 (a/b/c). Primary and secondary elements required to have an FRR will, depending on their function, need to satisfy one or more of these three criteria as follows:

- a) **Structural Adequacy:** usually provided by primary elements within a fire cell. These include building elements which are part of the structure, and those providing support to other elements with an FRR within the same or adjacent fire cells. Examples are: columns, beams, floors and walls (which may also be fire separations).
- b) **Integrity:** usually provided by secondary elements. Examples are fire separations, which are internal partitions and floors, areas of external walls not permitted to be an unprotected area, and some areas of roofs when close to another building or crossed by an exit way. Primary elements forming an integral part of a fire separation are also rated for integrity.
- c) **Insulation:** applies to fire separations and is required where the transmission of heat through the element may endanger occupants on the other side or cause fire to spread to other fire cells or adjacent buildings. For example, insulation is necessary for fire separations between sleeping spaces, where protecting a safe path or through external walls.

EPB Plasterboard Fire Rated Systems have numerous system combinations as outlined in this manual. All EPB Plasterboard Fire Rated systems have been tested or internally assessed or have opinions provided by independent accredited quality assurance organisations like "The Building Research Association of New Zealand (BRANZ)".

Internal Lining Surface Finish Properties

EPB Plasterboard has been tested at BRANZ in accordance with ISO 5660 Reaction to fire tests (Heat release, smoke production and mass loss rate) Part 1: Heat release rate (cone calorimeter method); and ISO 5660 Reaction to fire tests (Heat release, smoke production and mass loss rate) Part 2: Smoke production rate (dynamic measurement).

A Group Number Classification of **1-S** was achieved in Fire test FH 5695-TT for all EPB Plasterboard paper faced sheet linings. This classification only applies to EPB Plasterboard paper faced sheet linings without paint or wallpaper finish. Contact the surface finish suppliers for group number information for their products.

'Group Number 1-S' is the highest performance expectation under 'Part 4. Control of Internal Fire and Smoke Spread' clause C/AS2 to C/AS7 of the NZBC. It means an EPB Plasterboard paper faced sheet lining can be specified for use in any risk group application.

Control Of External Fire Spread

External spread of fire applies where:

- The building height is greater than 10m and upper floors have sleeping uses or are different property, refer to clause C3.5 of the NZBC;
- The building is located within 1m of a relevant boundary, refer to clause C3.7 of the NZBC.

Refer to Table 5.1 of Section 5.4 of C/AS1 and Table 5.5 of Section 5.8.1 of C/AS2 for the information about various risk groups to identify the external fire spread safety requirement applicable to the exterior surface finishes.

For the situations where 'no requirement' is listed in the compliance documents, James Hardie cladding systems installed over a flexible underlay as per the information published in the James Hardie Technical Specification Literature complies. See page 13 for list of relevant James Hardie Technical Literature.

For the other situations, James Hardie claddings in conjunction with RAB™ Board fixed into timber frame with R2.2 fibreglass insulation/James Hardie Mineral Insulation complies.

In addition, for buildings over 10m in height, the external wall cavity must be blocked off either at each floor level or at heights no more than 3.5m to prevent fire spread within the cavity. Refer to latest James Hardie Fire & Acoustic Design Manual - Figure 7: Intertency Fire Separation, for the horizontal joint detail to create a fire separation in conjunction with James Hardie claddings.

For construction details of James Hardie claddings with RAB™ Board, Ask James Hardie on 0800 808 868.



EPB Plasterboard & Fibre Cement Fire Rated Walls

EPB Plasterboard & Fibre Cement Fire Rated Systems have been tested on timber & steel frame walls as Load Bearing (LB)

Timber Frame

Stud heights, stud spacings, load and framing dimensions for Load Bearing (LB) Timber framed walls are determined by the NZBC, and NZS 3604. Heights greater than what is defined in NZS 3604 will need specific design by a structural engineer.

- Internal Walls**
 Minimum framing of 90 x 45mm shall be used with a maximum stud spacing of 600mm. Nogs to be spaced at 800mm maximum. Minimum framing depth as per fire and acoustic system selected or the structural requirements whichever is greater. All sheet edges must be supported by framing timber. Timber framing treatment to comply with the minimum requirements of NZS 3602. When framing at 140 x 45mm the maximum stud spacing 600mm.
- External Walls**
 Minimum framing & maximum stud spacings according to the table provided on figure EFC-001. Nogs to be spaced at 800mm maximum. Minimum framing depth as per fire and acoustic system selected or the structural requirements whichever is greater. All sheet edges must be supported by framing timber. Timber framing treatment to comply with the minimum requirements of NZS 3602.
- Floors**
 Floor joists of minimum 45mm width to be used. Strutting of floor joist as per NZS 3604 is required. Bottom plate fixing in timber floors must penetrate through floor into joists or solid blocking.

Steel Frame

Steel framing for fire rated walls must be in accordance with NASH standard for residential and low rise buildings and AS/NZ 1170 standards. Steel frame must comply with the durability requirements of NZBC. Steel sections shall be galvanized/zinc coated and have a base metal thickness (BMT) 0.55mm minimum for non-load bearing walls and 0.75mm minimum for load bearing walls and 1.6mm maximum. A minimum of 89mm deep x 36mm wide steel stud framing to be used in external walls. Maximum stud spacing at 400mm centres. Nogs to be spaced at 800mm centres maximum. All sheet edges must be formed over and supported by framing.

All steel framing must be used according to their manufacturer's instructions. Steel framing properties vary considerably depending upon the grade of steel used. It is the designer's responsibility to ensure the type of framing selected is fit for purpose and suitable to carry design loads.

Thermal Fire Batten

Fire battens are used on all FRR steel stud systems and must be used between James Hardie cladding and steel framing face. For steel framing in interior/exterior applications the NZBC also requires additional external insulation to achieve adequate thermal resistance. Refer to James Hardie Fire and Acoustic Design Manual for correct assembly and installation of Thermal Fire Battens.

These insulated battens are assembled on site by cutting a 100mm wide strip from 9mm thick EasyLap™ Panel and adhering a 10mm thick x 100mm wide XPS (extruded polystyrene) on its face. All fire battens are fixed horizontally and vertically to all steel members. All battens must be neatly cut and tightly fitted covering all steel members. All thermal fire battens must be fitted with the polystyrene to the exterior face. The batten is tacked to the steel framing as shown in the following detail.

Structural Steel Members in Fire Rated Walls

Structural steel members such as columns or beams are sometimes located inside the cavities of two way fire rated wall or floor/ceiling systems. The FRR of the two way fire rated system applies across the entire element, from exposed side to the unexposed side. The temperature inside the cavity can rise above the critical temperature level for structural steel members resulting in premature buckling. Therefore by containing a structural steel member within a two way fire system, it cannot be automatically assumed that the structural steel member will maintain its structural integrity of the two way fire system within which it is contained. Hence, either reference should be made to the column and beam section of the EPB Fire Rated System Manual for further information on protection of structural steel members.

Cavity Insulation

In order to achieve the stated fire ratings in this manual all cavities must be filled with an insulation material regardless if its an internal or external wall.

- Glass wool Insulation**
 Any brand of R2.2 glass wool insulation with a weight between 12-18kg/m³ may be used. This insulation can be substituted with a higher R-value fibreglass insulation to achieve higher insulation requirements.
- James Hardie Mineral Insulation**
 In a fire rated system where a mineral insulation is specified, only James Hardie Mineral Insulation must be used. James Hardie Mineral Insulation cannot be substituted with any other insulation material. Refer to the James Hardie Mineral Insulation Technical Supplement for correct application.

Also refer to clause H1 of the NZBC for further information on R-value Requirement

Fire Retardant Flexible Underlay

All external walls must have a fire retardant flexible underlay or a rigid air barrier installed beneath the cladding.

In a FRR system, any flexible underlay that complies with Table 23 of E2/AS1 and has a Flammability Index not exceeding 5, when tested to AS 1530.2 may be used. Installation of a flexible underlay must be in accordance with the manufacturer's recommendations and their installation instructions.

Rigid Air Barrier

James Hardie RAB™ Board can be used to achieve the published fire ratings stated in this manual. Refer to James Hardie Home RAB™ Pre-Cladding & RAB™ Board Installation Manual for information regarding its installation.

For EH wind zone or Specific Engineering Design (SED) projects where the design wind pressures are between 1.5kPa (ULS) and 2.5kPa (ULS), James Hardie RAB™ Board must be used.

In addition, for buildings over 10m in height, the external wall cavity must be blocked off either at each floor level or at heights no more than 3.5m to prevent fire spread within the cavity. Refer to latest James Hardie Fire & Acoustic Design Manual - Figure 7: Intertency Fire Separation, for the horizontal joint detail to create a fire separation in conjunction with James Hardie claddings.

Flexible underlay is not required when using James Hardie RAB™ Board.

For construction details of James Hardie claddings with RAB™ Board, Ask James Hardie on 0800 808 868.

EPB QuickBrace System

The bracing systems specified in the EPB QuickBrace Systems Manual can easily be combined with the EPB Fire Rated Systems by adhering to the details outlined for the relevant Bracing system type and relevant Fire Rated System requirements.

For Single layered Fire Rated systems, use the QuickBrace fastening pattern and the required screw length of the Fire Rated Systems.

For Double layered Fire Rated systems, the bracing sheet can be either:

- The Inner sheet fixed directly to the framing. Use the QuickBrace fastening pattern and the required screw length of the Fire Rated System. The inner layer can be left unstopped; or
- The Outer sheet. Use the QuickBrace fastening pattern and the required screw length of the Fire Rated System.

EPB Plasterboard & Fibre Cement Fire Rated Floor/Ceiling

EPB Plasterboard & Fibre Cement Fire Rated Systems have been tested on Load bearing floor/ceiling systems. Refer to this manual for fixings and layer combinations. Ceiling linings must be mechanically fixed. Glue may not be substituted for mechanical fixing if used in a passive fire system. Screw lengths, spacings and type as defined by this manual must be used.

- **Timber Joists**
Floor/ceiling system as defined in NZS 3604 for floor loadings (2.0 kPa or 3.0 kPa) may be used. Consult NZS 3604 latest edition for floor joist spans. Floor joists must have a minimum of 190mm depth x 45mm width and a maximum spacing of 600mm centres. Consult the appropriate supplier's technical information for design strength and serviceability.
- **Steel Joists**
Steel floor joists shall be a minimum depth of 190mm C-section with 45mm flanges and a steel gauge of 1.6mm minimum. Joists to be spaced at no more than 600mm centres.
- **Flooring**
Floor/Ceiling system must have a floor that is at least 20mm thick particle board complying with AS/NZS 1860 Part 1: 2017 or minimum 17mm thick structural ply complying with AS/NZS 2269 Part 0: 2012 fixed to the floor joists as per manufacturer's installation instructions.
- **Floating Floor**
The floating floor systems must be either 19mm James Hardie Tongue & Groove Secura™ Interior Floor or 20mm Tongue & Groove Particle Board complying to AS/NZS 1860.

Post Fire Stability

The fire rated walls built close to boundary are required to achieve post fire stability in either direction in accordance with the NZBC verification method B1/VM1, paragraph 2.2.4. The bottom plate of these walls can be fixed in accordance with the post fire stability details published in this design manual on page 85, using Pryda Brace anchor brackets on either side of the stud.

For steel framing, post fire stability must be as per SED.



Product & Component Substitution

When a product specified in a system as per this manual is substituted, the performance of the system will be compromised. Therefore the materials specified in the system must not be substituted. Elephant Plasterboard (NZ) Limited does not take any liability if substitution of components are implemented in any EPB Plasterboard Systems without consultation.

EPB Plasterboard Substitution Options

The table below indicates which products can substitute the original EPB Plasterboard type specified.

✓ indicates that the FRR performance will be maintained

X indicates that the FRR performance will be lower and so therefore the substitution is not allowed

Original EPB Plasterboard specified	EPB Plasterboard Substitution Options - FRR performance								
	Standard		FireSmart			MultiSmart		AquaSmart	
	10mm	13mm	10mm	13mm	16mm	10mm	13mm	10mm	13mm
10mm Standard	✓	✓	✓	✓	✓	✓	✓	✓	✓
13mm Standard	X	✓	X	✓	✓	✓	✓	✓	✓
10mm FireSmart	X	✓	✓	✓	✓	✓	✓	✓	✓
13mm FireSmart	X	X	X	✓	✓	X	✓	X	✓
16mm FireSmart	X	X	X	X	✓	X	X	X	X
10mm MultiSmart	X	X	X	✓	✓	✓	✓	✓	✓
13mm MultiSmart	X	X	X	✓	✓	X	✓	X	✓



James Hardie Cladding Options & Technical Literature

The James Hardie product layout and installation must be in accordance with the relevant James Hardie product literature for the cladding selected. Refer to the table below for limitations and relevant James Hardie product technical literature.

Linea™ Weatherboard			
	Timber Cavity Batten	Direct Fix	
	<ul style="list-style-type: none"> - Install over Timber Cavity Battens - RAB™ Board required for buildings over 10m or EH wind zone - Refer to Linea™ Weatherboard Cavity Fix Technical Specification 	<ul style="list-style-type: none"> - Refer to Linea™ Weatherboard Direct Fix Technical Specification 	
Linea™ Oblique™ Weatherboard			
Horizontal fixing	<ul style="list-style-type: none"> - Install over Timber Cavity Battens - RAB™ Board required for buildings over 10m or EH wind zone - Refer to Linea™ Oblique™ Weatherboard Horizontal Installation Technical Specification 		
Vertical fixing	<ul style="list-style-type: none"> - Install over James Hardie Horizontal Timber Cavity Battens - RAB™ Board required for buildings over 10m or EH wind zone - Refer to Linea™ Oblique™ Weatherboard Vertical Installation Technical Specification & Linea™ Oblique™ Vertical Installation to JH 40mm structural horizontal cavity batten Technical Specification 		
Stria™ Cladding			
Horizontal fixing	<ul style="list-style-type: none"> - Install over Timber Cavity Battens - RAB™ Board required for buildings over 10m or EH wind zone - Refer to Stria™ Cladding Timber Cavity Batten Horizontal Technical Specification 		
Vertical fixing	<ul style="list-style-type: none"> - Install over James Hardie Horizontal Timber Cavity Battens - RAB™ Board required for buildings over 10m or EH wind zone - Refer to Stria™ Cladding Vertical Technical Specification 		
Horizontal fixing CLD™ Structural Batten	<ul style="list-style-type: none"> - RAB™ Board must be used to achieve fire ratings - Install over CLD™ Structural Cavity Battens - Refer to Stria™ Cladding CLD™ Structural Cavity Batten Technical Specification 		
Axon™ Panel & EasyLap™ Panel			
	Timber Cavity Batten	Direct Fix	CLD™ Structural Batten
	<ul style="list-style-type: none"> - RAB™ Board required for buildings over 10m or EH wind zone - Refer to Axon™ Panel & EasyLap™ Panel Timber Cavity Batten Technical Specification 	<ul style="list-style-type: none"> - Refer to Axon™ Panel EasyLap™ Panel Direct Fixed & Fixed to CLD™ Structural Cavity Batten Technical Specification 	<ul style="list-style-type: none"> - RAB™ Board must be used to achieve fire ratings - Refer to Axon™ Panel EasyLap™ Panel Direct Fixed & Fixed to CLD™ Structural Cavity Batten Technical Specification
Hardie™ Plank Weatherboards		Hardie™ Flex Sheet	
<ul style="list-style-type: none"> - Install over Timber Cavity Battens - Refer to Hardie™ Plank Weatherboard Technical Specification 		<ul style="list-style-type: none"> - Install over Timber Cavity Battens - Refer to Hardie™ Flex Sheet Technical Specification 	
ExoTec™ Facade Panel		Villaboard™ Lining	RAB™ Board
<ul style="list-style-type: none"> - RAB™ Board must be used to achieve fire ratings - Install over Top Hat system - Refer to ExoTec™ Facade Panel Top Hat Rainscreen Technical Specification 		<ul style="list-style-type: none"> - Refer Villaboard™ Lining Installation Manual - For internal applications only 	<ul style="list-style-type: none"> - Refer HomeRAB™ Pre-Cladding & RAB™ Board Installation Manual - Cannot be used as a weathertight cladding.



Nomenclature:

EPB Specification Reference - Fire Wall with Fibre Cement

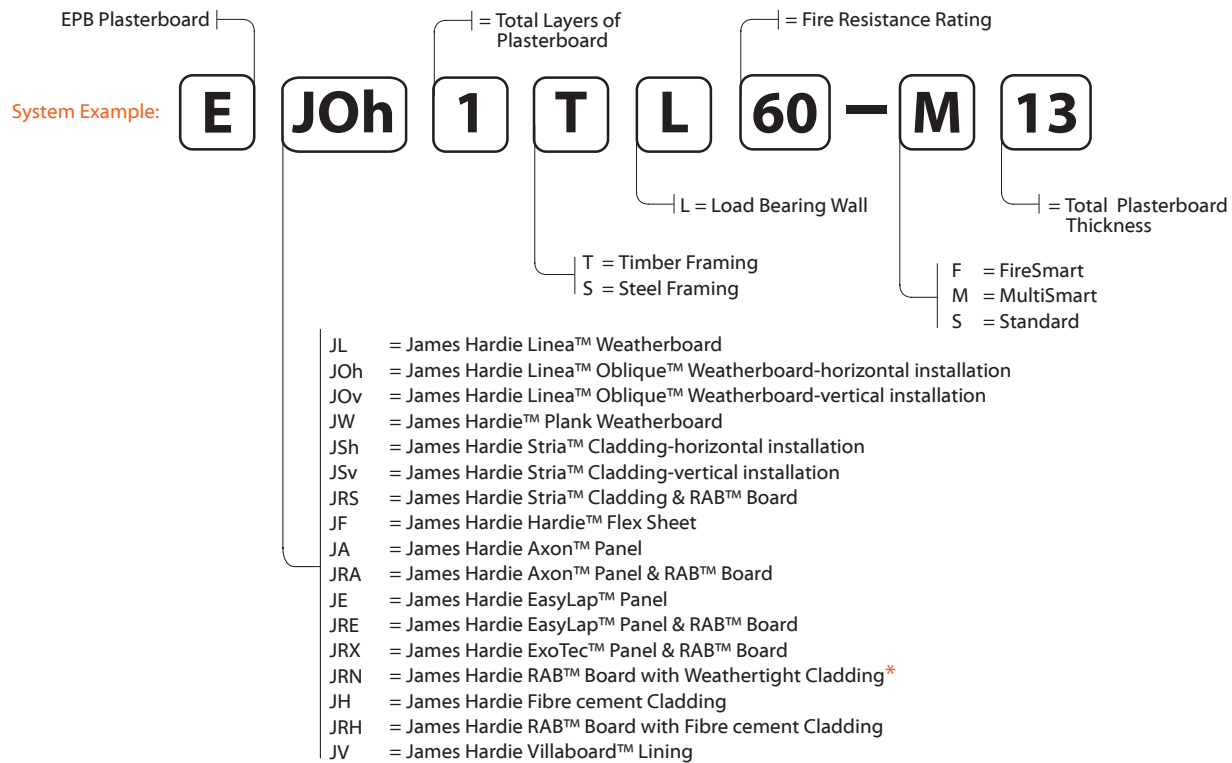

***Note1 :** It is also important to consider that the fire properties of the external cladding is in accordance with NZBC C/VM1 or C/AS documents. Refer to Table 5.1 of Section 5.4 of C/AS1 and Table 5.5 of Section 5.8.1 of C/AS2 for the information about various risk groups to identify the external fire spread safety requirement applicable to the exterior surface finishes.

EPB Specification Reference - Floor/Ceiling with Fibre Cement

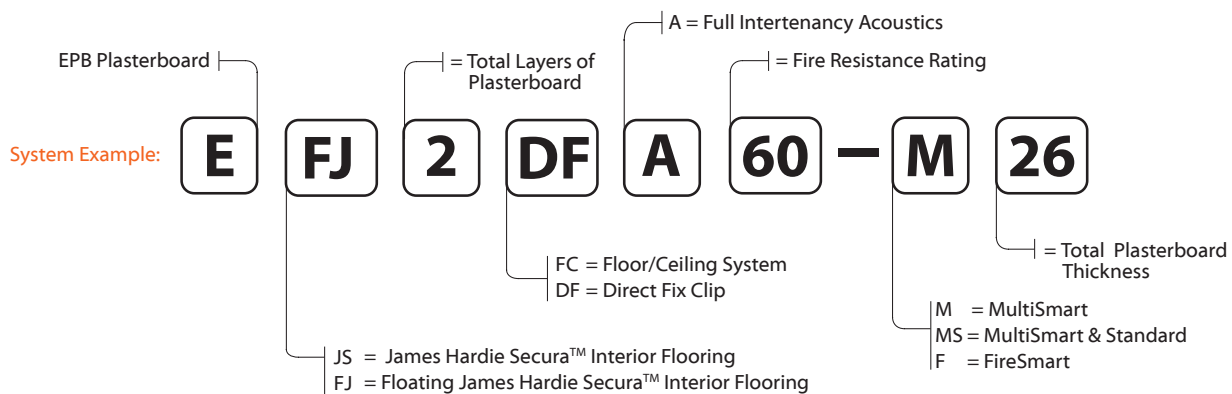



External Timber Frame Walls

EJL1TL30

EPB & James Hardie Linea™ Weatherboard

Two Way FRR

External Wall - Timber Frame

Load Bearing

System Number	Lining Suffix	FRR	Insulation	Noise Control STC	Lining Requirement
EJL1TL30	-F10	30/30/30	R2.2 glass wool	46	1 x 10mm EPB FireSmart on Internal side James Hardie Linea™ Weatherboard to External side

Framing, Wall Height, Load and Framing Dimension

Timber framing to comply with relevant sections and clauses of NZBC B1: Structure and NZBC B2: Durability. Timber framing must be in accordance with NZS3604 stud tables for load bearing or non-load bearing partitions. Furthermore;

- Minimum framing dimension is 90 x 45mm.
- Nogs must be in place at a maximum of 800mm centres.
- Maximum stud spacing's are 600mm centres.
- The fire rated walls built close to boundary are also required to achieve post fire stability in either direction in accordance with the NZBC verification method B1/VM1, paragraph 2.2.4

Refer to latest James Hardie Fire & Acoustic Design Manual figures and tables for further detail.

Underlay

For the type of allowable underlay refer to table below.

	EH Wind Zone	Other Wind Zone
Buildings <10m	RAB	Flexible Underlay
Buildings >10m	RAB	RAB

Fire Retardant Flexible Underlay

Install any Fire Retardant Flexible Underlay beneath the claddings, that complies with Table 23 of E2/AS1 and has a flammability index not exceeding 5.

RAB™ Board

One layer of James Hardie RAB™ Board fixed to entire framing.

6mm RAB™ Board : Use 40 x 2.8mm fibre cement nail at 200mm centres

9mm RAB™ Board : Use 50 x 2.8mm fibre cement nail at 200mm centres

Fixing to be 12mm from sheet edges

Reference to be made to the James Hardie Home RAB™ Pre-Cladding & RAB™ Board Installation Manual.

Cavity Batten

When Cavity Batten is required, use a nominal 20mm Timber Cavity Batten. Refer to Linea™ Weatherboard Cavity Fix Technical Specification for installation instructions. When Cladding can be directly fixed without a cavity batten then a fire retardant flexible underlay must be used (if allowable). Refer to Linea™ Weatherboard Direct Fix Technical Specification.

Linea™ Weatherboard Cladding

James Hardie Linea™ Weatherboard cladding to external side of the timber framing. Consider the nail length required depending on the type of fixing i.e. Cavity fixing or Direct fixing. Refer to both Linea™ Weatherboard Cavity Fix Technical Specification and Linea™ Weatherboard Direct Fix Technical Specification AND the James Hardie Fire & Acoustic Design Manual for information regarding fixing and finishing.

Wall Insulation

Insulation must be installed between studs and nogs. Use 90mm thick R2.2 glass wool insulation.

EPB Plasterboard Lining

NB: The installer must look for the Product Identification Code on the face paper to ensure the correct board type is installed. Refer to the Face Paper Product Identification Code table on this page.

One layer of 10mm EPB FireSmart lining to internal side of framing. Vertical fixing only permitted. Use full height sheets where possible when fixing vertical. All sheet joints must be fixed over solid timber framing. Sheets shall be touch fitted.

Fixing of EPB Plasterboard Internal Linings

Fasteners

41mm x 6g High Thread Drywall Screws

Fastener Centres

Fix at 300mm centres around sheet perimeter and up all intermediate studs. Place fasteners 50mm from sheet corners along the top and bottom plates. On end studs place additional fasteners 50-60mm vertically and no close than 10mm from plate to stud connections.

Place fasteners no closer than 12mm from the sheet edges and 18mm from sheet ends. Place fasteners at 200mm centres where sheet end butt joints occur.

Jointing and Finishing of EPB Plasterboard

All fastener heads stopped and all sheet joints reinforced with paper jointing tape and stopped. All in accordance with Elephant Plasterboard Installation Guide.

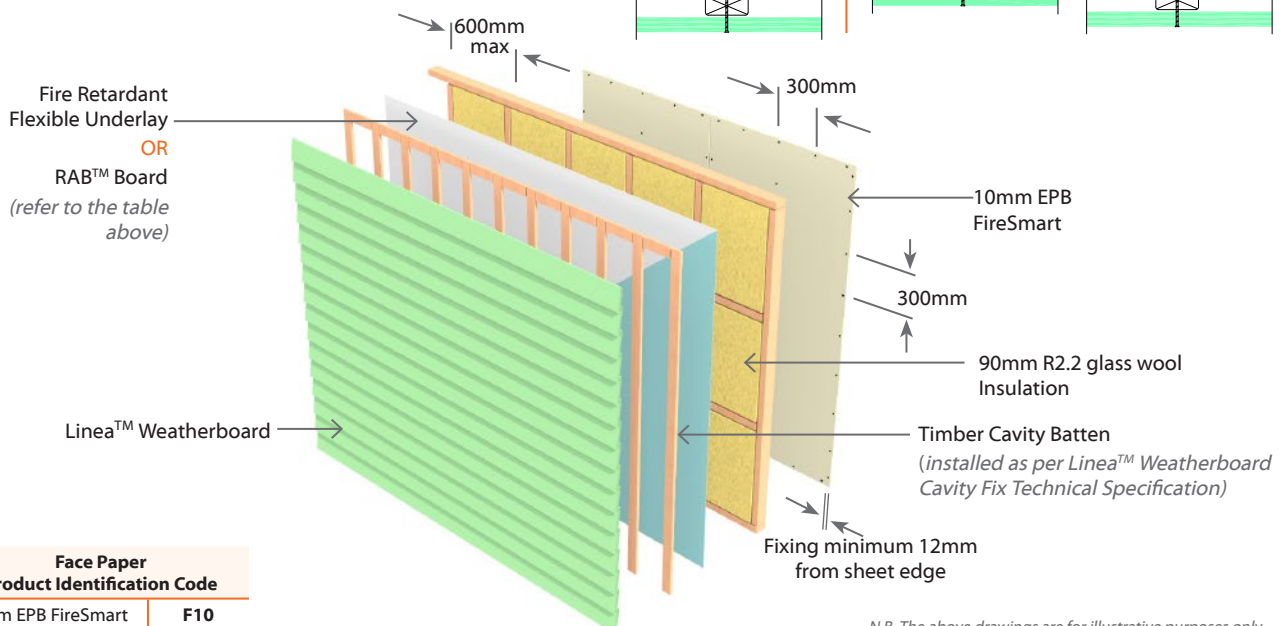
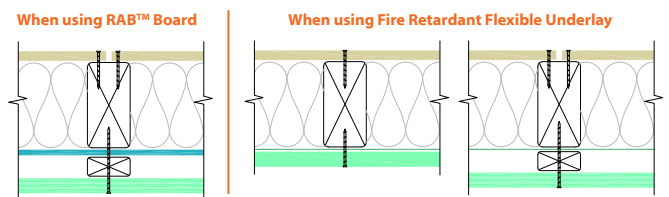

N.B. The above drawings are for illustrative purposes only.



EJL1TL60 EPB & James Hardie Linea™ Weatherboard Two Way FRR

External Wall - Timber Frame Load Bearing

System Number	Lining Suffix	FRR	Insulation	Noise Control STC	Lining Requirement
EJL1TL60	-M13	60/60/60	R2.2 glass wool	47	1 x 13mm EPB MultiSmart on Internal side James Hardie Linea™ Weatherboard to Other side

Framing, Wall Height, Load and Framing Dimension

Timber framing to comply with relevant sections and clauses of NZBC B1: Structure and NZBC B2: Durability. Timber framing must be in accordance with NZS3604 stud tables for load bearing or non-load bearing partitions. Furthermore;

- Minimum framing dimension is 90 x 45mm.
- Nogs must be in place at a maximum of 800mm centres.
- Maximum stud spacing's are 600mm centres.
- The fire rated walls built close to boundary are also required to achieve post fire stability in either direction in accordance with the NZBC verification method B1/VM1, paragraph 2.2.4

Refer to latest James Hardie Fire & Acoustic Design Manual figures and tables for further detail.

Underlay

For the type of allowable underlay refer to table below.

	EH Wind Zone	Other Wind Zone
Buildings <10m	RAB	Flexible Underlay
Buildings >10m	RAB	RAB

Fire Retardant Flexible Underlay

Install any Fire Retardant Flexible Underlay beneath the claddings, that complies with Table 23 of E2/AS1 and has a flammability index not exceeding 5.

RAB™ Board

One layer of James Hardie RAB™ Board fixed to entire framing.
 6mm RAB™ Board : Use 40 x 2.8mm fibre cement nail at 200mm centres
 9mm RAB™ Board : Use 50 x 2.8mm fibre cement nail at 200mm centres
 Fixing to be 12mm from sheet edges
 Reference to be made to the James Hardie Home RAB™ Pre-Cladding & RAB™ Board Installation Manual.

Cavity Batten

When Cavity Batten is required, use a nominal 20mm Timber Cavity Batten. Refer to Linea™ Weatherboard Cavity Fix Technical Specification for installation instructions. When Cladding can be directly fixed without a cavity batten then a fire retardant flexible underlay must be used (if allowable). Refer to Linea™ Weatherboard Direct Fix Technical Specification.

Linea™ Weatherboard Cladding

James Hardie Linea™ Weatherboard cladding to external side of the timber framing. Consider the nail length required depending on the type of fixing i.e. Cavity fixing or Direct fixing. Refer to both Linea™ Weatherboard Cavity Fix Technical Specification and Linea™ Weatherboard Direct Fix Technical Specification AND the James Hardie Fire & Acoustic Design Manual for information regarding fixing and finishing.

Wall Insulation

Insulation must be installed between studs and nogs. Use 90mm thick R2.2 glass wool insulation.

EPB Plasterboard Lining

NB: The installer must look for the Product Identification Code on the face paper to ensure the correct board type is installed. Refer to the Face Paper Product Identification Code table on this page.

One layer of 13mm EPB MultiSmart lining to internal side of framing. Vertical fixing only permitted. Use full height sheets where possible when fixing vertical. All sheet joints must be fixed over solid timber framing. Sheets shall be touch fitted.

Fixing of EPB Plasterboard Internal Linings

Fasteners

41mm x 6g High Thread Drywall Screws

Fastener Centres

Fix at 300mm centres around sheet perimeter and up all intermediate studs. Place fasteners 50mm from sheet corners along the top and bottom plates. On end studs place additional fasteners 50-60mm vertically and no close than 10mm from plate to stud connections.

Place fasteners no closer than 12mm from the sheet edges and 18mm from sheet ends. Place fasteners at 200mm centres where sheet end butt joints occur.

Jointing and Finishing of EPB Plasterboard

All fastener heads stopped and all sheet joints reinforced with paper jointing tape and stopped. All in accordance with Elephant Plasterboard Installation Guide.

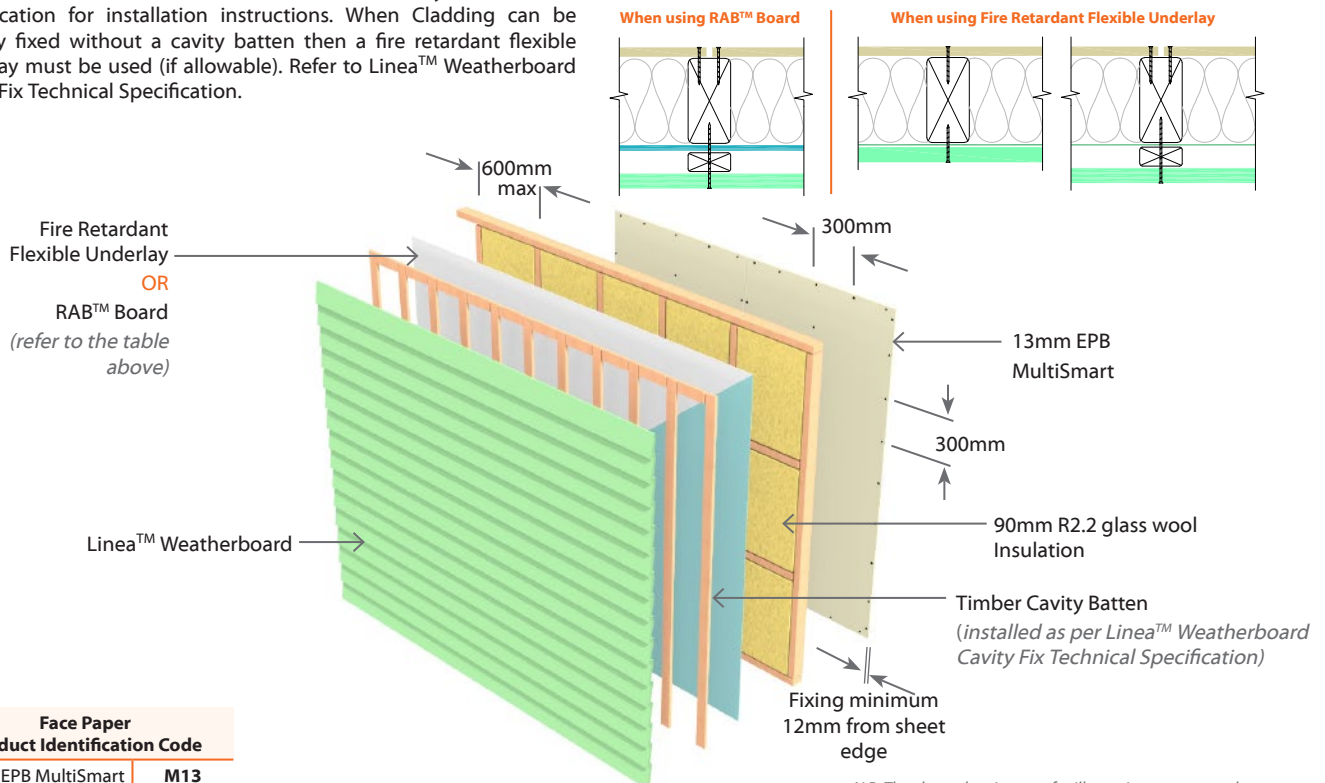

Face Paper Product Identification Code	
13mm EPB MultiSmart	M13

N.B. The above drawings are for illustrative purposes only.



EJOh1TL30

EPB & James Hardie Linea™ Oblique™ Weatherboard - Horizontal

Two Way FRR

External Wall - Timber Frame

Load Bearing

System Number	Lining Suffix	FRR	Insulation	Noise Control STC	Lining Requirement
EJOh1TL30	-F10	30/30/30	R2.2 glass wool	46	1 x 10mm EPB FireSmart on Internal side James Hardie Linea™ Oblique™ Weatherboard horizontal to External side

Framing, Wall Height, Load and Framing Dimension

Timber framing to comply with relevant sections and clauses of NZBC B1: Structure and NZBC B2: Durability. Timber framing must be in accordance with NZS3604 stud tables for load bearing or non-load bearing partitions. Furthermore;

- Minimum framing dimension is 90 x 45mm.
- Nogs must be in place at a maximum of 800mm centres.
- Maximum stud spacing's are 600mm centres.
- The fire rated walls built close to boundary are also required to achieve post fire stability in either direction in accordance with the NZBC verification method B1/VM1, paragraph 2.2.4

Refer to latest James Hardie Fire & Acoustic Design Manual figures and tables for further detail.

Underlay

For the type of allowable underlay refer to table below.

	EH Wind Zone	Other Wind Zone
Buildings <10m	RAB	Flexible Underlay
Buildings >10m	RAB	RAB

Fire Retardant Flexible Underlay

Install any Fire Retardant Flexible Underlay beneath the claddings, that complies with Table 23 of E2/AS1 and has a flammability index not exceeding 5.

RAB™ Board

One layer of James Hardie RAB™ Board fixed to entire framing.

6mm RAB™ Board : Use 40 x 2.8mm fibre cement nail at 200mm centres

9mm RAB™ Board : Use 50 x 2.8mm fibre cement nail at 200mm centres

Fixing to be 12mm from sheet edges

Reference to be made to the James Hardie Home RAB™ Pre-Cladding & RAB™ Board Installation Manual.

Cavity Batten

Use a nominal 20mm Timber Cavity Batten. Refer to Linea™ Oblique™ Horizontal Installation Technical Specification for installation instructions.

Linea™ Oblique™ Weatherboard Cladding - Horizontal

James Hardie Linea™ Oblique™ Weatherboard cladding fixed horizontally to external side of the timber framing. Refer to both Linea™ Oblique™ Horizontal Installation Technical Specification AND the James Hardie Fire & Acoustic Design Manual for information regarding fixing and finishing.

Wall Insulation

Insulation must be installed between studs and nogs. Use 90mm thick R2.2 glass wool insulation.

EPB Plasterboard Lining

NB: The installer must look for the Product Identification Code on the face paper to ensure the correct board type is installed. Refer to the Face Paper Product Identification Code table on this page.

One layer of 10mm EPB FireSmart lining to internal side of framing. Vertical fixing only permitted. Use full height sheets where possible when fixing vertical. All sheet joints must be fixed over solid timber framing. Sheets shall be touch fitted.

Fixing of EPB Plasterboard Internal Linings

Fasteners

41mm x 6g High Thread Drywall Screws

Fastener Centres

Fix at 300mm centres around sheet perimeter and up all intermediate studs. Place fasteners 50mm from sheet corners along the top and bottom plates. On end studs place additional fasteners 50-60mm vertically and no close than 10mm from plate to stud connections.

Place fasteners no closer than 12mm from the sheet edges and 18mm from sheet ends. Place fasteners at 200mm centres where sheet end butt joints occur.

Jointing and Finishing of EPB Plasterboard

All fastener heads stopped and all sheet joints reinforced with paper jointing tape and stopped. All in accordance with Elephant Plasterboard Installation Guide.

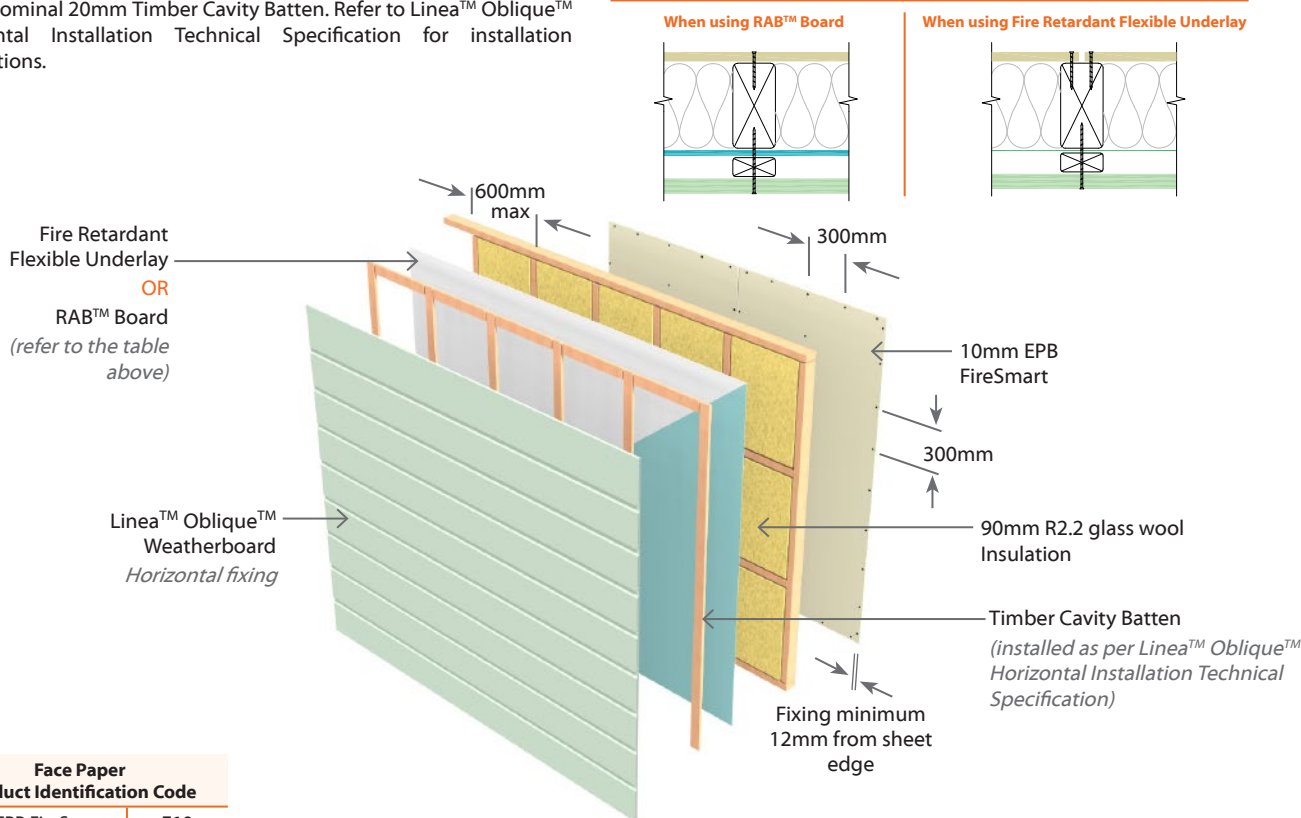

Face Paper Product Identification Code
10mm EPB FireSmart F10

N.B. The above drawings are for illustrative purposes only.



EJOv1TL30 EPB & James Hardie Linea™ Oblique™ Weatherboard - Vertical Two Way FRR

External Wall - Timber Frame Load Bearing

System Number	Lining Suffix	FRR	Insulation	Noise Control STC	Lining Requirement
EJOv1TL30	-F10	30/30/30	R2.2 glass wool	46	1 x 10mm EPB FireSmart on Internal side James Hardie Linea™ Oblique™ Weatherboard vertical to External side

Framing, Wall Height, Load and Framing Dimension

Timber framing to comply with relevant sections and clauses of NZBC B1: Structure and NZBC B2: Durability. Timber framing must be in accordance with NZS3604 stud tables for load bearing or non-load bearing partitions. Furthermore;

- Minimum framing dimension is 90 x 45mm.
 - Nogs must be in place at a maximum of 800mm centres.
 - Maximum stud spacing's are 600mm centres.
 - The fire rated walls built close to boundary are also required to achieve post fire stability in either direction in accordance with the NZBC verification method B1/VM1, paragraph 2.2.4
- Refer to latest James Hardie Fire & Acoustic Design Manual figures and tables for further detail.

Underlay

For the type of allowable underlay refer to table below.

	EH Wind Zone	Other Wind Zone
Buildings <10m	RAB	Flexible Underlay
Buildings >10m	RAB	RAB

Fire Retardant Flexible Underlay

Install any Fire Retardant Flexible Underlay beneath the claddings, that complies with Table 23 of E2/AS1 and has a flammability index not exceeding 5.

RAB™ Board

One layer of James Hardie RAB™ Board fixed to entire framing.
 6mm RAB™ Board : Use 40 x 2.8mm fibre cement nail at 200mm centres
 9mm RAB™ Board : Use 50 x 2.8mm fibre cement nail at 200mm centres
 Fixing to be 12mm from sheet edges
 Reference to be made to the James Hardie Home RAB™ Pre-Cladding & RAB™ Board Installation Manual.

Cavity Batten

Use a 20mm James Hardie Horizontal Timber Cavity Batten. Refer to Linea™ Oblique™ Vertical Installation Technical Specification for installation instructions.

Linea™ Oblique™ Weatherboard Cladding - Vertical

James Hardie Linea™ Oblique™ Weatherboard cladding fixed vertically to external side of the timber framing. Refer to both Linea™ Oblique™ Vertical Installation Technical Specification AND the James Hardie Fire & Acoustic Design Manual for information regarding fixing and finishing.

Wall Insulation

Insulation must be installed between studs and nogs. Use 90mm thick R2.2 glass wool insulation.

EPB Plasterboard Lining

One layer of 10mm EPB FireSmart lining to internal side of framing. Vertical fixing only permitted. Use full height sheets where possible when fixing vertical. All sheet joints must be fixed over solid timber framing. Sheets shall be touch fitted.

Fixing of EPB Plasterboard Internal Linings

Fasteners

41mm x 6g High Thread Drywall Screws

Fastener Centres

Fix at 300mm centres around sheet perimeter and up all intermediate studs. Place fasteners 50mm from sheet corners along the top and bottom plates. On end studs place additional fasteners 50-60mm vertically and no close than 10mm from plate to stud connections. Place fasteners no closer than 12mm from the sheet edges and 18mm from sheet ends. Place fasteners at 200mm centres where sheet end butt joints occur.

Jointing and Finishing of EPB Plasterboard

All fastener heads stopped and all sheet joints reinforced with paper jointing tape and stopped. All in accordance with Elephant Plasterboard Installation Guide.

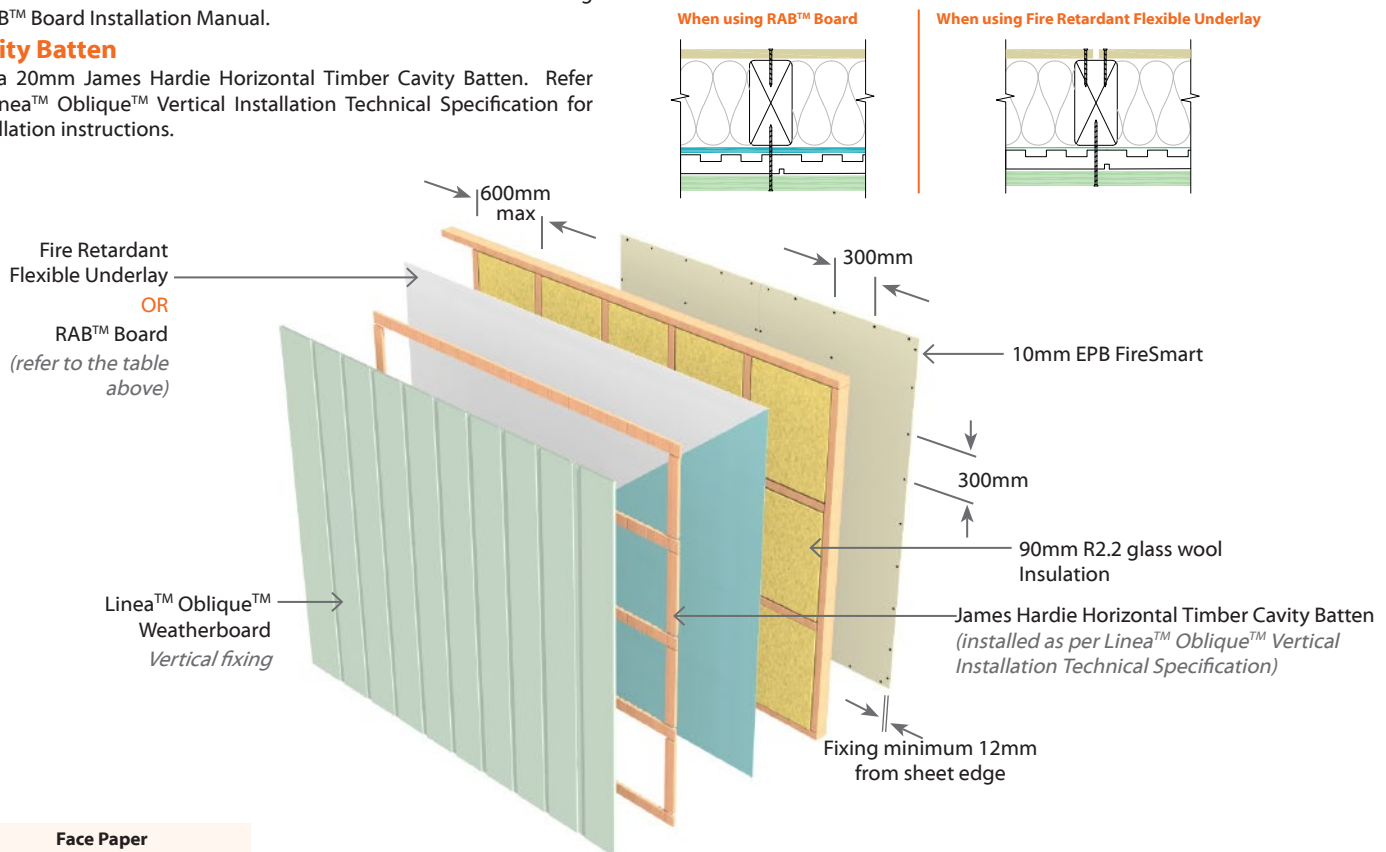

Face Paper	Product Identification Code
10mm EPB FireSmart	F10

N.B. The above drawings are for illustrative purposes only.

EJOh1TL60

EPB & James Hardie Linea™ Oblique™ Weatherboard - Horizontal

Two Way FRR

External Wall - Timber Frame

Load Bearing

System Number	Lining Suffix	FRR	Insulation	Noise Control STC	Lining Requirement
EJOh1TL60	-M13	60/60/60	R2.2 glass wool	47	1 x 13mm EPB MultiSmart on Internal side James Hardie Linea™ Oblique™ Weatherboard horizontal to External side

Framing, Wall Height, Load and Framing Dimension

Timber framing to comply with relevant sections and clauses of NZBC B1: Structure and NZBC B2: Durability. Timber framing must be in accordance with NZS3604 stud tables for load bearing or non-load bearing partitions. Furthermore;

- Minimum framing dimension is 90 x 45mm.
 - Nogs must be in place at a maximum of 800mm centres.
 - Maximum stud spacing's are 600mm centres.
 - The fire rated walls built close to boundary are also required to achieve post fire stability in either direction in accordance with the NZBC verification method B1/VM1, paragraph 2.2.4
- Refer to latest James Hardie Fire & Acoustic Design Manual figures and tables for further detail.

Underlay

For the type of allowable underlay refer to table below.

	EH Wind Zone	Other Wind Zone
Buildings <10m	RAB	Flexible Underlay
Buildings >10m	RAB	RAB

Fire Retardant Flexible Underlay

Install any Fire Retardant Flexible Underlay beneath the claddings, that complies with Table 23 of E2/AS1 and has a flammability index not exceeding 5.

RAB™ Board

One layer of James Hardie RAB™ Board fixed to entire framing.
 6mm RAB™ Board : Use 40 x 2.8mm fibre cement nail at 200mm centres
 9mm RAB™ Board : Use 50 x 2.8mm fibre cement nail at 200mm centres
 Fixing to be 12mm from sheet edges
 Reference to be made to the James Hardie Home RAB™ Pre-Cladding & RAB™ Board Installation Manual.

Cavity Batten

Use a nominal 20mm Timber Cavity Batten. Refer to Linea™ Oblique™ Horizontal Installation Technical Specification for installation instructions.

Linea™ Oblique™ Weatherboard Cladding - Horizontal

James Hardie Linea™ Oblique™ Weatherboard cladding fixed horizontally to external side of the timber framing. Refer to both Linea™ Oblique™ Horizontal Installation Technical Specification AND the James Hardie Fire & Acoustic Design Manual for information regarding fixing and finishing.

Wall Insulation

Insulation must be installed between studs and nogs. Use 90mm thick R2.2 glass wool insulation.

EPB Plasterboard Lining

NB: The installer must look for the Product Identification Code on the face paper to ensure the correct board type is installed. Refer to the Face Paper Product Identification Code table on this page.

One layer of 13mm EPB MultiSmart lining to internal side of framing. Vertical fixing only permitted. Use full height sheets where possible when fixing vertical. All sheet joints must be fixed over solid timber framing. Sheets shall be touch fitted.

Fixing of EPB Plasterboard Internal Linings

Fasteners

41mm x 6g High Thread Drywall Screws

Fastener Centres

Fix at 300mm centres around sheet perimeter and up all intermediate studs. Place fasteners 50mm from sheet corners along the top and bottom plates. On end studs place additional fasteners 50-60mm vertically and no close than 10mm from plate to stud connections. Place fasteners no closer than 12mm from the sheet edges and 18mm from sheet ends. Place fasteners at 200mm centres where sheet end butt joints occur.

Jointing and Finishing of EPB Plasterboard

All fastener heads stopped and all sheet joints reinforced with paper jointing tape and stopped. All in accordance with Elephant Plasterboard Installation Guide.

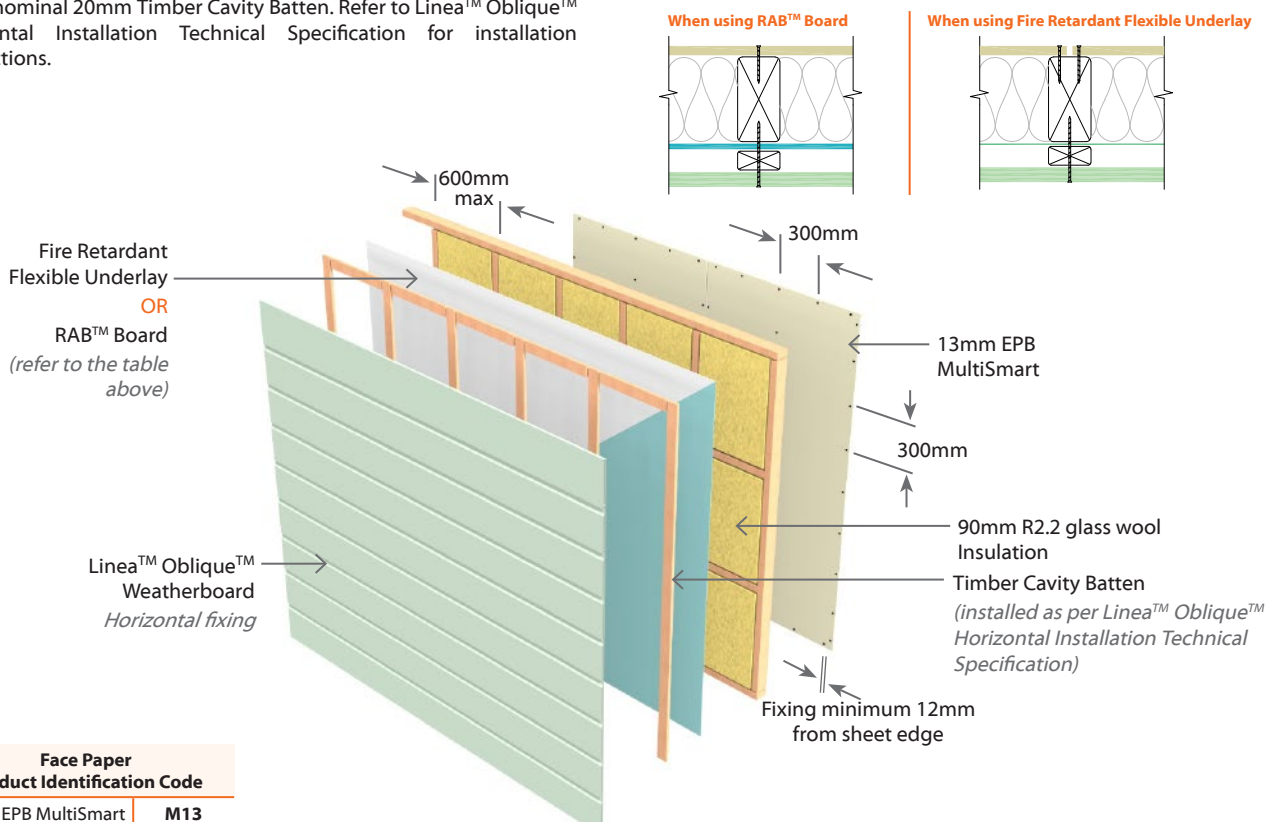

Face Paper Product Identification Code
13mm EPB MultiSmart M13

N.B. The above drawings are for illustrative purposes only.



EJOv1TL60 EPB & James Hardie Linea™ Oblique™ Weatherboard - Vertical Two Way FRR

External Wall - Timber Frame Load Bearing

System Number	Lining Suffix	FRR	Insulation	Noise Control STC	Lining Requirement
EJOv1TL60	-M13	60/60/60	R2.2 glass wool	47	1 x 13mm EPB MultiSmart on Internal side James Hardie Linea™ Oblique™ Weatherboard vertical to External side

Framing, Wall Height, Load and Framing Dimension

Timber framing to comply with relevant sections and clauses of NZBC B1: Structure and NZBC B2: Durability. Timber framing must be in accordance with NZS3604 stud tables for load bearing or non-load bearing partitions. Furthermore;

- Minimum framing dimension is 90 x 45mm.
 - Nogs must be in place at a maximum of 800mm centres.
 - Maximum stud spacing's are 600mm centres.
 - The fire rated walls built close to boundary are also required to achieve post fire stability in either direction in accordance with the NZBC verification method B1/VM1, paragraph 2.2.4
- Refer to latest James Hardie Fire & Acoustic Design Manual figures and tables for further detail.

Underlay

For the type of allowable underlay refer to table below.

	EH Wind Zone	Other Wind Zone
Buildings <10m	RAB	Flexible Underlay
Buildings >10m	RAB	RAB

Fire Retardant Flexible Underlay

Install any Fire Retardant Flexible Underlay beneath the claddings, that complies with Table 23 of E2/AS1 and has a flammability index not exceeding 5.

RAB™ Board

One layer of James Hardie RAB™ Board fixed to entire framing.
 6mm RAB™ Board : Use 40 x 2.8mm fibre cement nail at 200mm centres
 9mm RAB™ Board : Use 50 x 2.8mm fibre cement nail at 200mm centres
 Fixing to be 12mm from sheet edges
 Reference to be made to the James Hardie Home RAB™ Pre-Cladding & RAB™ Board Installation Manual.

Cavity Batten

Use a 20mm James Hardie Horizontal Timber Cavity Batten. Refer to Linea™ Oblique™ Vertical Installation Technical Specification for installation instructions.

Linea™ Oblique™ Weatherboard Cladding - Vertical

James Hardie Linea™ Oblique™ Weatherboard cladding fixed vertically to external side of the timber framing. Refer to both Linea™ Oblique™ Vertical Installation Technical Specification AND the James Hardie Fire & Acoustic Design Manual for information regarding fixing and finishing.

Wall Insulation

Insulation must be installed between studs and nogs. Use 90mm thick R2.2 glass wool insulation.

EPB Plasterboard Lining

NB: The installer must look for the Product Identification Code on the face paper to ensure the correct board type is installed. Refer to the Face Paper Product Identification Code table on this page.

One layer of 13mm EPB MultiSmart lining to internal side of framing. Vertical fixing only permitted. Use full height sheets where possible when fixing vertical. All sheet joints must be fixed over solid timber framing. Sheets shall be touch fitted.

Fixing of EPB Plasterboard Internal Linings

Fasteners

41mm x 6g High Thread Drywall Screws

Fastener Centres

Fix at 300mm centres around sheet perimeter and up all intermediate studs. Place fasteners 50mm from sheet corners along the top and bottom plates. On end studs place additional fasteners 50-60mm vertically and no close than 10mm from plate to stud connections. Place fasteners no closer than 12mm from the sheet edges and 18mm from sheet ends. Place fasteners at 200mm centres where sheet end butt joints occur.

Jointing and Finishing of EPB Plasterboard

All fastener heads stopped and all sheet joints reinforced with paper jointing tape and stopped. All in accordance with Elephant Plasterboard Installation Guide.

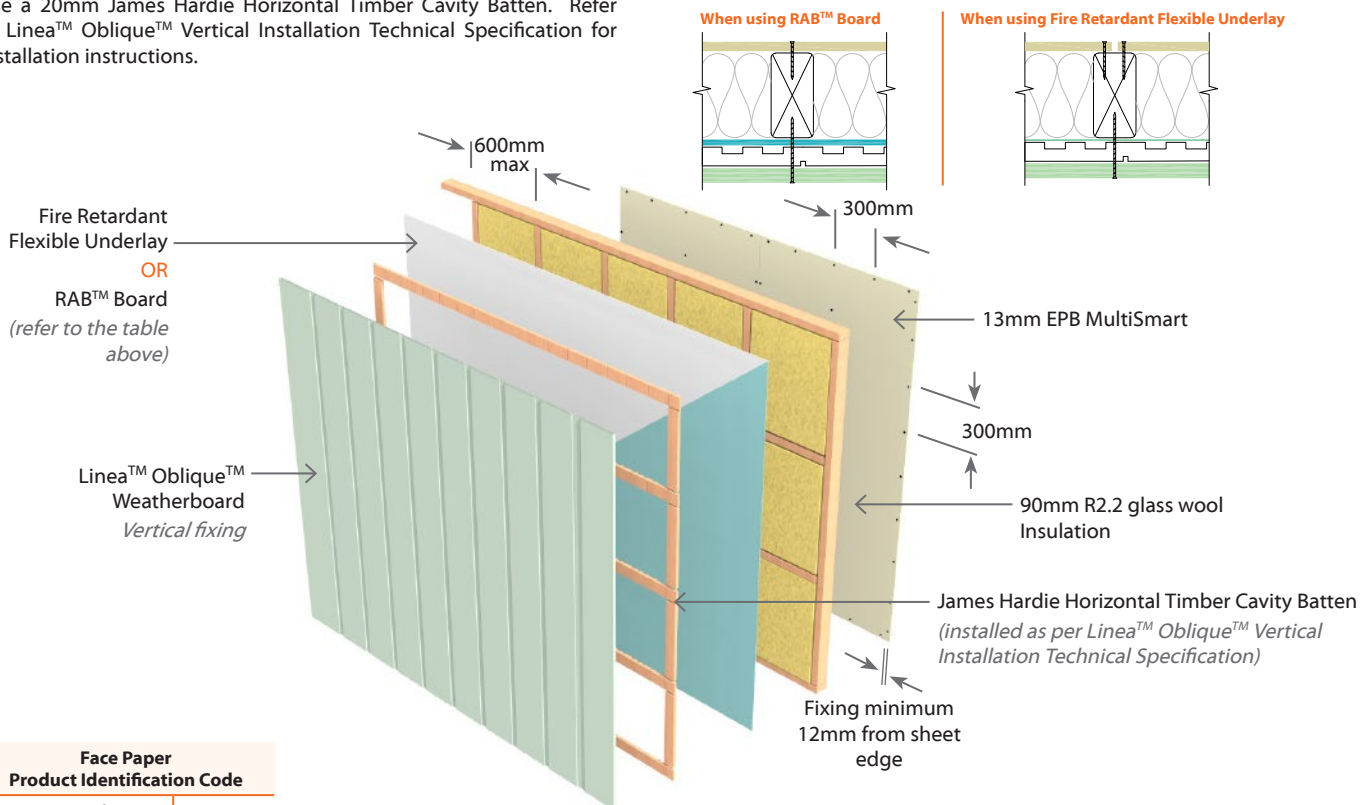

Face Paper Product Identification Code	
13mm EPB MultiSmart	M13

N.B. The above drawings are for illustrative purposes only.



EJW1TL30

EPB & Hardie™ Plank Weatherboard

Two Way FRR

External Wall - Timber Frame

Load Bearing

System Number	Lining Suffix	FRR	Insulation	Noise Control STC	Lining Requirement
EJW1TL30	-F10	30/30/30	R2.2 glass wool	45	1 x 10mm EPB FireSmart on Internal side Hardie™ Plank Weatherboard to External side

Framing, Wall Height, Load and Framing Dimension

Timber framing to comply with relevant sections and clauses of NZBC B1: Structure and NZBC B2: Durability. Timber framing must be in accordance with NZS3604 stud tables for load bearing or non-load bearing partitions. Furthermore;

- Minimum framing dimension is 90 x 45mm.
- Nogs must be in place at a maximum of 800mm centres.
- Maximum stud spacing's are 600mm centres.
- The fire rated walls built close to boundary are also required to achieve post fire stability in either direction in accordance with the NZBC verification method B1/VM1, paragraph 2.2.4 Refer to latest James Hardie Fire & Acoustic Design Manual figures and tables for further detail.

Underlay

Fire Retardant Flexible Underlay

Install any Fire Retardant Flexible Underlay beneath the claddings, that complies with Table 23 of E2/AS1 and has a flammability index not exceeding 5.

Cavity Batten

When Cavity Batten is required, use a nominal 20mm Timber Cavity Batten. Refer to Hardie™ Plank Weatherboards Technical Specification for installation instructions.

When Cladding can be directly fixed without a cavity batten then a fire retardant flexible underlay must be used.

Hardie™ Plank Weatherboard Cladding

Hardie™ Plank Weatherboard cladding to external side of the timber framing. Consider the nail length required depending on the type of fixing i.e. Cavity fixing or Direct fixing. Refer to both Hardie™ Plank Weatherboards Technical Specification AND the James Hardie Fire & Acoustic Design Manual for information regarding fixing and finishing.

Wall Insulation

Insulation must be installed between studs and nogs. Use 90mm thick R2.2 glass wool insulation.

EPB Plasterboard Lining

NB: The installer must look for the Product Identification Code on the face paper to ensure the correct board type is installed. Refer to the Face Paper Product Identification Code table on this page.

One layer of 10mm EPB FireSmart lining to internal side of framing. Vertical fixing only permitted. Use full height sheets where possible when fixing vertical. All sheet joints must be fixed over solid timber framing. Sheets shall be touch fitted.

Fixing of EPB Plasterboard Internal Linings

Fasteners

41mm x 6g High Thread Drywall Screws

Fastener Centres

Fix at 300mm centres around sheet perimeter and up all intermediate studs. Place fasteners 50mm from sheet corners along the top and bottom plates. On end studs place additional fasteners 50-60mm vertically and no close than 10mm from plate to stud connections.

Place fasteners no closer than 12mm from the sheet edges and 18mm from sheet ends. Place fasteners at 200mm centres where sheet end butt joints occur.

Jointing and Finishing of EPB Plasterboard

All fastener heads stopped and all sheet joints reinforced with paper jointing tape and stopped. All in accordance with Elephant Plasterboard Installation Guide.

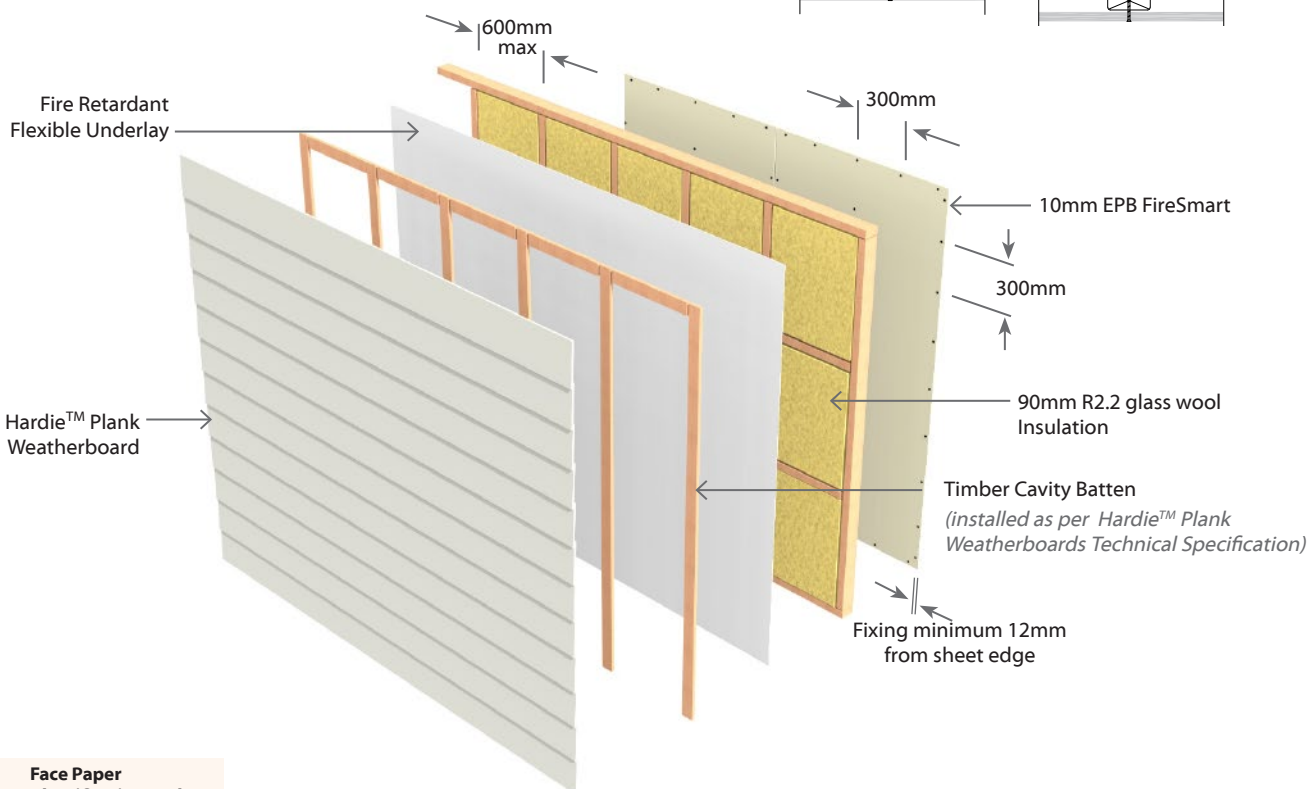

Face Paper	Product Identification Code
10mm EPB FireSmart	F10

N.B. The above drawings are for illustrative purposes only.



EJW1TL60 EPB & Hardie™ Plank Weatherboard Two Way FRR

External Wall - Timber Frame Load Bearing

System Number	Lining Suffix	FRR	Insulation	Noise Control STC	Lining Requirement
EJW1TL60	-M13	60/60/60	Hardie™ Mineral	46	1 x 13mm EPB MultiSmart on Internal side Hardie™ Plank Weatherboard to External side

Framing, Wall Height, Load and Framing Dimension

Timber framing to comply with relevant sections and clauses of NZBC B1: Structure and NZBC B2: Durability. Timber framing must be in accordance with NZS3604 stud tables for load bearing or non-load bearing partitions. Furthermore;

- Minimum framing dimension is 90 x 45mm.
- Nogs must be in place at a maximum of 800mm centres.
- Maximum stud spacing's are 600mm centres.
- The fire rated walls built close to boundary are also required to achieve post fire stability in either direction in accordance with the NZBC verification method B1/VM1, paragraph 2.2.4 Refer to latest James Hardie Fire & Acoustic Design Manual figures and tables for further detail.

Underlay

Fire Retardant Flexible Underlay

Install any Fire Retardant Flexible Underlay beneath the claddings, that complies with Table 23 of E2/AS1 and has a flammability index not exceeding 5.

Cavity Batten

When Cavity Batten is required, use a nominal 20mm Timber Cavity Batten. Refer to Hardie™ Plank Weatherboards Technical Specification for installation instructions.

When Cladding can be directly fixed without a cavity batten then a fire retardant flexible underlay must be used.

Hardie™ Plank Weatherboard Cladding

Hardie™ Plank Weatherboard cladding to external side of the timber framing. Consider the nail length required depending on the type of fixing i.e. Cavity fixing or Direct fixing. Refer to both Hardie™ Plank Weatherboards Technical Specification AND the James Hardie Fire & Acoustic Design Manual for information regarding fixing and finishing.

Wall Insulation

Insulation must be installed between studs and nogs. Use Hardie™ Mineral insulation.

EPB Plasterboard Lining

NB: The installer must look for the Product Identification Code on the face paper to ensure the correct board type is installed. Refer to the Face Paper Product Identification Code table on this page.

One layer of 13mm EPB MultiSmart lining to internal side of framing. Vertical fixing only permitted. Use full height sheets where possible when fixing vertical. All sheet joints must be fixed over solid timber framing. Sheets shall be touch fitted.

Fixing of EPB Plasterboard Internal Linings

Fasteners

41mm x 6g High Thread Drywall Screws

Fastener Centres

Fix at 300mm centres around sheet perimeter and up all intermediate studs. Place fasteners 50mm from sheet corners along the top and bottom plates. On end studs place additional fasteners 50-60mm vertically and no close than 10mm from plate to stud connections.

Place fasteners no closer than 12mm from the sheet edges and 18mm from sheet ends. Place fasteners at 200mm centres where sheet end butt joints occur.

Jointing and Finishing of EPB Plasterboard

All fastener heads stopped and all sheet joints reinforced with paper jointing tape and stopped. All in accordance with Elephant Plasterboard Installation Guide.

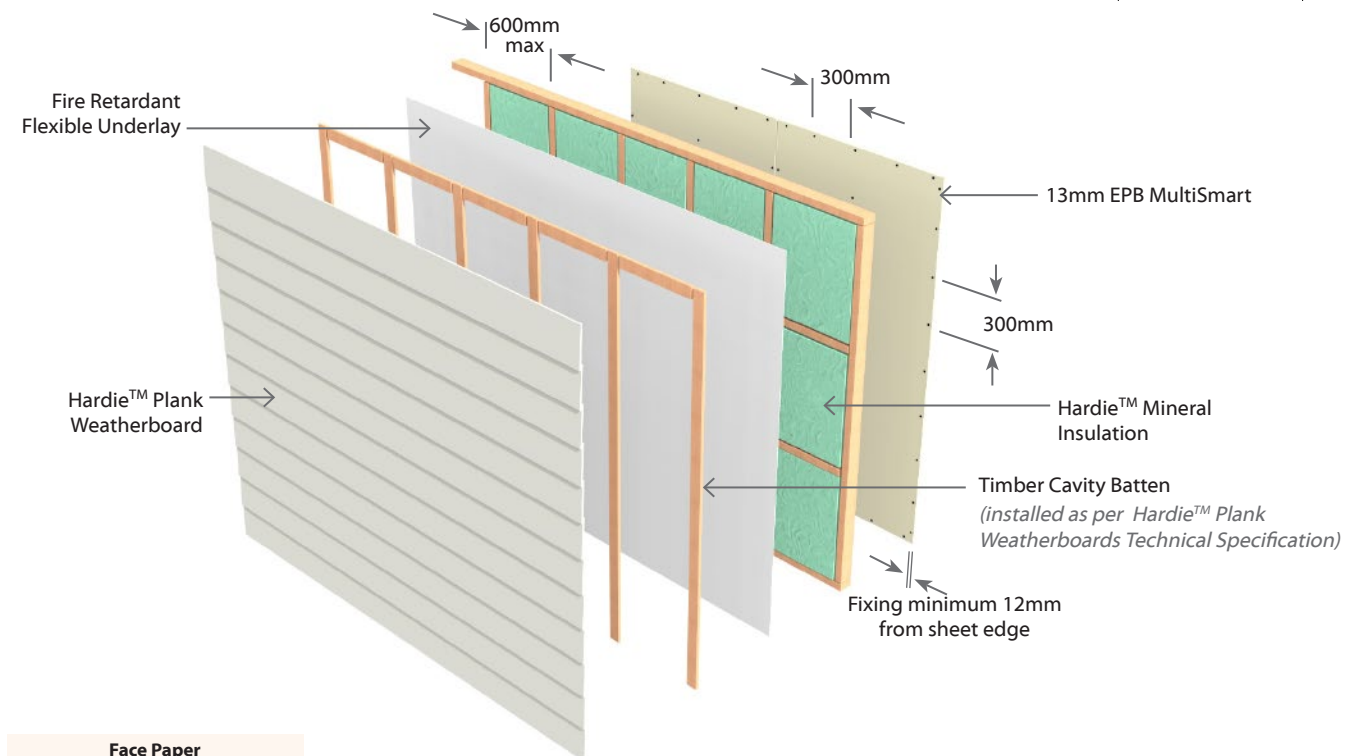
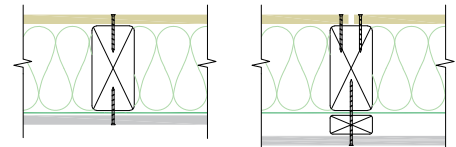

Face Paper Product Identification Code
13mm EPB MultiSmart M13

N.B. The above drawings are for illustrative purposes only.

EJSh1TL30

EPB & James Hardie Stria™ Cladding - Horizontal

Two Way FRR

External Wall - Timber Frame

Load Bearing

System Number	Lining Suffix	FRR	Insulation	Noise Control STC	Lining Requirement
EJSh1TL30	-F10	30/30/30	R2.2 glass wool	46	1 x 10mm EPB FireSmart on Internal side James Hardie Stria™ Cladding horizontal to External side

Framing, Wall Height, Load and Framing Dimension

Timber framing to comply with relevant sections and clauses of NZBC B1: Structure and NZBC B2: Durability. Timber framing must be in accordance with NZS3604 stud tables for load bearing or non-load bearing partitions. Furthermore;

- Minimum framing dimension is 90 x 45mm.
 - Nogs must be in place at a maximum of 800mm centres.
 - Maximum stud spacing's are 600mm centres.
 - The fire rated walls built close to boundary are also required to achieve post fire stability in either direction in accordance with the NZBC verification method B1/VM1, paragraph 2.2.4
- Refer to latest James Hardie Fire & Acoustic Design Manual figures and tables for further detail.

Underlay

For the type of allowable underlay refer to table below.

	EH Wind Zone	Other Wind Zone
Buildings <10m	RAB	Flexible Underlay
Buildings >10m	RAB	RAB

Fire Retardant Flexible Underlay

Install any Fire Retardant Flexible Underlay beneath the claddings, that complies with Table 23 of E2/AS1 and has a flammability index not exceeding 5.

RAB™ Board

One layer of James Hardie RAB™ Board fixed to entire framing.
6mm RAB™ Board : Use 40 x 2.8mm fibre cement nail at 200mm centres
9mm RAB™ Board : Use 50 x 2.8mm fibre cement nail at 200mm centres
Fixing to be 12mm from sheet edges

Reference to be made to the James Hardie Home RAB™ Pre-Cladding & RAB™ Board Installation Manual.

Cavity Batten

Use a nominal 20mm Timber Cavity Batten. Refer to Stria™ Cladding Timber Cavity Batten Horizontal Technical Specification for installation instructions.

James Hardie Stria™ Cladding - Horizontal

James Hardie Stria™ Cladding fixed horizontally to external side of the timber framing. Refer to both Stria™ Cladding Timber Cavity Batten Horizontal Technical Specification AND the James Hardie Fire & Acoustic Design Manual for information regarding fixing and finishing.

Wall Insulation

Insulation must be installed between studs and nogs. Use 90mm thick R2.2 glass wool insulation.

EPB Plasterboard Lining

NB: The installer must look for the Product Identification Code on the face paper to ensure the correct board type is installed. Refer to the Face Paper Product Identification Code table on this page.

One layer of 10mm EPB FireSmart lining to internal side of framing. Vertical fixing only permitted. Use full height sheets where possible when fixing vertical. All sheet joints must be fixed over solid timber framing. Sheets shall be touch fitted.

Fixing of EPB Plasterboard Internal Linings

Fasteners

41mm x 6g High Thread Drywall Screws

Fastener Centres

Fix at 300mm centres around sheet perimeter and up all intermediate studs. Place fasteners 50mm from sheet corners along the top and bottom plates. On end studs place additional fasteners 50-60mm vertically and no close than 10mm from plate to stud connections.

Place fasteners no closer than 12mm from the sheet edges and 18mm from sheet ends. Place fasteners at 200mm centres where sheet end butt joints occur.

Jointing and Finishing of EPB Plasterboard

All fastener heads stopped and all sheet joints reinforced with paper jointing tape and stopped. All in accordance with Elephant Plasterboard Installation Guide.

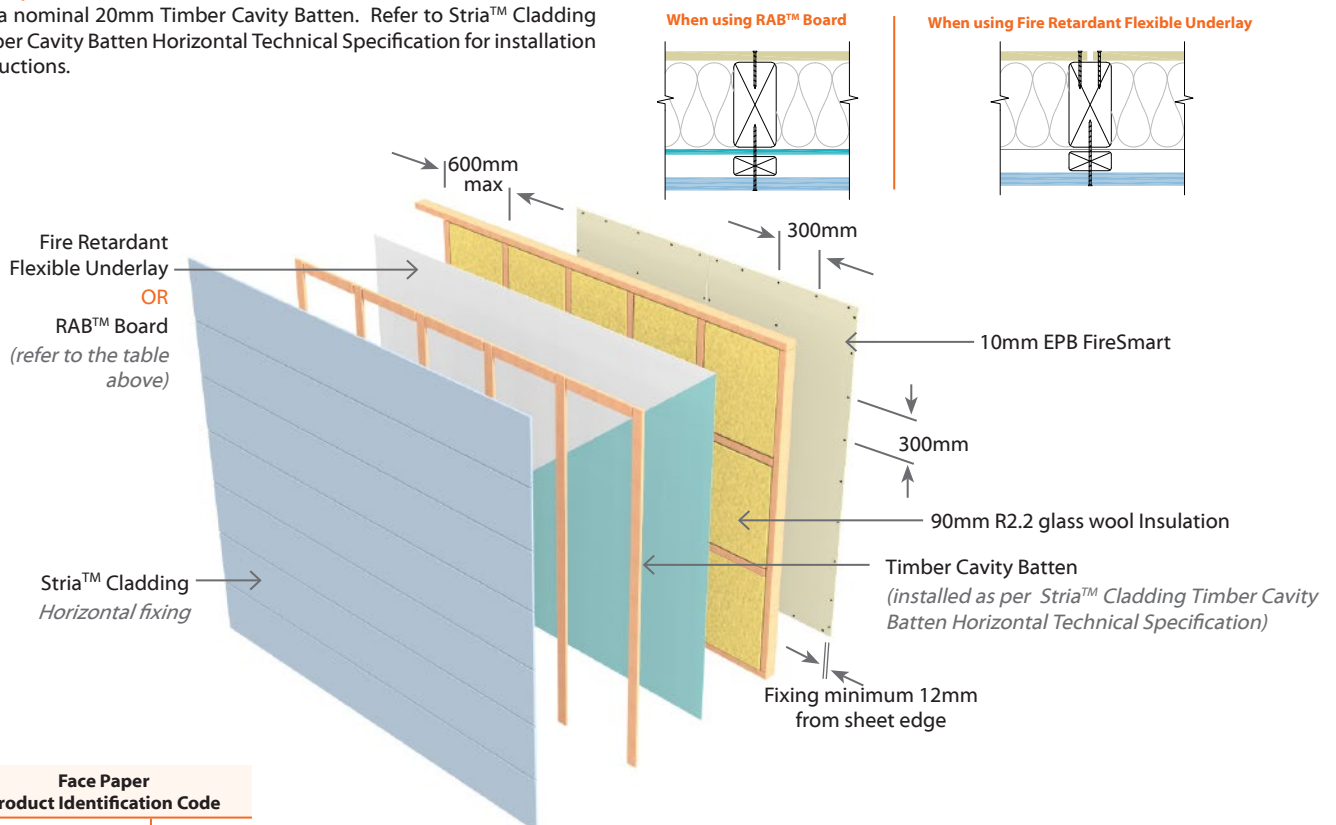

Face Paper	Product Identification Code
10mm EPB FireSmart	F10

N.B. The above drawings are for illustrative purposes only.



EJSv1TL30 EPB & James Hardie Stria™ Cladding - Vertical Two Way FRR

External Wall - Timber Frame Load Bearing

System Number	Lining Suffix	FRR	Insulation	Noise Control STC	Lining Requirement
EJSv1TL30	-F10	30/30/30	R2.2 glass wool	46	1 x 10mm EPB FireSmart on Internal side James Hardie Stria™ Cladding vertical to External side

Framing, Wall Height, Load and Framing Dimension

Timber framing to comply with relevant sections and clauses of NZBC B1: Structure and NZBC B2: Durability. Timber framing must be in accordance with NZS3604 stud tables for load bearing or non-load bearing partitions. Furthermore;

- Minimum framing dimension is 90 x 45mm.
 - Nogs must be in place at a maximum of 800mm centres.
 - Maximum stud spacing's are 600mm centres.
 - The fire rated walls built close to boundary are also required to achieve post fire stability in either direction in accordance with the NZBC verification method B1/VM1, paragraph 2.2.4
- Refer to latest James Hardie Fire & Acoustic Design Manual figures and tables for further detail.

Underlay

For the type of allowable underlay refer to table below.

	EH Wind Zone	Other Wind Zone
Buildings <10m	RAB	Flexible Underlay
Buildings >10m	RAB	RAB

Fire Retardant Flexible Underlay

Install any Fire Retardant Flexible Underlay beneath the claddings, that complies with Table 23 of E2/AS1 and has a flammability index not exceeding 5.

RAB™ Board

One layer of James Hardie RAB™ Board fixed to entire framing.
6mm RAB™ Board : Use 40 x 2.8mm fibre cement nail at 200mm centres
9mm RAB™ Board : Use 50 x 2.8mm fibre cement nail at 200mm centres
Fixing to be 12mm from sheet edges

Reference to be made to the James Hardie Home RAB™ Pre-Cladding & RAB™ Board Installation Manual.

Cavity Batten

Use a 20mm James Hardie Horizontal Timber Cavity Batten. Refer to Stria™ Cladding Vertical Technical Specification for installation instructions.

James Hardie Stria™ Cladding - Vertical

James Hardie Stria™ Cladding fixed vertically to external side of the timber framing. Refer to both Stria™ Cladding Vertical Technical Specification AND the James Hardie Fire & Acoustic Design Manual for information regarding fixing and finishing.

Wall Insulation

Insulation must be installed between studs and nogs. Use 90mm thick R2.2 glass wool insulation.

EPB Plasterboard Lining

NB: The installer must look for the Product Identification Code on the face paper to ensure the correct board type is installed. Refer to the Face Paper Product Identification Code table on this page.

One layer of 10mm EPB FireSmart lining to internal side of framing. Vertical fixing only permitted. Use full height sheets where possible when fixing vertical. All sheet joints must be fixed over solid timber framing. Sheets shall be touch fitted.

Fixing of EPB Plasterboard Internal Linings

Fasteners

41mm x 6g High Thread Drywall Screws

Fastener Centres

Fix at 300mm centres around sheet perimeter and up all intermediate studs. Place fasteners 50mm from sheet corners along the top and bottom plates. On end studs place additional fasteners 50-60mm vertically and no close than 10mm from plate to stud connections.

Place fasteners no closer than 12mm from the sheet edges and 18mm from sheet ends. Place fasteners at 200mm centres where sheet end butt joints occur.

Jointing and Finishing of EPB Plasterboard

All fastener heads stopped and all sheet joints reinforced with paper jointing tape and stopped. All in accordance with Elephant Plasterboard Installation Guide.

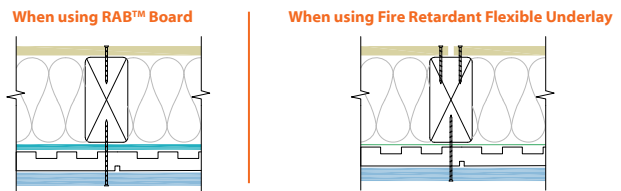
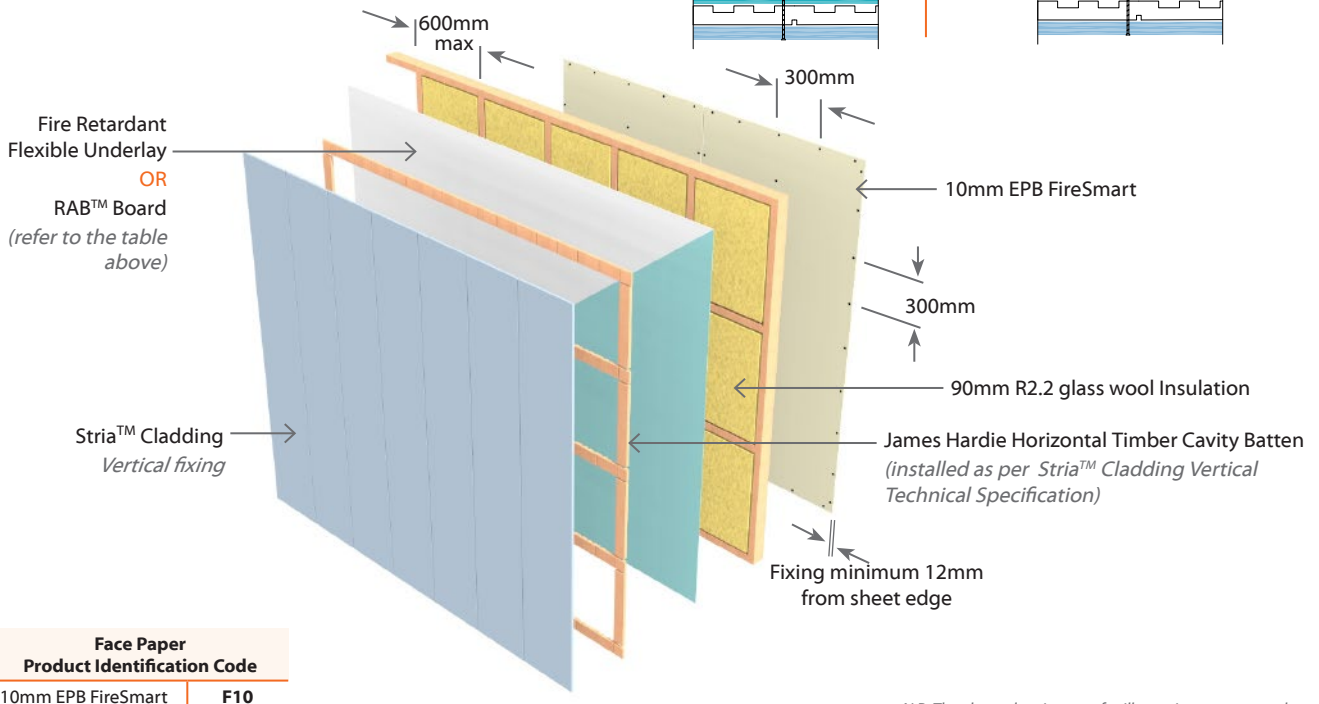

N.B. The above drawings are for illustrative purposes only.



EJSh1TL60

EPB & James Hardie Stria™ Cladding - Horizontal

Two Way FRR

External Wall - Timber Frame

Load Bearing

System Number	Lining Suffix	FRR	Insulation	Noise Control STC	Lining Requirement
EJSh1TL60	-M13	60/60/60	R2.2 glass wool	47	1 x 13mm EPB MultiSmart on Internal side James Hardie Stria™ Cladding horizontal to External side

Framing, Wall Height, Load and Framing Dimension

Timber framing to comply with relevant sections and clauses of NZBC B1: Structure and NZBC B2: Durability. Timber framing must be in accordance with NZS3604 stud tables for load bearing or non-load bearing partitions. Furthermore;

- Minimum framing dimension is 90 x 45mm.
- Nogs must be in place at a maximum of 800mm centres.
- Maximum stud spacing's are 600mm centres.
- The fire rated walls built close to boundary are also required to achieve post fire stability in either direction in accordance with the NZBC verification method B1/VM1, paragraph 2.2.4

Refer to latest James Hardie Fire & Acoustic Design Manual figures and tables for further detail.

Underlay

For the type of allowable underlay refer to table below.

	EH Wind Zone	Other Wind Zone
Buildings <10m	RAB	Flexible Underlay
Buildings >10m	RAB	RAB

Fire Retardant Flexible Underlay

Install any Fire Retardant Flexible Underlay beneath the claddings, that complies with Table 23 of E2/AS1 and has a flammability index not exceeding 5.

RAB™ Board

One layer of James Hardie RAB™ Board fixed to entire framing.

6mm RAB™ Board : Use 40 x 2.8mm fibre cement nail at 200mm centres

9mm RAB™ Board : Use 50 x 2.8mm fibre cement nail at 200mm centres

Fixing to be 12mm from sheet edges

Reference to be made to the James Hardie Home RAB™ Pre-Cladding & RAB™ Board Installation Manual.

Cavity Batten

Use a nominal 20mm Timber Cavity Batten. Refer to Stria™ Cladding Timber Cavity Batten Horizontal Technical Specification for installation instructions.

James Hardie Stria™ Cladding - Horizontal

James Hardie Stria™ Cladding fixed horizontally to external side of the timber framing. Refer to both Stria™ Cladding Timber Cavity Batten Horizontal Technical Specification AND the James Hardie Fire & Acoustic Design Manual for information regarding fixing and finishing.

Wall Insulation

Insulation must be installed between studs and nogs. Use 90mm thick R2.2 glass wool insulation.

EPB Plasterboard Lining

NB: The installer must look for the Product Identification Code on the face paper to ensure the correct board type is installed. Refer to the Face Paper Product Identification Code table on this page.

One layer of 13mm EPB MultiSmart lining to internal side of framing. Vertical fixing only permitted. Use full height sheets where possible when fixing vertical. All sheet joints must be fixed over solid timber framing. Sheets shall be touch fitted.

Fixing of EPB Plasterboard Internal Linings

Fasteners

41mm x 6g High Thread Drywall Screws

Fastener Centres

Fix at 300mm centres around sheet perimeter and up all intermediate studs. Place fasteners 50mm from sheet corners along the top and bottom plates. On end studs place additional fasteners 50-60mm vertically and no close than 10mm from plate to stud connections.

Place fasteners no closer than 12mm from the sheet edges and 18mm from sheet ends. Place fasteners at 200mm centres where sheet end butt joints occur.

Jointing and Finishing of EPB Plasterboard

All fastener heads stopped and all sheet joints reinforced with paper jointing tape and stopped. All in accordance with Elephant Plasterboard Installation Guide.

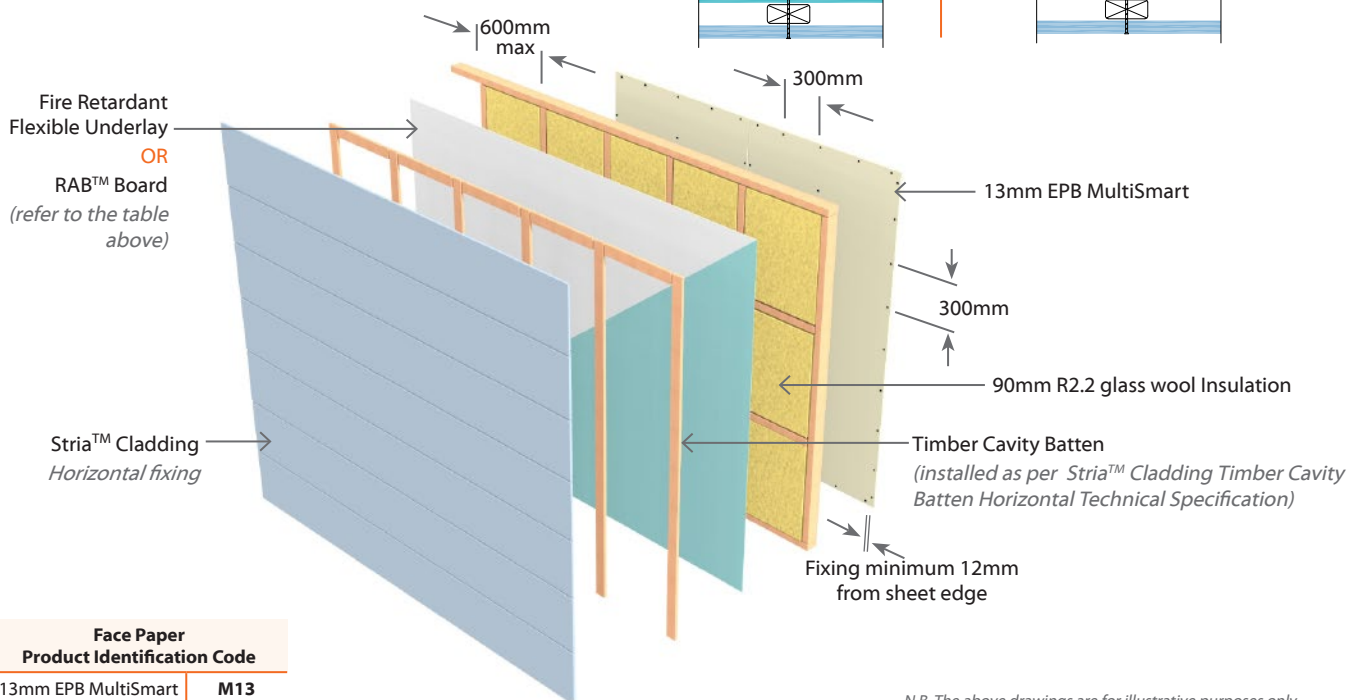

When using RAB™ Board

When using Fire Retardant Flexible Underlay

N.B. The above drawings are for illustrative purposes only.



EJSv1TL60

EPB & James Hardie Stria™ Cladding - Vertical

Two Way FRR

External Wall - Timber Frame

Load Bearing

System Number	Lining Suffix	FRR	Insulation	Noise Control STC	Lining Requirement
EJSv1TL60	-M13	60/60/60	R2.2 glass wool	47	1 x 13mm EPB MultiSmart on Internal side James Hardie Stria™ Cladding vertical to External side

Framing, Wall Height, Load and Framing Dimension

Timber framing to comply with relevant sections and clauses of NZBC B1: Structure and NZBC B2: Durability. Timber framing must be in accordance with NZS3604 stud tables for load bearing or non-load bearing partitions. Furthermore;

- Minimum framing dimension is 90 x 45mm.
- Nogs must be in place at a maximum of 800mm centres.
- Maximum stud spacing's are 600mm centres.
- The fire rated walls built close to boundary are also required to achieve post fire stability in either direction in accordance with the NZBC verification method B1/VM1, paragraph 2.2.4

Refer to latest James Hardie Fire & Acoustic Design Manual figures and tables for further detail.

Underlay

For the type of allowable underlay refer to table below.

	EH Wind Zone	Other Wind Zone
Buildings <10m	RAB	Flexible Underlay
Buildings >10m	RAB	RAB

Fire Retardant Flexible Underlay

Install any Fire Retardant Flexible Underlay beneath the claddings, that complies with Table 23 of E2/AS1 and has a flammability index not exceeding 5.

RAB™ Board

One layer of James Hardie RAB™ Board fixed to entire framing.

6mm RAB™ : Use 40 x 2.8mm fibre cement nail at 200mm centres

9mm RAB™ : Use 50 x 2.8mm fibre cement nail at 200mm centres

Fixing to be 12mm from sheet edges

Reference to be made to the James Hardie Home RAB™ Pre-Cladding & RAB™ Board Installation Manual.

Cavity Batten

Use a 20mm James Hardie Horizontal Timber Cavity Batten. Refer to Stria™ Cladding Vertical Technical Specification for installation instructions.

James Hardie Stria™ Cladding - Vertical

James Hardie Stria™ Cladding fixed vertically to external side of the timber framing. Refer to both Stria™ Cladding Vertical Technical Specification AND the James Hardie Fire & Acoustic Design Manual for information regarding fixing and finishing.

Wall Insulation

Insulation must be installed between studs and nogs. Use 90mm thick R2.2 glass wool insulation.

EPB Plasterboard Lining

NB: The installer must look for the Product Identification Code on the face paper to ensure the correct board type is installed. Refer to the Face Paper Product Identification Code table on this page.

One layer of 13mm EPB MultiSmart lining to internal side of framing. Vertical fixing only permitted. Use full height sheets where possible when fixing vertical. All sheet joints must be fixed over solid timber framing. Sheets shall be touch fitted.

Fixing of EPB Plasterboard Internal Linings

Fasteners

41mm x 6g High Thread Drywall Screws

Fastener Centres

Fix at 300mm centres around sheet perimeter and up all intermediate studs. Place fasteners 50mm from sheet corners along the top and bottom plates. On end studs place additional fasteners 50-60mm vertically and no close than 10mm from plate to stud connections.

Place fasteners no closer than 12mm from the sheet edges and 18mm from sheet ends. Place fasteners at 200mm centres where sheet end butt joints occur.

Jointing and Finishing of EPB Plasterboard

All fastener heads stopped and all sheet joints reinforced with paper jointing tape and stopped. All in accordance with Elephant Plasterboard Installation Guide.

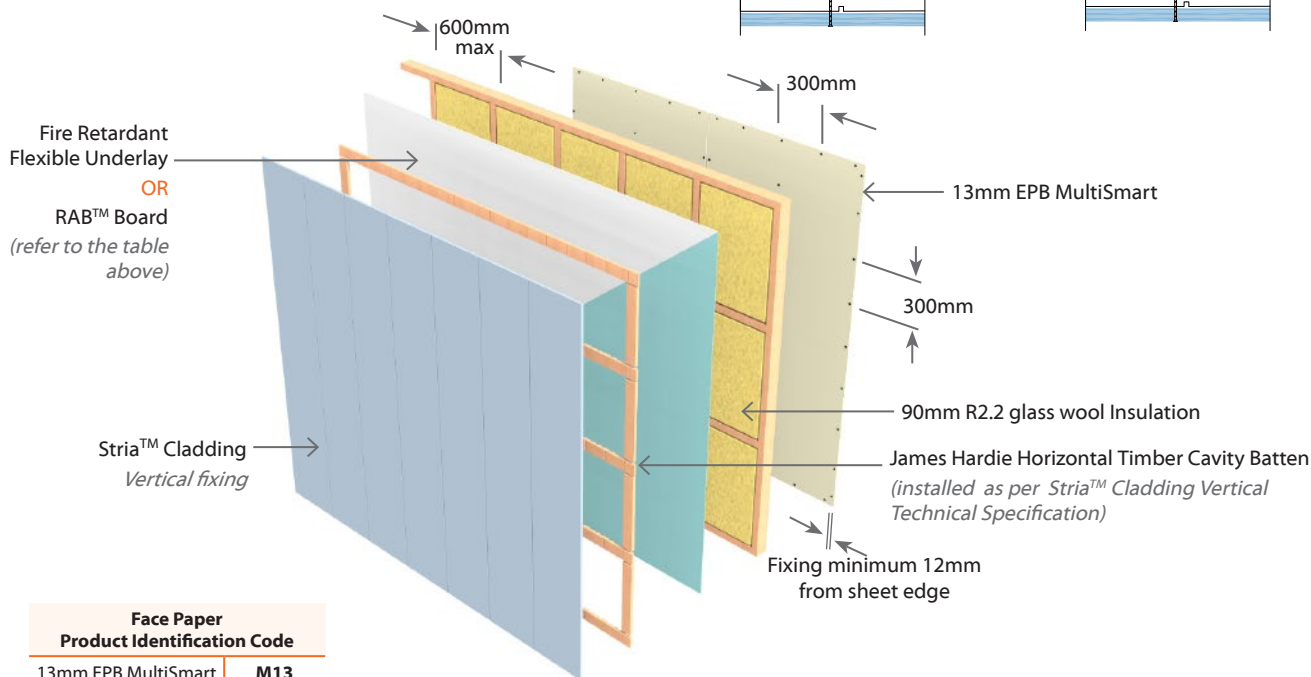

N.B. The above drawings are for illustrative purposes only.



EJRS1TL30

EPB & James Hardie Stria™ Cladding & RAB™ Board with CLD™ Battens

Two Way FRR

External Wall - Timber Frame

Load Bearing

System Number	Lining Suffix	FRR	Insulation	Noise Control STC	Lining Requirement
EJRS1TL30	-F10	30/30/30	R2.2 glass wool	46	1 x 10mm EPB FireSmart on Internal side James Hardie Stria™ Cladding and RAB™ Board with CLD™ Structural Cavity Batten to External side

Framing, Wall Height, Load and Framing Dimension

Timber framing to comply with relevant sections and clauses of NZBC B1: Structure and NZBC B2: Durability. Timber framing must be in accordance with NZS3604 stud tables for load bearing or non-load bearing partitions. Furthermore;

- Minimum framing dimension is 90 x 45mm.
 - Nogs must be in place at a maximum of 800mm centres.
 - Maximum stud spacing's are 600mm centres.
 - The fire rated walls built close to boundary are also required to achieve post fire stability in either direction in accordance with the NZBC verification method B1/VM1, paragraph 2.2.4
- Refer to latest James Hardie Fire & Acoustic Design Manual figures and tables for further detail.

Underlay

RAB™ Board

One layer of James Hardie RAB™ Board fixed to entire framing.
 6mm RAB™ Board : Use 40 x 2.8mm fibre cement nail at 150mm centres
 9mm RAB™ Board : Use 50 x 2.8mm fibre cement nail at 150mm centres
 Fixing to be 12mm from sheet edges
 Reference to be made to the James Hardie Home RAB™ Pre-Cladding & RAB™ Board Installation Manual.

Cavity Batten

Use 70 x 19mm CLD™ Structural Cavity Batten. Refer to Stria™ Cladding CLD Structural Cavity Batten Technical Specification for installation instructions.

James Hardie Stria™ Cladding

James Hardie Stria™ Cladding fixed horizontally to external side of the timber framing. Refer to both Stria™ Cladding CLD Structural Cavity Batten Technical Specification AND the James Hardie Fire & Acoustic Design Manual for information regarding fixing and finishing.

Wall Insulation

Insulation must be installed between studs and nogs. Use 90mm thick R2.2 glass wool insulation.

EPB Plasterboard Lining

NB: The installer must look for the Product Identification Code on the face paper to ensure the correct board type is installed. Refer to the Face Paper Product Identification Code table on this page.

One layer of 10mm EPB FireSmart lining to internal side of framing. Vertical fixing only permitted. Use full height sheets where possible when fixing vertical. All sheet joints must be fixed over solid timber framing. Sheets shall be touch fitted.

Fixing of EPB Plasterboard Internal Linings

Fasteners

41mm x 6g High Thread Drywall Screws

Fastener Centres

Fix at 300mm centres around sheet perimeter and up all intermediate studs. Place fasteners 50mm from sheet corners along the top and bottom plates. On end studs place additional fasteners 50-60mm vertically and no close than 10mm from plate to stud connections. Place fasteners no closer than 12mm from the sheet edges and 18mm from sheet ends. Place fasteners at 200mm centres where sheet end butt joints occur.

Jointing and Finishing of EPB Plasterboard

All fastener heads stopped and all sheet joints reinforced with paper jointing tape and stopped. All in accordance with Elephant Plasterboard Installation Guide.

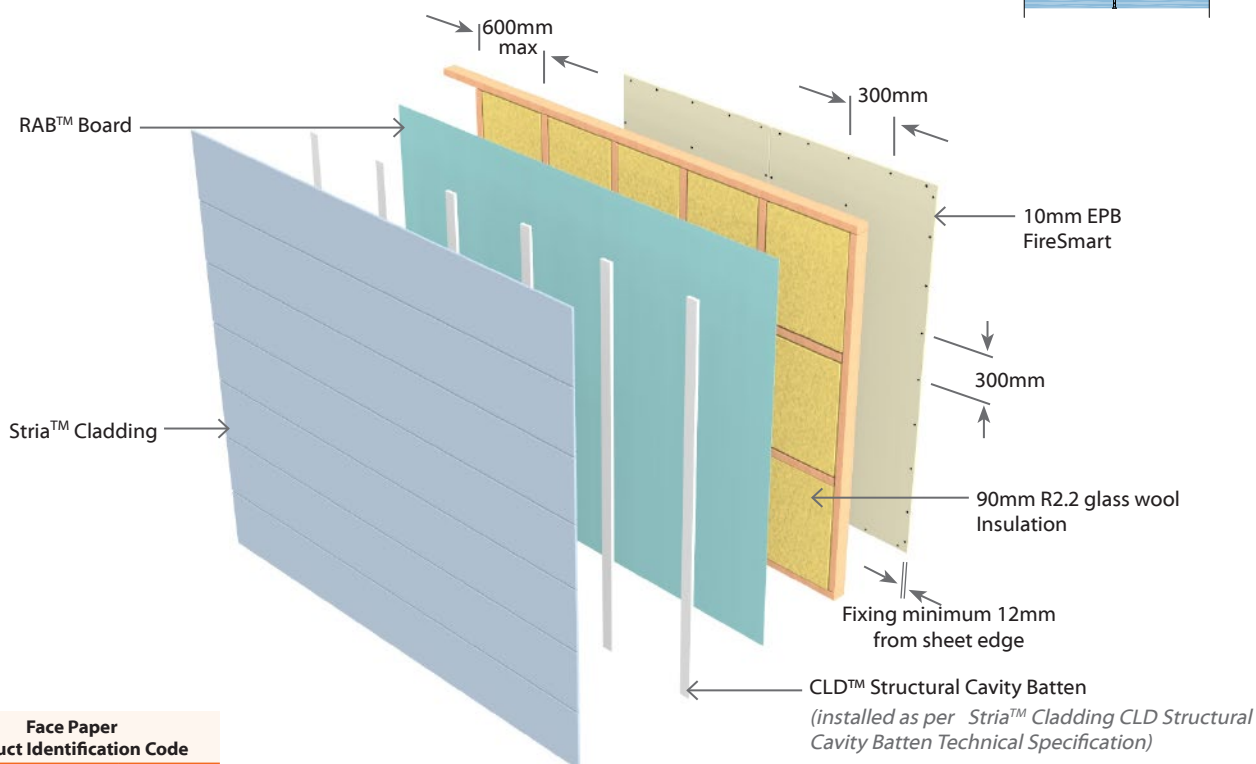

Face Paper Product Identification Code
10mm EPB FireSmart F10

N.B. The above drawings are for illustrative purposes only.



EJRS1TL60 EPB & James Hardie Stria™ Cladding & RAB™ Board with CLD™ Battens | Two Way FRR

External Wall - Timber Frame Load Bearing

System Number	Lining Suffix	FRR	Insulation	Noise Control STC	Lining Requirement
EJRS1TL60	-M13	60/60/60	Hardie™ Mineral	47	1 x 13mm EPB MultiSmart on Internal side James Hardie Stria™ Cladding and RAB™ Board with CLD™ Structural Cavity Batten to External side

Framing, Wall Height, Load and Framing Dimension

Timber framing to comply with relevant sections and clauses of NZBC B1: Structure and NZBC B2: Durability. Timber framing must be in accordance with NZS3604 stud tables for load bearing or non-load bearing partitions. Furthermore;

- Minimum framing dimension is 90 x 45mm.
 - Nogs must be in place at a maximum of 800mm centres.
 - Maximum stud spacing's are 600mm centres.
 - The fire rated walls built close to boundary are also required to achieve post fire stability in either direction in accordance with the NZBC verification method B1/VM1, paragraph 2.2.4
- Refer to latest James Hardie Fire & Acoustic Design Manual figures and tables for further detail.

Underlay

RAB™ Board

One layer of James Hardie RAB™ Board fixed to entire framing.
 6mm RAB™ Board : Use 40 x 2.8mm fibre cement nail at 150mm centres
 9mm RAB™ Board : Use 50 x 2.8mm fibre cement nail at 150mm centres
 Fixing to be 12mm from sheet edges
 Reference to be made to the James Hardie Home RAB™ Pre-Cladding & RAB™ Board Installation Manual.

Cavity Batten

Use 70 x 19mm CLD™ Structural Cavity Batten. Refer to Stria™ Cladding CLD Structural Cavity Batten Technical Specification for installation instructions.

James Hardie Stria™ Cladding

James Hardie Stria™ Cladding fixed horizontally to external side of the timber framing. Refer to both Stria™ Cladding CLD Structural Cavity Batten Technical Specification AND the James Hardie Fire & Acoustic Design Manual for information regarding fixing and finishing.

Wall Insulation

Insulation must be installed between studs and nogs. Use Hardie™ Mineral insulation.

EPB Plasterboard Lining

NB: The installer must look for the Product Identification Code on the face paper to ensure the correct board type is installed. Refer to the Face Paper Product Identification Code table on this page.

One layer of 13mm EPB MultiSmart lining to internal side of framing. Vertical fixing only permitted. Use full height sheets where possible when fixing vertical. All sheet joints must be fixed over solid timber framing. Sheets shall be touch fitted.

Fixing of EPB Plasterboard Internal Linings

Fasteners

41mm x 6g High Thread Drywall Screws

Fastener Centres

Fix at 300mm centres around sheet perimeter and up all intermediate studs. Place fasteners 50mm from sheet corners along the top and bottom plates. On end studs place additional fasteners 50-60mm vertically and no close than 10mm from plate to stud connections.

Place fasteners no closer than 12mm from the sheet edges and 18mm from sheet ends. Place fasteners at 200mm centres where sheet end butt joints occur.

Jointing and Finishing of EPB Plasterboard

All fastener heads stopped and all sheet joints reinforced with paper jointing tape and stopped. All in accordance with Elephant Plasterboard Installation Guide.

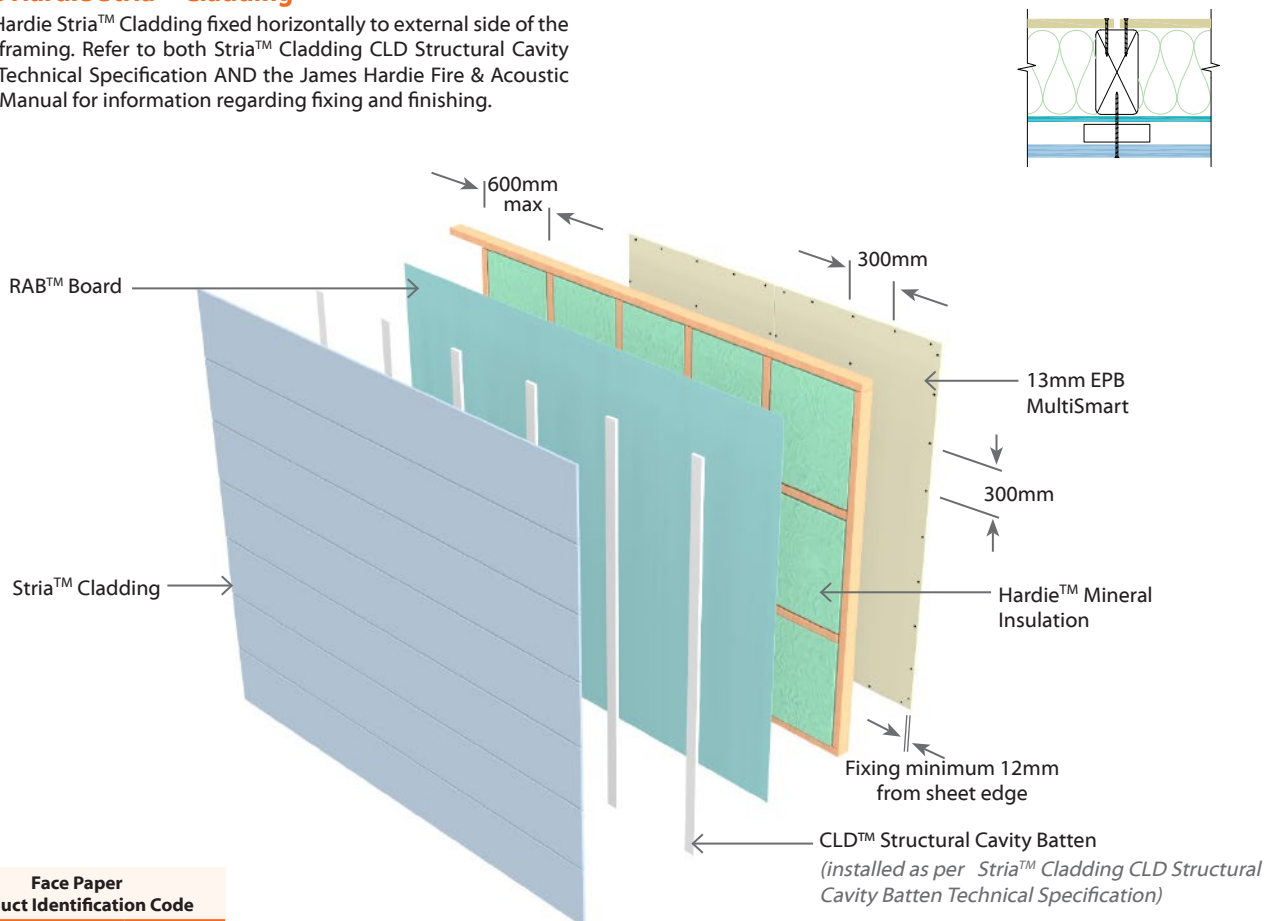

N.B. The above drawings are for illustrative purposes only.

EJF1TL30

EPB & James Hardie Hardie™ Flex Sheet

Two Way FRR

External Wall - Timber Frame

Load Bearing

System Number	Lining Suffix	FRR	Insulation	Noise Control STC	Lining Requirement
EJF1TL30	-F10	30/30/30	R2.2 glass wool	42	1 x 10mm EPB FireSmart on Internal side James Hardie Hardie™ Flex Sheet to External side

Framing, Wall Height, Load and Framing Dimension

Timber framing to comply with relevant sections and clauses of NZBC B1: Structure and NZBC B2: Durability. Timber framing must be in accordance with NZS3604 stud tables for load bearing or non-load bearing partitions. Furthermore;

- Minimum framing dimension is 90 x 45mm.
- Nogs must be in place at a maximum of 800mm centres.
- Maximum stud spacing's are 600mm centres.
- The fire rated walls built close to boundary are also required to achieve post fire stability in either direction in accordance with the NZBC verification method B1/VM1, paragraph 2.2.4 Refer to latest James Hardie Fire & Acoustic Design Manual figures and tables for further detail.

Underlay

Fire Retardant Flexible Underlay

Install any Fire Retardant Flexible Underlay beneath the claddings, that complies with Table 23 of E2/AS1 and has a flammability index not exceeding 5.

Cavity Batten

When Cavity Batten is required, use a nominal 20mm Timber Cavity Batten. Refer to James Hardie Hardie™ Flex Sheet Technical Specification.

When Cladding can be directly fixed without a cavity batten then a fire retardant flexible underlay must be used.

James Hardie Hardie™ Flex Sheet Cladding

James Hardie Hardie™ Flex Sheet cladding to external side of the timber framing. Consider the nail length required depending on the type of fixing i.e. Cavity fixing or Direct fixing. Refer to both James Hardie Hardie™ Flex Sheet Technical Specification AND the James Hardie Fire & Acoustic Design Manual for information regarding fixing and finishing.

Wall Insulation

Insulation must be installed between studs and nogs. Use 90mm thick R2.2 glass wool insulation.

EPB Plasterboard Lining

NB: The installer must look for the Product Identification Code on the face paper to ensure the correct board type is installed. Refer to the Face Paper Product Identification Code table on this page.

One layer of 10mm EPB FireSmart lining to internal side of framing. Vertical fixing only permitted. Use full height sheets where possible when fixing vertical. All sheet joints must be fixed over solid timber framing. Sheets shall be touch fitted.

Fixing of EPB Plasterboard Internal Linings

Fasteners

41mm x 6g High Thread Drywall Screws

Fastener Centres

Fix at 300mm centres around sheet perimeter and up all intermediate studs. Place fasteners 50mm from sheet corners along the top and bottom plates. On end studs place additional fasteners 50-60mm vertically and no closer than 10mm from plate to stud connections.

Place fasteners no closer than 12mm from the sheet edges and 18mm from sheet ends. Place fasteners at 200mm centres where sheet end butt joints occur.

Jointing and Finishing of EPB Plasterboard

All fastener heads stopped and all sheet joints reinforced with paper jointing tape and stopped. All in accordance with Elephant Plasterboard Installation Guide.

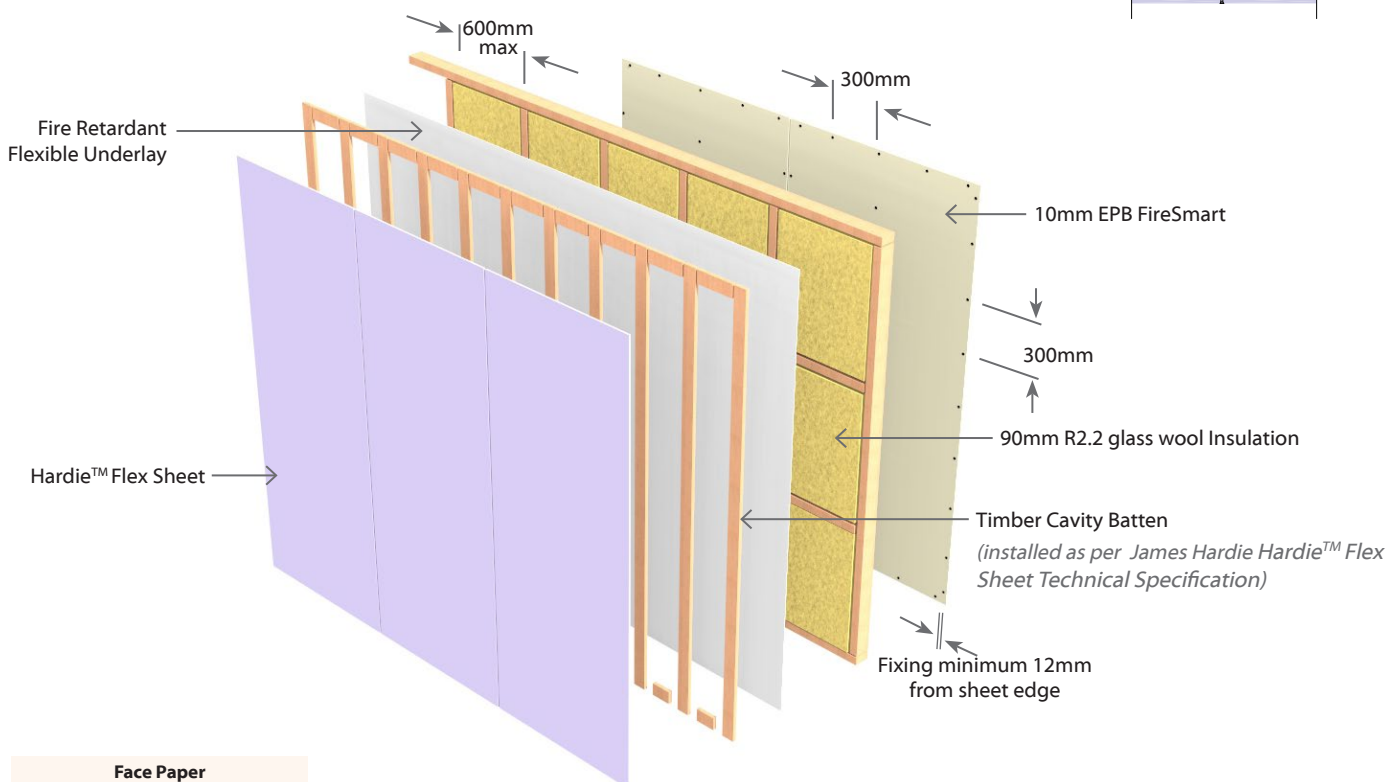
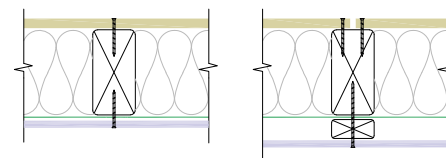

Face Paper	Product Identification Code
10mm EPB FireSmart	F10

N.B. The above drawings are for illustrative purposes only.



EJF1TL60 EPB & James Hardie Hardie™ Flex Sheet Two Way FRR

External Wall - Timber Frame Load Bearing

System Number	Lining Suffix	FRR	Insulation	Noise Control STC	Lining Requirement
EJF1TL60	-M13	60/60/60	Hardie™ Mineral	43	1 x 13mm EPB MultiSmart on Internal side James Hardie Hardie™ Flex Sheet to External side

Framing, Wall Height, Load and Framing Dimension

Timber framing to comply with relevant sections and clauses of NZBC B1: Structure and NZBC B2: Durability. Timber framing must be in accordance with NZS3604 stud tables for load bearing or non-load bearing partitions. Furthermore;

- Minimum framing dimension is 90 x 45mm.
- Nogs must be in place at a maximum of 800mm centres.
- Maximum stud spacing's are 600mm centres.
- The fire rated walls built close to boundary are also required to achieve post fire stability in either direction in accordance with the NZBC verification method B1/VM1, paragraph 2.2.4 Refer to latest James Hardie Fire & Acoustic Design Manual figures and tables for further detail.

Underlay

Fire Retardant Flexible Underlay

Install any Fire Retardant Flexible Underlay beneath the claddings, that complies with Table 23 of E2/AS1 and has a flammability index not exceeding 5.

Cavity Batten

When Cavity Batten is required, use a nominal 20mm Timber Cavity Batten. Refer to James Hardie Hardie™ Flex Sheet Technical Specification.

When Cladding can be directly fixed without a cavity batten then a fire retardant flexible underlay must be used.

James Hardie Hardie™ Flex Sheet Cladding

James Hardie Hardie™ Flex Sheet cladding to external side of the timber framing. Consider the nail length required depending on the type of fixing i.e. Cavity fixing or Direct fixing. Refer to both James Hardie Hardie™ Flex Sheet Technical Specification AND the James Hardie Fire & Acoustic Design Manual for information regarding fixing and finishing.

Wall Insulation

Insulation must be installed between studs and nogs. Use Hardie™ Mineral insulation.

EPB Plasterboard Lining

NB: The installer must look for the Product Identification Code on the face paper to ensure the correct board type is installed. Refer to the Face Paper Product Identification Code table on this page.

One layer of 13mm EPB MultiSmart lining to internal side of framing. Vertical fixing only permitted. Use full height sheets where possible when fixing vertical. All sheet joints must be fixed over solid timber framing. Sheets shall be touch fitted.

Fixing of EPB Plasterboard Internal Linings

Fasteners

41mm x 6g High Thread Drywall Screws

Fastener Centres

Fix at 300mm centres around sheet perimeter and up all intermediate studs. Place fasteners 50mm from sheet corners along the top and bottom plates. On end studs place additional fasteners 50-60mm vertically and no close than 10mm from plate to stud connections.

Place fasteners no closer than 12mm from the sheet edges and 18mm from sheet ends. Place fasteners at 200mm centres where sheet end butt joints occur.

Jointing and Finishing of EPB Plasterboard

All fastener heads stopped and all sheet joints reinforced with paper jointing tape and stopped. All in accordance with Elephant Plasterboard Installation Guide.

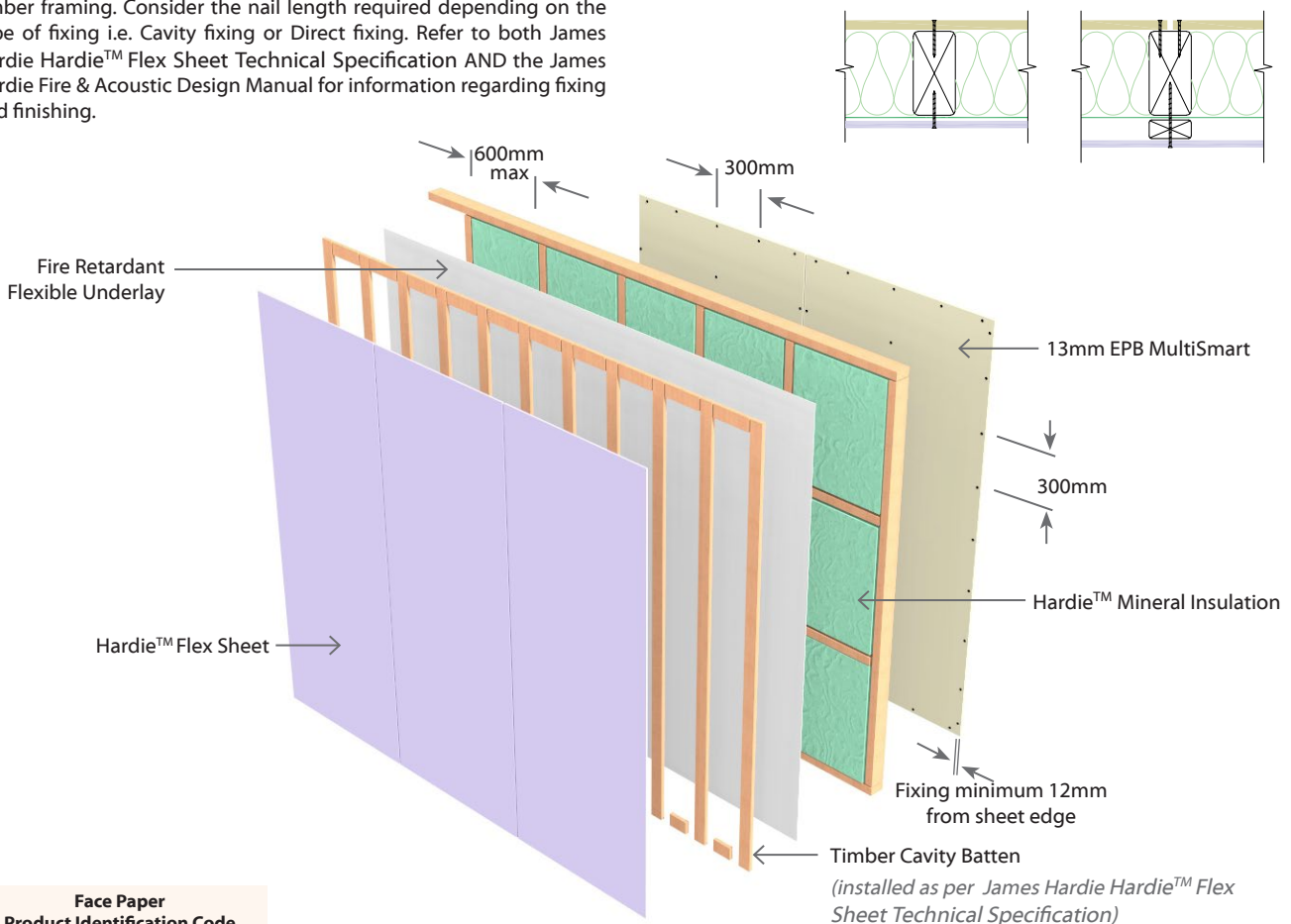

Face Paper Product Identification Code
13mm EPB MultiSmart M13

N.B. The above drawings are for illustrative purposes only.



EJA1TL30

EPB & James Hardie Axon™ Panel

Two Way FRR

External Wall - Timber Frame

Load Bearing

System Number	Lining Suffix	FRR	Insulation	Noise Control STC	Lining Requirement
EJA1TL30	-F10	30/30/30	R2.2 glass wool	41	1 x 10mm EPB FireSmart on Internal side James Hardie Axon™ Panel to External side

Framing, Wall Height, Load and Framing Dimension

Timber framing to comply with relevant sections and clauses of NZBC B1: Structure and NZBC B2: Durability. Timber framing must be in accordance with NZS3604 stud tables for load bearing or non-load bearing partitions. Furthermore;

- Minimum framing dimension is 90 x 45mm.
 - Nogs must be in place at a maximum of 800mm centres.
 - Maximum stud spacing's are 600mm centres.
 - The fire rated walls built close to boundary are also required to achieve post fire stability in either direction in accordance with the NZBC verification method B1/VM1, paragraph 2.2.4
- Refer to latest James Hardie Fire & Acoustic Design Manual figures and tables for further detail.

Underlay

For the type of allowable underlay refer to table below.

	EH Wind Zone	Other Wind Zone
Buildings <10m	RAB	Flexible Underlay
Buildings >10m	RAB	RAB

Fire Retardant Flexible Underlay

Install any Fire Retardant Flexible Underlay beneath the claddings, that complies with Table 23 of E2/AS1 and has a flammability index not exceeding 5.

RAB™ Board

One layer of James Hardie RAB™ Board fixed to entire framing.

6mm RAB™ Board : Use 40 x 2.8mm fibre cement nail at 200mm centres

9mm RAB™ Board : Use 50 x 2.8mm fibre cement nail at 200mm centres

Fixing to be 12mm from sheet edges

Reference to be made to the James Hardie Home RAB™ Pre-Cladding & RAB™ Board Installation Manual.

Cavity Batten

When Cavity Batten is required, use a nominal 20mm Timber Cavity Batten. Refer to Axon™ Panel Timber Cavity Batten Technical Specification. When Cladding is allowed to be directly fixed without a cavity batten then a fire retardant flexible underlay must be used. Refer to Axon™ Panel Direct Fixed Technical Specification.

James Hardie Axon™ Panel Cladding

James Hardie Axon™ Panel cladding to external side of the timber framing. Consider the nail length required depending on the type of fixing i.e. Cavity fixing or Direct fixing. Refer to both Axon™ Panel Timber Cavity Batten Technical Specification AND the James Hardie Fire & Acoustic Design Manual for information regarding fixing and finishing.

Wall Insulation

Insulation must be installed between studs and nogs. Use 90mm thick R2.2 glass wool insulation.

EPB Plasterboard Lining

NB: The installer must look for the Product Identification Code on the face paper to ensure the correct board type is installed. Refer to the Face Paper Product Identification Code table on this page.

One layer of 10mm EPB FireSmart lining to internal side of framing. Vertical fixing only permitted. Use full height sheets where possible when fixing vertical. All sheet joints must be fixed over solid timber framing. Sheets shall be touch fitted.

Fixing of EPB Plasterboard Internal Linings

Fasteners

41mm x 6g High Thread Drywall Screws

Fastener Centres

Fix at 300mm centres around sheet perimeter and up all intermediate studs. Place fasteners 50mm from sheet corners along the top and bottom plates. On end studs place additional fasteners 50-60mm vertically and no closer than 10mm from plate to stud connections.

Place fasteners no closer than 12mm from the sheet edges and 18mm from sheet ends. Place fasteners at 200mm centres where sheet end butt joints occur.

Jointing and Finishing of EPB Plasterboard

All fastener heads stopped and all sheet joints reinforced with paper jointing tape and stopped. All in accordance with Elephant Plasterboard Installation Guide.

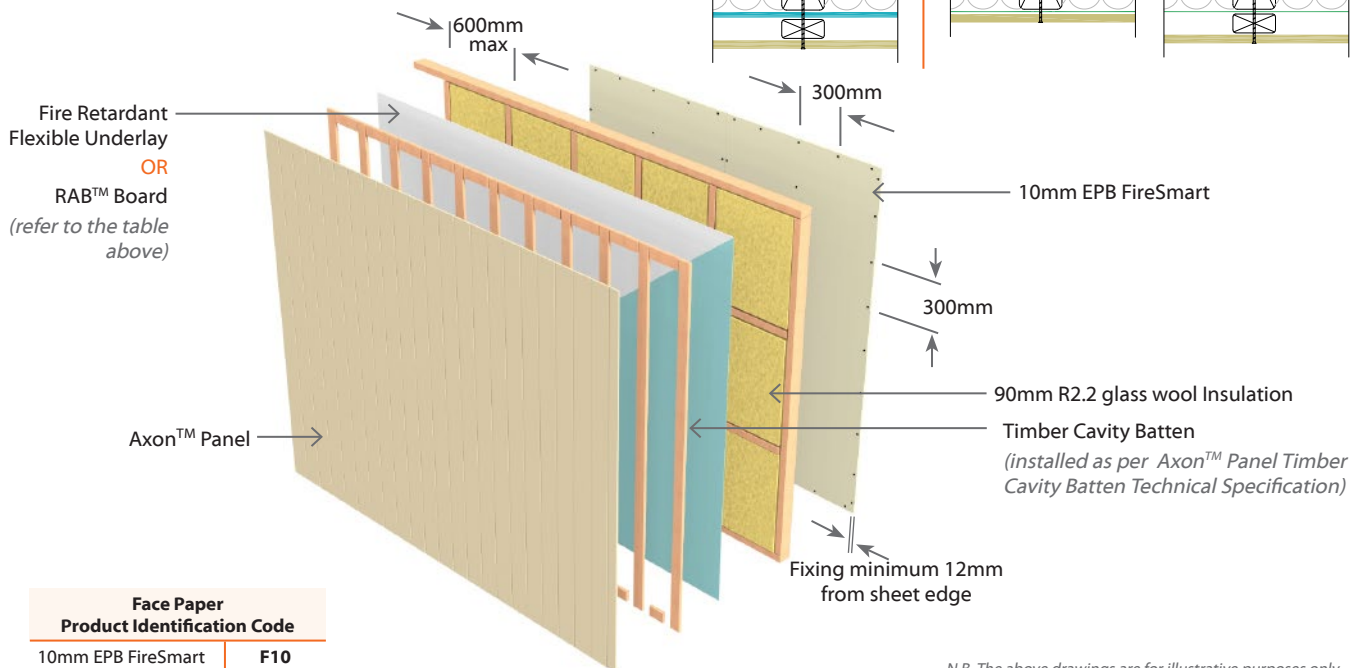

Face Paper Product Identification Code
10mm EPB FireSmart F10

N.B. The above drawings are for illustrative purposes only.



EJA1TL60

EPB & James Hardie Axon™ Panel

Two Way FRR

External Wall - Timber Frame

Load Bearing

System Number	Lining Suffix	FRR	Insulation	Noise Control STC	Lining Requirement
EJA1TL60	-M13	60/60/60	Hardie™ Mineral	42	1 x 13mm EPB MultiSmart on Internal side James Hardie Axon™ Panel to External side

Framing, Wall Height, Load and Framing Dimension

Timber framing to comply with relevant sections and clauses of NZBC B1: Structure and NZBC B2: Durability. Timber framing must be in accordance with NZS3604 stud tables for load bearing or non-load bearing partitions. Furthermore;

- Minimum framing dimension is 90 x 45mm.
 - Nogs must be in place at a maximum of 800mm centres.
 - Maximum stud spacing's are 600mm centres.
 - The fire rated walls built close to boundary are also required to achieve post fire stability in either direction in accordance with the NZBC verification method B1/VM1, paragraph 2.2.4
- Refer to latest James Hardie Fire & Acoustic Design Manual figures and tables for further detail.

Underlay

For the type of allowable underlay refer to table below.

	EH Wind Zone	Other Wind Zone
Buildings <10m	RAB	Flexible Underlay
Buildings >10m	RAB	RAB

Fire Retardant Flexible Underlay

Install any Fire Retardant Flexible Underlay beneath the claddings, that complies with Table 23 of E2/AS1 and has a flammability index not exceeding 5.

RAB™ Board

One layer of James Hardie RAB™ Board fixed to entire framing.
 6mm RAB™ Board : Use 40 x 2.8mm fibre cement nail at 200mm centres
 9mm RAB™ Board : Use 50 x 2.8mm fibre cement nail at 200mm centres
 Fixing to be 12mm from sheet edges
 Reference to be made to the James Hardie Home RAB™ Pre-Cladding & RAB™ Board Installation Manual.

Cavity Batten

When Cavity Batten is required, use a nominal 20mm Timber Cavity Batten. Refer to Axon™ Panel Timber Cavity Batten Technical Specification. When Cladding is allowed to be directly fixed without a cavity batten then a fire retardant flexible underlay must be used. Refer to Axon™ Panel Direct Fixed Technical Specification.

James Hardie Axon™ Panel Cladding

James Hardie Axon™ Panel cladding to external side of the timber framing. Consider the nail length required depending on the type of fixing i.e. Cavity fixing or Direct fixing. Refer to both Axon™ Panel Timber Cavity Batten Technical Specification AND the James Hardie Fire & Acoustic Design Manual for information regarding fixing and finishing.

Wall Insulation

Insulation must be installed between studs and nogs. Use Hardie™ Mineral insulation.

EPB Plasterboard Lining

NB: The installer must look for the Product Identification Code on the face paper to ensure the correct board type is installed. Refer to the Face Paper Product Identification Code table on this page.

One layer of 13mm EPB MultiSmart lining to internal side of framing. Vertical fixing only permitted. Use full height sheets where possible when fixing vertical. All sheet joints must be fixed over solid timber framing. Sheets shall be touch fitted.

Fixing of EPB Plasterboard Internal Linings

Fasteners

41mm x 6g High Thread Drywall Screws

Fastener Centres

Fix at 300mm centres around sheet perimeter and up all intermediate studs. Place fasteners 50mm from sheet corners along the top and bottom plates. On end studs place additional fasteners 50-60mm vertically and no closer than 10mm from plate to stud connections. Place fasteners no closer than 12mm from the sheet edges and 18mm from sheet ends. Place fasteners at 200mm centres where sheet end butt joints occur.

Jointing and Finishing of EPB Plasterboard

All fastener heads stopped and all sheet joints reinforced with paper jointing tape and stopped. All in accordance with Elephant Plasterboard Installation Guide.

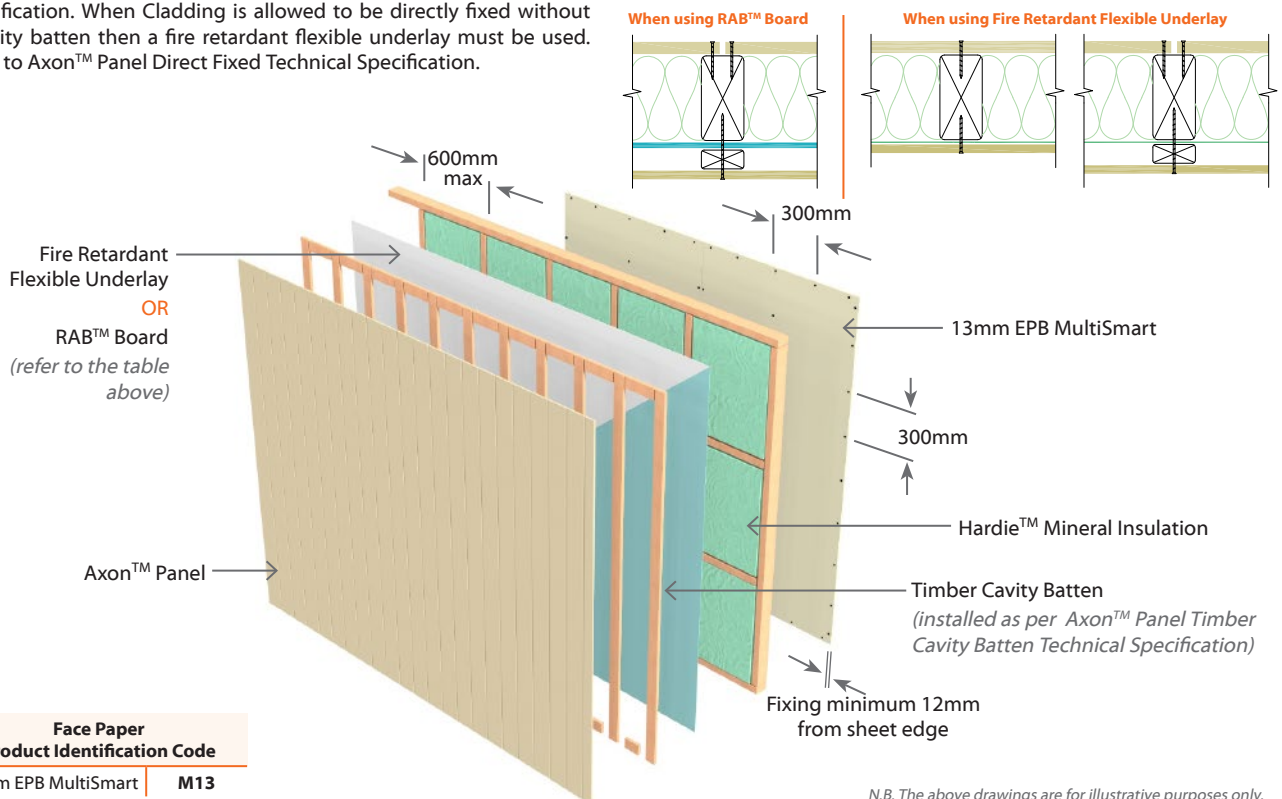

Face Paper Product Identification Code
13mm EPB MultiSmart M13

N.B. The above drawings are for illustrative purposes only.



EJRA1TL30

EPB & James Hardie Axon™ Panel & RAB™ Board on CLD™ Battens

Two Way FRR

External Wall - Timber Frame

Load Bearing

System Number	Lining Suffix	FRR	Insulation	Noise Control STC	Lining Requirement
EJRA1TL30	-F10	30/30/30	R2.2 glass wool	45	1 x 10mm EPB FireSmart on Internal side James Hardie Axon™ Panel and RAB™ Board with CLD™ Structural Cavity Batten to External side

Framing, Wall Height, Load and Framing Dimension

Timber framing to comply with relevant sections and clauses of NZBC B1: Structure and NZBC B2: Durability. Timber framing must be in accordance with NZS3604 stud tables for load bearing or non-load bearing partitions. Furthermore;

- Minimum framing dimension is 90 x 45mm.
- Nogs must be in place at a maximum of 800mm centres.
- Maximum stud spacing's are 600mm centres.
- The fire rated walls built close to boundary are also required to achieve post fire stability in either direction in accordance with the NZBC verification method B1/VM1, paragraph 2.2.4
Refer to latest James Hardie Fire & Acoustic Design Manual figures and tables for further detail.

Underlay

RAB™ Board

One layer of James Hardie RAB™ Board fixed to entire framing.
6mm RAB™ Board : Use 40 x 2.8mm fibre cement nail at 150mm centres
9mm RAB™ Board : Use 50 x 2.8mm fibre cement nail at 150mm centres
Fixing to be 12mm from sheet edges
Reference to be made to the James Hardie Home RAB™ Pre-Cladding & RAB™ Board Installation Manual.

Cavity Batten

Use 70 x 19mm CLD™ Structural Cavity Batten. Refer to Axon™ Panel CLD Structural Cavity Batten Technical Specification.

James Hardie Axon™ Panel Cladding

James Hardie Axon™ Panel cladding to external side of the timber framing. Refer to both Axon™ Panel CLD Structural Cavity Batten Technical Specification AND the James Hardie Fire & Acoustic Design Manual for information regarding fixing and finishing.

Wall Insulation

Insulation must be installed between studs and nogs. Use 90mm thick R2.2 glass wool insulation.

EPB Plasterboard Lining

NB: The installer must look for the Product Identification Code on the face paper to ensure the correct board type is installed. Refer to the Face Paper Product Identification Code table on this page.

One layer of 10mm EPB FireSmart lining to internal side of framing. Vertical fixing only permitted. Use full height sheets where possible when fixing vertical. All sheet joints must be fixed over solid timber framing. Sheets shall be touch fitted.

Fixing of EPB Plasterboard Internal Linings

Fasteners

41mm x 6g High Thread Drywall Screws

Fastener Centres

Fix at 300mm centres around sheet perimeter and up all intermediate studs. Place fasteners 50mm from sheet corners along the top and bottom plates. On end studs place additional fasteners 50-60mm vertically and no close than 10mm from plate to stud connections.

Place fasteners no closer than 12mm from the sheet edges and 18mm from sheet ends. Place fasteners at 200mm centres where sheet end butt joints occur.

Jointing and Finishing of EPB Plasterboard

All fastener heads stopped and all sheet joints reinforced with paper jointing tape and stopped. All in accordance with Elephant Plasterboard Installation Guide.

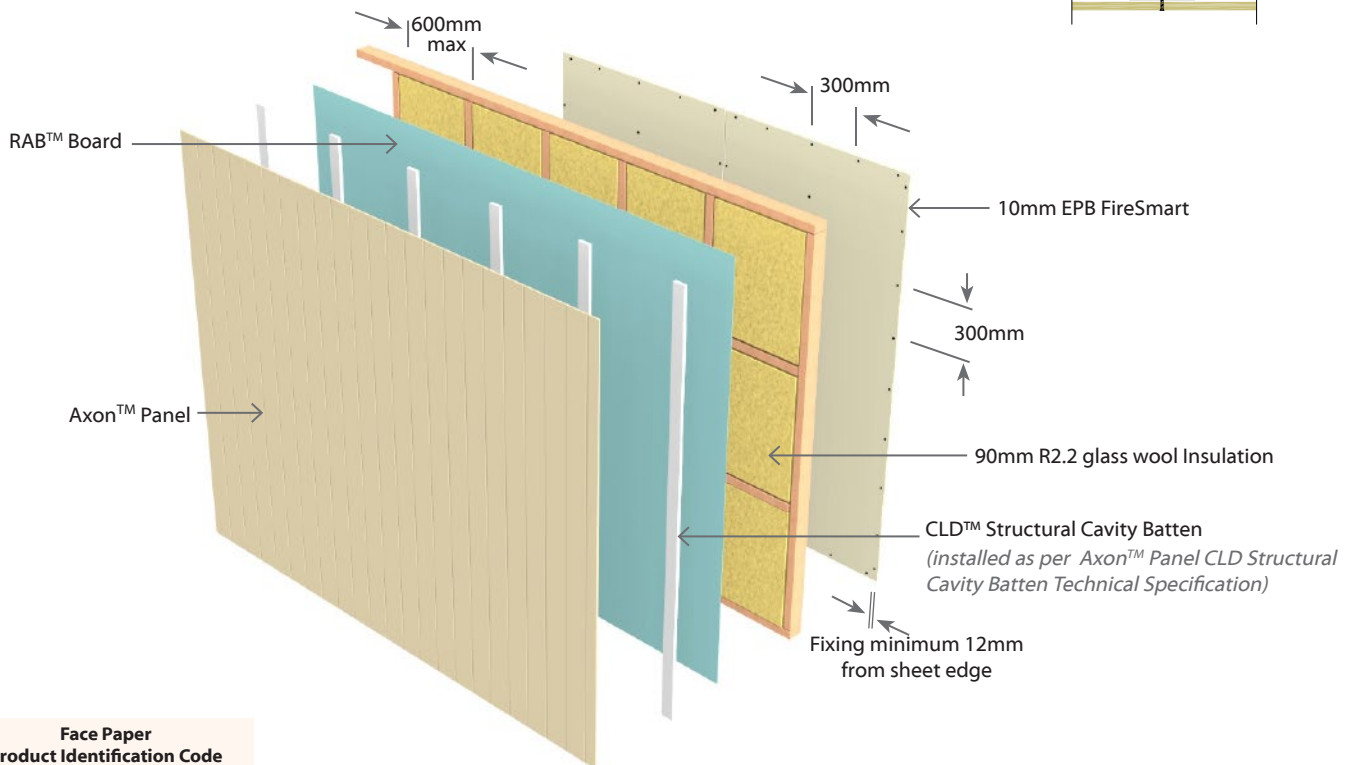
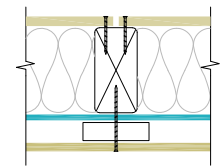

Face Paper Product Identification Code
10mm EPB FireSmart F10

N.B. The above drawings are for illustrative purposes only.



EJRA1TL60 EPB & James Hardie Axon™ Panel & RAB™ Board on CLD™ Battens | Two Way FRR

External Wall - Timber Frame | Load Bearing

System Number	Lining Suffix	FRR	Insulation	Noise Control STC	Lining Requirement
EJRA1TL60	-M13	60/60/60	Hardie™ Mineral	46	1 x 13mm EPB MultiSmart on Internal side James Hardie Axon™ Panel and RAB™ Board with CLD™ Structural Cavity Batten to External side

Framing, Wall Height, Load and Framing Dimension

Timber framing to comply with relevant sections and clauses of NZBC B1: Structure and NZBC B2: Durability. Timber framing must be in accordance with NZS3604 stud tables for load bearing or non-load bearing partitions. Furthermore;

- Minimum framing dimension is 90 x 45mm.
 - Nogs must be in place at a maximum of 800mm centres.
 - Maximum stud spacing's are 600mm centres.
 - The fire rated walls built close to boundary are also required to achieve post fire stability in either direction in accordance with the NZBC verification method B1/VM1, paragraph 2.2.4
- Refer to latest James Hardie Fire & Acoustic Design Manual figures and tables for further detail.

Underlay

RAB™ Board

One layer of James Hardie RAB™ Board fixed to entire framing.
 6mm RAB™ Board : Use 40 x 2.8mm fibre cement nail at 150mm centres
 9mm RAB™ Board : Use 50 x 2.8mm fibre cement nail at 150mm centres
 Fixing to be 12mm from sheet edges
 Reference to be made to the James Hardie Home RAB™ Pre-Cladding & RAB™ Board Installation Manual.

Cavity Batten

Use 70 x 19mm CLD™ Structural Cavity Batten. Refer to Axon™ Panel CLD Structural Cavity Batten Technical Specification.

James Hardie Axon™ Panel Cladding

James Hardie Axon™ Panel cladding to external side of the timber framing. Refer to both Axon™ Panel CLD Structural Cavity Batten Technical Specification AND the James Hardie Fire & Acoustic Design Manual for information regarding fixing and finishing.

Wall Insulation

Insulation must be installed between studs and nogs. Use Hardie™ Mineral insulation.

EPB Plasterboard Lining

NB: The installer must look for the Product Identification Code on the face paper to ensure the correct board type is installed. Refer to the Face Paper Product Identification Code table on this page.

One layer of 13mm EPB MultiSmart lining to internal side of framing. Vertical fixing only permitted. Use full height sheets where possible when fixing vertical. All sheet joints must be fixed over solid timber framing. Sheets shall be touch fitted.

Fixing of EPB Plasterboard Internal Linings

Fasteners

41mm x 6g High Thread Drywall Screws

Fastener Centres

Fix at 300mm centres around sheet perimeter and up all intermediate studs. Place fasteners 50mm from sheet corners along the top and bottom plates. On end studs place additional fasteners 50-60mm vertically and no close than 10mm from plate to stud connections. Place fasteners no closer than 12mm from the sheet edges and 18mm from sheet ends. Place fasteners at 200mm centres where sheet end butt joints occur.

Jointing and Finishing of EPB Plasterboard

All fastener heads stopped and all sheet joints reinforced with paper jointing tape and stopped. All in accordance with Elephant Plasterboard Installation Guide.

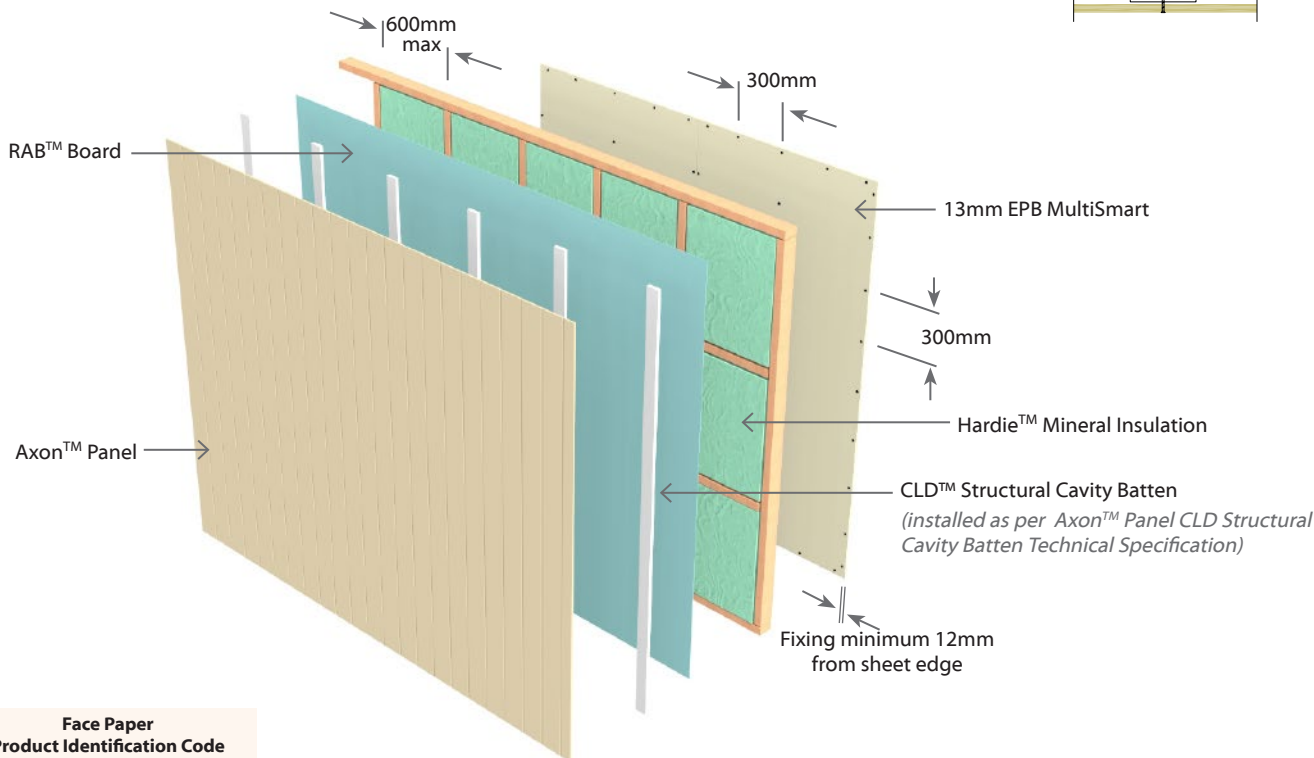
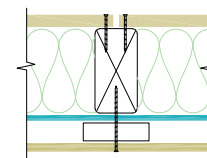

Face Paper	Product Identification Code
13mm EPB MultiSmart	M13

N.B. The above drawings are for illustrative purposes only.



EJE1TL30

EPB & James Hardie EasyLap™ Panel

Two Way FRR

External Wall - Timber Frame

Load Bearing

System Number	Lining Suffix	FRR	Insulation	Noise Control STC	Lining Requirement
EJE1TL30	-F10	30/30/30	R2.2 glass wool	42	1 x 10mm EPB FireSmart on Internal side James Hardie EasyLap™ Panel to External side

Framing, Wall Height, Load and Framing Dimension

Timber framing to comply with relevant sections and clauses of NZBC B1: Structure and NZBC B2: Durability. Timber framing must be in accordance with NZS3604 stud tables for load bearing or non-load bearing partitions. Furthermore;

- Minimum framing dimension is 90 x 45mm.
- Nogs must be in place at a maximum of 800mm centres.
- Maximum stud spacing's are 600mm centres.
- The fire rated walls built close to boundary are also required to achieve post fire stability in either direction in accordance with the NZBC verification method B1/VM1, paragraph 2.2.4 Refer to latest James Hardie Fire & Acoustic Design Manual figures and tables for further detail.

Underlay

For the type of allowable underlay refer to table below.

	EH Wind Zone	Other Wind Zone
Buildings <10m	RAB	Flexible Underlay
Buildings >10m	RAB	RAB

Fire Retardant Flexible Underlay

Install any Fire Retardant Flexible Underlay beneath the claddings, that complies with Table 23 of E2/AS1 and has a flammability index not exceeding 5.

RAB™ Board

One layer of James Hardie RAB™ Board fixed to entire framing.
6mm RAB™ Board : Use 40 x 2.8mm fibre cement nail at 200mm centres
9mm RAB™ Board : Use 50 x 2.8mm fibre cement nail at 200mm centres
Fixing to be 12mm from sheet edges

Reference to be made to the James Hardie Home RAB™ Pre-Cladding & RAB™ Board Installation Manual.

Cavity Batten

When Cavity Batten is required, use a nominal 20mm Timber Cavity Batten. Refer to Axon™ Panel & EasyLap™ Panel Timber Cavity Batten Technical Specification for installation instructions.

James Hardie EasyLap™ Panel Cladding

James Hardie EasyLap™ Panel cladding to external side of the timber framing. Refer to both Axon™ Panel & EasyLap™ Panel Timber Cavity Batten Technical Specification AND the James Hardie Fire & Acoustic Design Manual for information regarding fixing and finishing.

Wall Insulation

Insulation must be installed between studs and nogs. Use 90mm thick R2.2 glass wool insulation.

EPB Plasterboard Lining

NB: The installer must look for the Product Identification Code on the face paper to ensure the correct board type is installed. Refer to the Face Paper Product Identification Code table on this page.

One layer of 10mm EPB FireSmart lining to internal side of framing. Vertical fixing only permitted. Use full height sheets where possible when fixing vertical. All sheet joints must be fixed over solid timber framing. Sheets shall be touch fitted.

Fixing of EPB Plasterboard Internal Linings

Fasteners

41mm x 6g High Thread Drywall Screws

Fastener Centres

Fix at 300mm centres around sheet perimeter and up all intermediate studs. Place fasteners 50mm from sheet corners along the top and bottom plates. On end studs place additional fasteners 50-60mm vertically and no close than 10mm from plate to stud connections.

Place fasteners no closer than 12mm from the sheet edges and 18mm from sheet ends. Place fasteners at 200mm centres where sheet end butt joints occur.

Jointing and Finishing of EPB Plasterboard

All fastener heads stopped and all sheet joints reinforced with paper jointing tape and stopped. All in accordance with Elephant Plasterboard Installation Guide.

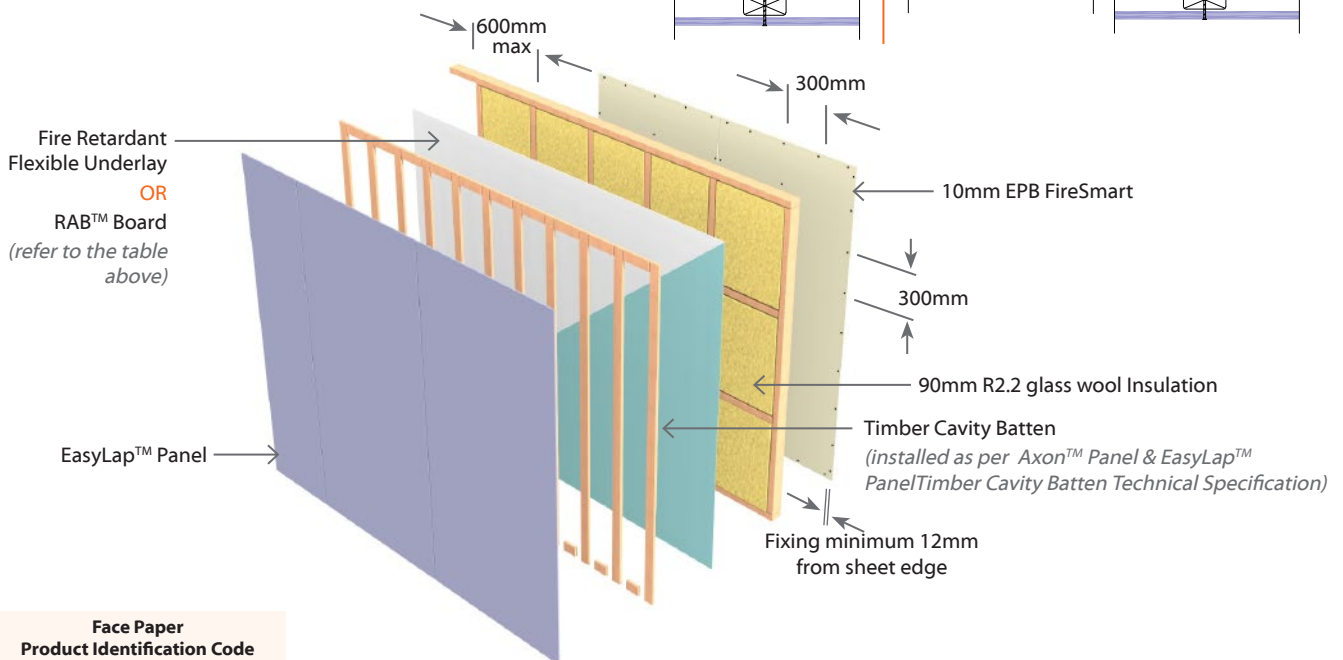

Face Paper Product Identification Code
10mm EPB FireSmart F10

N.B. The above drawings are for illustrative purposes only.



EJE1TL60 EPB & James Hardie EasyLap™ Panel Two Way FRR

External Wall - Timber Frame Load Bearing

System Number	Lining Suffix	FRR	Insulation	Noise Control STC	Lining Requirement
EJE1TL60	-M13	60/60/60	Hardie™ Mineral	43	1 x 13mm EPB MultiSmart on Internal side James Hardie EasyLap™ Panel to External side

Framing, Wall Height, Load and Framing Dimension

Timber framing to comply with relevant sections and clauses of NZBC B1: Structure and NZBC B2: Durability. Timber framing must be in accordance with NZS3604 stud tables for load bearing or non-load bearing partitions. Furthermore;

- Minimum framing dimension is 90 x 45mm.
- Nogs must be in place at a maximum of 800mm centres.
- Maximum stud spacing's are 600mm centres.
- The fire rated walls built close to boundary are also required to achieve post fire stability in either direction in accordance with the NZBC verification method B1/VM1, paragraph 2.2.4 Refer to latest James Hardie Fire & Acoustic Design Manual figures and tables for further detail.

Underlay

For the type of allowable underlay refer to table below.

	EH Wind Zone	Other Wind Zone
Buildings <10m	RAB	Flexible Underlay
Buildings >10m	RAB	RAB

Fire Retardant Flexible Underlay

Install any Fire Retardant Flexible Underlay beneath the claddings, that complies with Table 23 of E2/AS1 and has a flammability index not exceeding 5.

RAB™ Board

One layer of James Hardie RAB™ Board fixed to entire framing.
6mm RAB™ Board : Use 40 x 2.8mm fibre cement nail at 200mm centres
9mm RAB™ Board : Use 50 x 2.8mm fibre cement nail at 200mm centres
Fixing to be 12mm from sheet edges

Reference to be made to the James Hardie Home RAB™ Pre-Cladding & RAB™ Board Installation Manual.

Cavity Batten

When Cavity Batten is required, use a nominal 20mm Timber Cavity Batten. Refer to Axon™ Panel & EasyLap™ Panel Timber Cavity Batten Technical Specification for installation instructions.

James Hardie EasyLap™ Panel Cladding

James Hardie EasyLap™ Panel cladding to external side of the timber framing. Refer to both Axon™ Panel & EasyLap™ Panel Timber Cavity Batten Technical Specification AND the James Hardie Fire & Acoustic Design Manual for information regarding fixing and finishing.

Wall Insulation

Insulation must be installed between studs and nogs. Use Hardie™ Mineral insulation.

EPB Plasterboard Lining

NB: The installer must look for the Product Identification Code on the face paper to ensure the correct board type is installed. Refer to the Face Paper Product Identification Code table on this page.

One layer of 13mm EPB MultiSmart lining to internal side of framing. Vertical fixing only permitted. Use full height sheets where possible when fixing vertical. All sheet joints must be fixed over solid timber framing. Sheets shall be touch fitted.

Fixing of EPB Plasterboard Internal Linings

Fasteners

41mm x 6g High Thread Drywall Screws

Fastener Centres

Fix at 300mm centres around sheet perimeter and up all intermediate studs. Place fasteners 50mm from sheet corners along the top and bottom plates. On end studs place additional fasteners 50-60mm vertically and no close than 10mm from plate to stud connections.

Place fasteners no closer than 12mm from the sheet edges and 18mm from sheet ends. Place fasteners at 200mm centres where sheet end butt joints occur.

Jointing and Finishing of EPB Plasterboard

All fastener heads stopped and all sheet joints reinforced with paper jointing tape and stopped. All in accordance with Elephant Plasterboard Installation Guide.

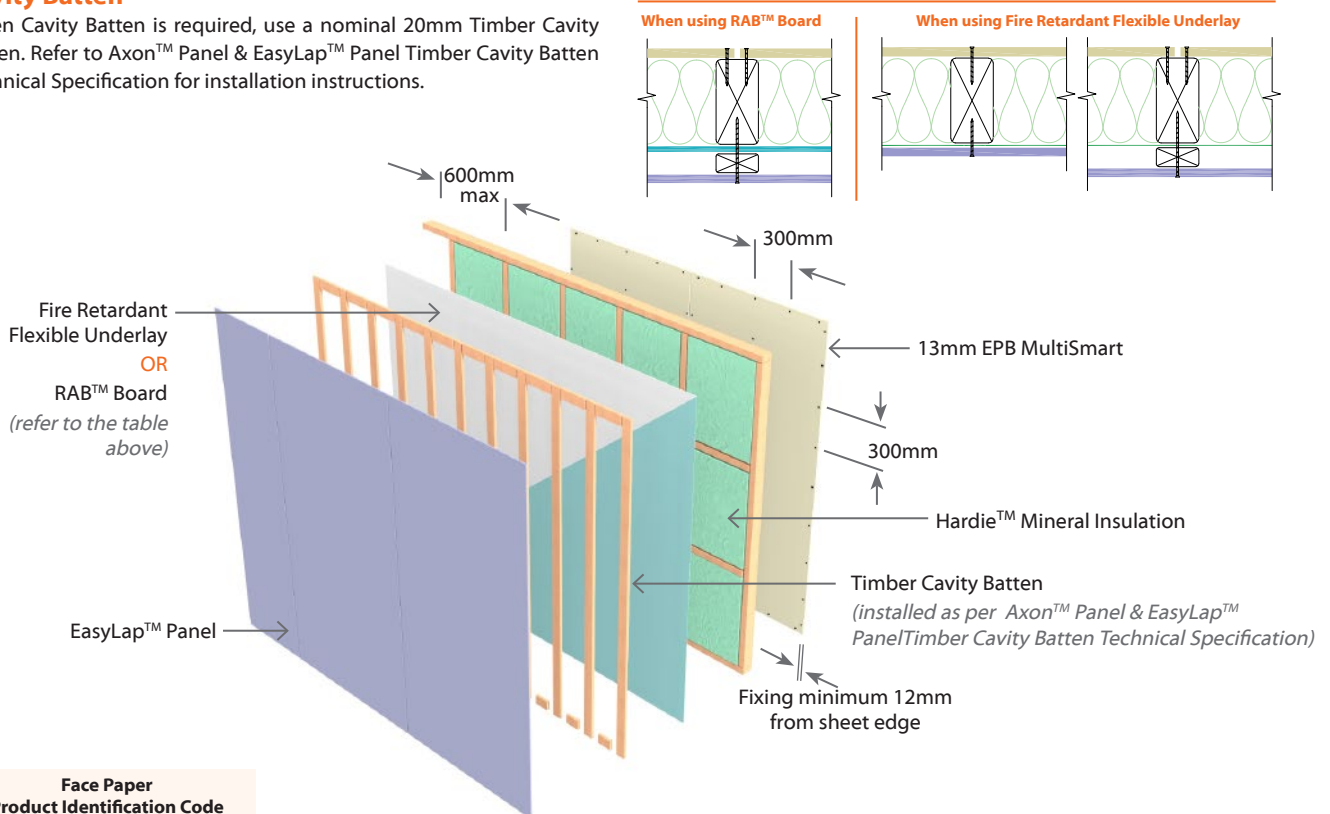

Face Paper Product Identification Code
13mm EPB MultiSmart M13

N.B. The above drawings are for illustrative purposes only.



EJRE1TL30

EPB & James Hardie EasyLap™ Panel & RAB™ Board with CLD™ Battens

Two Way FRR

External Wall - Timber Frame

Load Bearing

System Number	Lining Suffix	FRR	Insulation	Noise Control STC	Lining Requirement
EJRE1TL30	-F10	30/30/30	R2.2 glass wool	46	1 x 10mm EPB FireSmart on Internal side James Hardie EasyLap™ Panel and RAB™ Board with CLD™ Structural Cavity Batten to External side

Framing, Wall Height, Load and Framing Dimension

Timber framing to comply with relevant sections and clauses of NZBC B1: Structure and NZBC B2: Durability. Timber framing must be in accordance with NZS3604 stud tables for load bearing or non-load bearing partitions. Furthermore;

- Minimum framing dimension is 90 x 45mm.
 - Nogs must be in place at a maximum of 800mm centres.
 - Maximum stud spacing's are 600mm centres.
 - The fire rated walls built close to boundary are also required to achieve post fire stability in either direction in accordance with the NZBC verification method B1/VM1, paragraph 2.2.4
- Refer to latest James Hardie Fire & Acoustic Design Manual figures and tables for further detail.

Underlay

RAB™ Board

One layer of James Hardie RAB™ Board fixed to entire framing.
6mm RAB™ Board : Use 40 x 2.8mm fibre cement nail at 150mm centres
9mm RAB™ Board : Use 50 x 2.8mm fibre cement nail at 150mm centres
Fixing to be 12mm from sheet edges
Reference to be made to the James Hardie Home RAB™ Pre-Cladding & RAB™ Board Installation Manual.

Cavity Batten

Use 70 x 19mm CLD™ Structural Cavity Batten. Refer to EasyLap™ Panel Technical Specification

James Hardie EasyLap™ Panel Cladding

James Hardie EasyLap™ Panel cladding to external side of the timber framing. Refer to both EasyLap™ Panel Technical Specification AND

the James Hardie Fire & Acoustic Design Manual for information regarding fixing and finishing.

Wall Insulation

Insulation must be installed between studs and nogs. Use 90mm thick R2.2 glass wool insulation.

EPB Plasterboard Lining

NB: The installer must look for the Product Identification Code on the face paper to ensure the correct board type is installed. Refer to the Face Paper Product Identification Code table on this page.

One layer of 10mm EPB FireSmart lining to internal side of framing. Vertical fixing only permitted. Use full height sheets where possible when fixing vertical. All sheet joints must be fixed over solid timber framing. Sheets shall be touch fitted.

Fixing of EPB Plasterboard Internal Linings

Fasteners

41mm x 6g High Thread Drywall Screws

Fastener Centres

Fix at 300mm centres around sheet perimeter and up all intermediate studs. Place fasteners 50mm from sheet corners along the top and bottom plates. On end studs place additional fasteners 50-60mm vertically and no close than 10mm from plate to stud connections. Place fasteners no closer than 12mm from the sheet edges and 18mm from sheet ends. Place fasteners at 200mm centres where sheet end butt joints occur.

Jointing and Finishing of EPB Plasterboard

All fastener heads stopped and all sheet joints reinforced with paper jointing tape and stopped. All in accordance with Elephant Plasterboard Installation Guide.

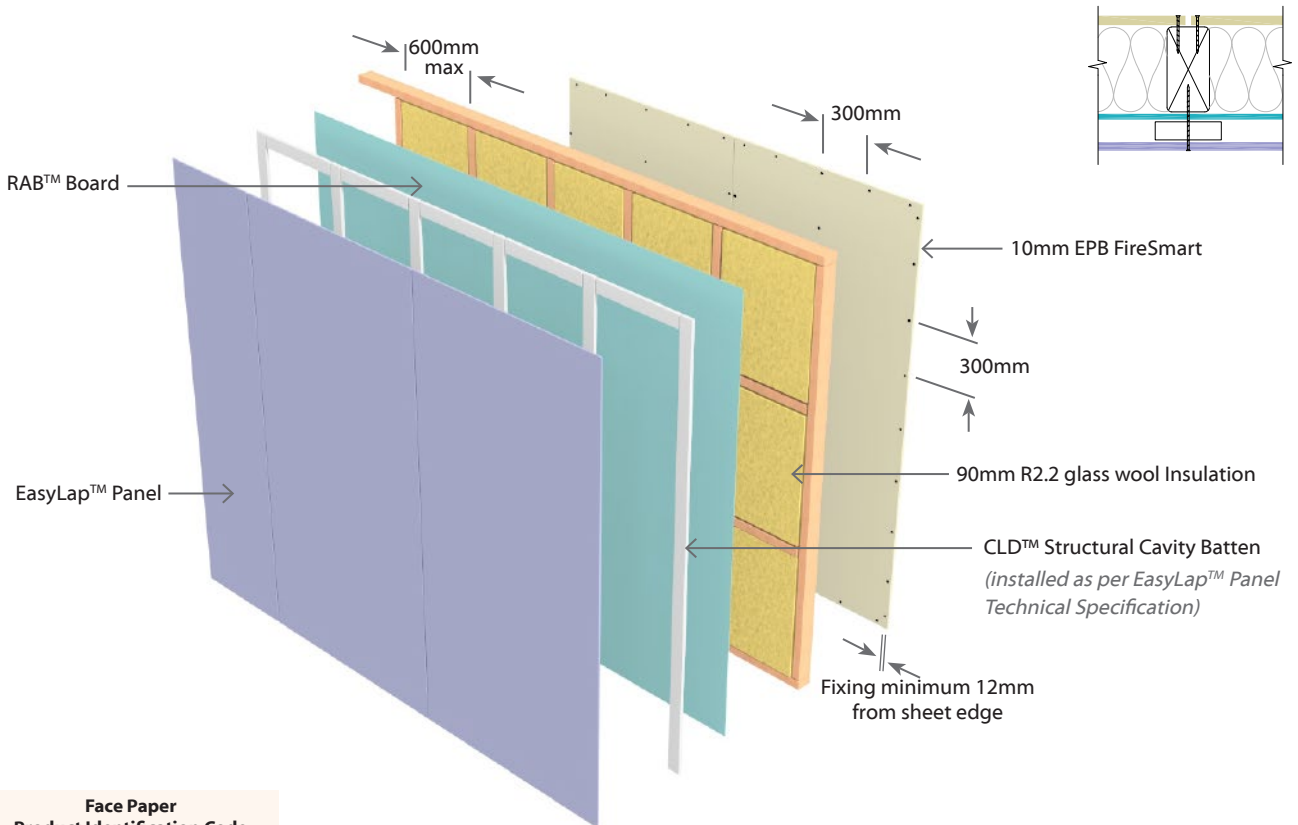

Face Paper Product Identification Code
10mm EPB FireSmart F10

N.B. The above drawings are for illustrative purposes only.



EJRE1TL60 EPB & James Hardie EasyLap™ Panel & RAB™ Board with CLD™ Battens | Two Way FRR

External Wall - Timber Frame | Load Bearing

System Number	Lining Suffix	FRR	Insulation	Noise Control STC	Lining Requirement
EJRE1TL60	-M13	60/60/60	Hardie™ Mineral	47	1 x 13mm EPB MultiSmart on Internal side James Hardie EasyLap™ Panel and RAB™ Board with CLD™ Structural Cavity Batten to External side

Framing, Wall Height, Load and Framing Dimension

Timber framing to comply with relevant sections and clauses of NZBC B1: Structure and NZBC B2: Durability. Timber framing must be in accordance with NZS3604 stud tables for load bearing or non-load bearing partitions. Furthermore;

- Minimum framing dimension is 90 x 45mm.
- Nogs must be in place at a maximum of 800mm centres.
- Maximum stud spacing's are 600mm centres.
- The fire rated walls built close to boundary are also required to achieve post fire stability in either direction in accordance with the NZBC verification method B1/VM1, paragraph 2.2.4 Refer to latest James Hardie Fire & Acoustic Design Manual figures and tables for further detail.

Underlay

RAB™ Board

One layer of James Hardie RAB™ Board fixed to entire framing.
6mm RAB™ Board : Use 40 x 2.8mm fibre cement nail at 150mm centres
9mm RAB™ Board : Use 50 x 2.8mm fibre cement nail at 150mm centres
Fixing to be 12mm from sheet edges
Reference to be made to the James Hardie Home RAB™ Pre-Cladding & RAB™ Board Installation Manual.

Cavity Batten

Use 70 x 19mm CLD™ Structural Cavity Batten. Refer to EasyLap™ Panel Technical Specification

James Hardie EasyLap™ Panel Cladding

James Hardie EasyLap™ Panel cladding to external side of the timber framing. Refer to both EasyLap™ Panel Technical Specification AND the James Hardie Fire & Acoustic Design Manual for information regarding fixing and finishing.

Wall Insulation

Insulation must be installed between studs and nogs. Use Hardie™ Mineral insulation.

EPB Plasterboard Lining

NB: The installer must look for the Product Identification Code on the face paper to ensure the correct board type is installed. Refer to the Face Paper Product Identification Code table on this page.

One layer of 13mm EPB MultiSmart lining to internal side of framing. Vertical fixing only permitted. Use full height sheets where possible when fixing vertical. All sheet joints must be fixed over solid timber framing. Sheets shall be touch fitted.

Fixing of EPB Plasterboard Internal Linings

Fasteners

41mm x 6g High Thread Drywall Screws

Fastener Centres

Fix at 300mm centres around sheet perimeter and up all intermediate studs. Place fasteners 50mm from sheet corners along the top and bottom plates. On end studs place additional fasteners 50-60mm vertically and no close than 10mm from plate to stud connections.

Place fasteners no closer than 12mm from the sheet edges and 18mm from sheet ends. Place fasteners at 200mm centres where sheet end butt joints occur.

Jointing and Finishing of EPB Plasterboard

All fastener heads stopped and all sheet joints reinforced with paper jointing tape and stopped. All in accordance with Elephant Plasterboard Installation Guide.

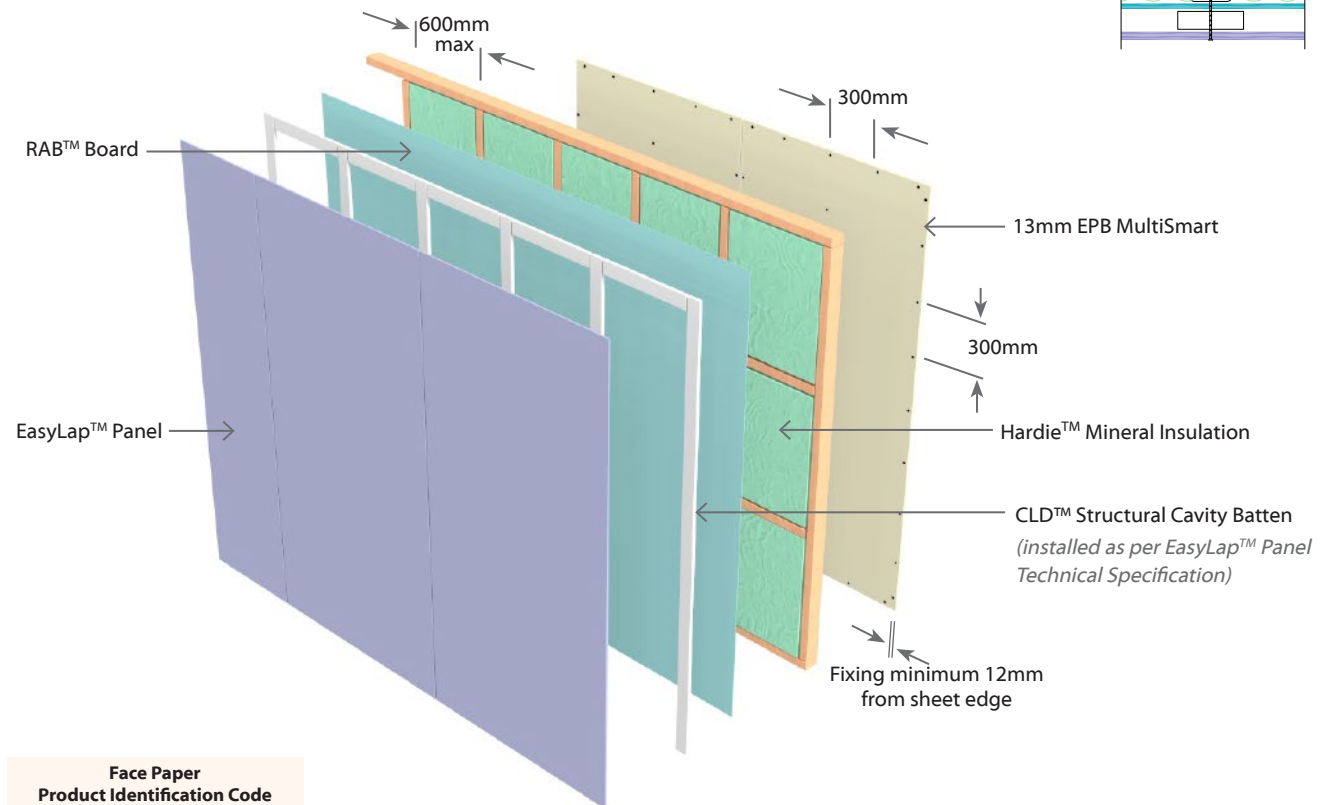

Face Paper Product Identification Code
13mm EPB MultiSmart M13

N.B. The above drawings are for illustrative purposes only.

EJR1TL30

EPB & JH ExoTec™ Facade Panel & RAB™ Board with Top Hat System

Two Way FRR

External Wall - Timber Frame

Load Bearing

System Number	Lining Suffix	FRR	Insulation	Noise Control STC	Lining Requirement
EJR1TL30	-F10	30/30/30	R2.2 glass wool	47	1 x 10mm EPB FireSmart on Internal side James Hardie ExoTec™ Facade Panel and RAB™ Board with Top hat system to External side

Framing, Wall Height, Load and Framing Dimension

Timber framing to comply with relevant sections and clauses of NZBC B1: Structure and NZBC B2: Durability. Timber framing must be in accordance with NZS3604 stud tables for load bearing or non-load bearing partitions. Furthermore;

- Minimum framing dimension is 90 x 45mm.
 - Nogs must be in place at a maximum of 800mm centres.
 - Maximum stud spacing's are 600mm centres.
 - The fire rated walls built close to boundary are also required to achieve post fire stability in either direction in accordance with the NZBC verification method B1/VM1, paragraph 2.2.4
- Refer to latest James Hardie Fire & Acoustic Design Manual figures and tables for further detail.

Underlay

RAB™ Board

One layer of James Hardie RAB™ Board fixed to entire framing.
6mm RAB™ Board : Use 40 x 2.8mm fibre cement nail at 150mm centres
9mm RAB™ Board : Use 50 x 2.8mm fibre cement nail at 150mm centres
Fixing to be 12mm from sheet edges
Reference to be made to the James Hardie Home RAB™ Pre-Cladding & RAB™ Board Installation Manual.

Cavity Batten

Use ExoTec™ Top hat system. Refer to ExoTec™ Facade Panel Top Hat Rainscreen Technical Specification

James Hardie ExoTec™ Facade Panel Cladding

James Hardie ExoTec™ Facade Panel cladding to external side of the timber framing. Refer to both ExoTec™ Facade Panel Top Hat Rainscreen Technical Specification AND the James Hardie Fire & Acoustic Design Manual for information regarding fixing and finishing.

Wall Insulation

Insulation must be installed between studs and nogs. Use 90mm thick R2.2 glass wool insulation.

EPB Plasterboard Lining

NB: The installer must look for the Product Identification Code on the face paper to ensure the correct board type is installed. Refer to the Face Paper Product Identification Code table on this page.

One layer of 10mm EPB FireSmart lining to internal side of framing. Vertical fixing only permitted. Use full height sheets where possible when fixing vertical. All sheet joints must be fixed over solid timber framing. Sheets shall be touch fitted.

Fixing of EPB Plasterboard Internal Linings

Fasteners

41mm x 6g High Thread Drywall Screws

Fastener Centres

Fix at 300mm centres around sheet perimeter and up all intermediate studs. Place fasteners 50mm from sheet corners along the top and bottom plates. On end studs place additional fasteners 50-60mm vertically and no close than 10mm from plate to stud connections.

Place fasteners no closer than 12mm from the sheet edges and 18mm from sheet ends. Place fasteners at 200mm centres where sheet end butt joints occur.

Jointing and Finishing of EPB Plasterboard

All fastener heads stopped and all sheet joints reinforced with paper jointing tape and stopped. All in accordance with Elephant Plasterboard Installation Guide.

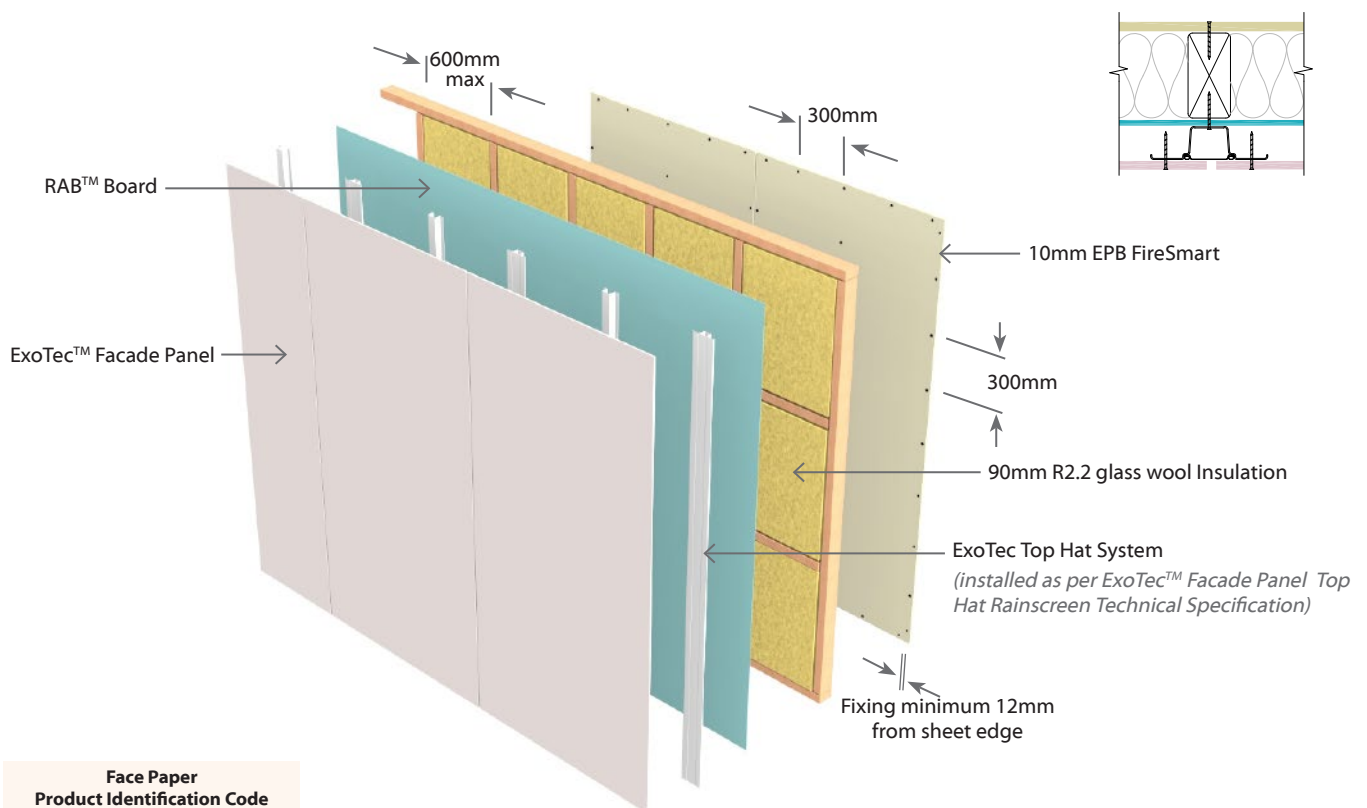

Face Paper Product Identification Code
10mm EPB FireSmart F10

N.B. The above drawings are for illustrative purposes only.



EJR1TL60 EPB & JH ExoTec™ Facade Panel & RAB™ Board with Top Hat System | Two Way FRR

External Wall - Timber Frame | Load Bearing

System Number	Lining Suffix	FRR	Insulation	Noise Control STC	Lining Requirement
EJR1TL60	-M13	60/60/60	Hardie™ Mineral	48	1 x 13mm EPB MultiSmart on Internal side James Hardie ExoTec™ Facade Panel and RAB™ Board with Top hat system to External side

Framing, Wall Height, Load and Framing Dimension

Timber framing to comply with relevant sections and clauses of NZBC B1: Structure and NZBC B2: Durability. Timber framing must be in accordance with NZS3604 stud tables for load bearing or non-load bearing partitions. Furthermore;

- Minimum framing dimension is 90 x 45mm.
 - Nogs must be in place at a maximum of 800mm centres.
 - Maximum stud spacing's are 600mm centres.
 - The fire rated walls built close to boundary are also required to achieve post fire stability in either direction in accordance with the NZBC verification method B1/VM1, paragraph 2.2.4
- Refer to latest James Hardie Fire & Acoustic Design Manual figures and tables for further detail.

Underlay

RAB™ Board

One layer of James Hardie RAB™ Board fixed to entire framing.
 6mm RAB™ Board : Use 40 x 2.8mm fibre cement nail at 150mm centres
 9mm RAB™ Board : Use 50 x 2.8mm fibre cement nail at 150mm centres
 Fixing to be 12mm from sheet edges
 Reference to be made to the James Hardie Home RAB™ Pre-Cladding & RAB™ Board Installation Manual.

Cavity Batten

Use ExoTec™ Top hat system. Refer to ExoTec™ Facade Panel Top Hat Rainscreen Technical Specification

James Hardie ExoTec™ Facade Panel Cladding

James Hardie ExoTec™ Facade Panel cladding to external side of the timber framing. Refer to both ExoTec™ Facade Panel Top Hat Rainscreen Technical Specification AND the James Hardie Fire & Acoustic Design Manual for information regarding fixing and finishing.

Wall Insulation

Insulation must be installed between studs and nogs. Use Hardie™ Mineral insulation.

EPB Plasterboard Lining

NB: The installer must look for the Product Identification Code on the face paper to ensure the correct board type is installed. Refer to the Face Paper Product Identification Code table on this page.

One layer of 13mm EPB MultiSmart lining to internal side of framing. Vertical fixing only permitted. Use full height sheets where possible when fixing vertical. All sheet joints must be fixed over solid timber framing. Sheets shall be touch fitted.

Fixing of EPB Plasterboard Internal Linings

Fasteners

41mm x 6g High Thread Drywall Screws

Fastener Centres

Fix at 300mm centres around sheet perimeter and up all intermediate studs. Place fasteners 50mm from sheet corners along the top and bottom plates. On end studs place additional fasteners 50-60mm vertically and no close than 10mm from plate to stud connections.

Place fasteners no closer than 12mm from the sheet edges and 18mm from sheet ends. Place fasteners at 200mm centres where sheet end butt joints occur.

Jointing and Finishing of EPB Plasterboard

All fastener heads stopped and all sheet joints reinforced with paper jointing tape and stopped. All in accordance with Elephant Plasterboard Installation Guide.

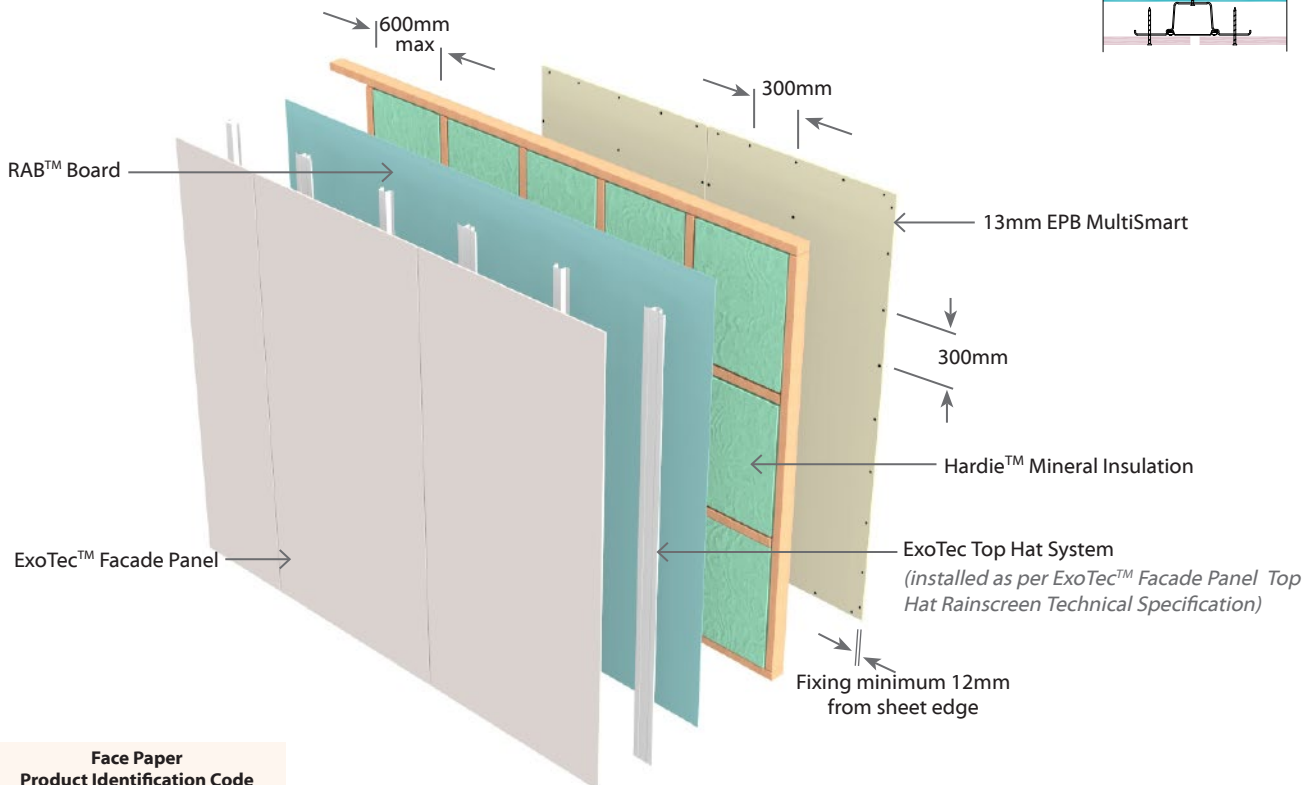
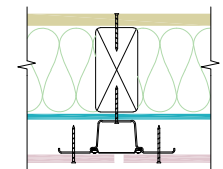

Face Paper Product Identification Code
13mm EPB MultiSmart M13

N.B. The above drawings are for illustrative purposes only.

EJRN1TL30

EPB & James Hardie RAB™ Board & a Weathertight Cladding

Two Way FRR

External Wall - Timber Frame

Load Bearing

System Number	Lining Suffix	FRR	Insulation	Noise Control STC	Lining Requirement
EJRN1TL30	-F10	30/30/30	R2.2 glass wool	42	1 x 10mm EPB FireSmart on Internal side James Hardie RAB™ Board with a Weathertight Cladding to External side

Framing, Wall Height, Load and Framing Dimension

Timber framing to comply with relevant sections and clauses of NZBC B1: Structure and NZBC B2: Durability. Timber framing must be in accordance with NZS3604 stud tables for load bearing or non-load bearing partitions. Furthermore;

- Minimum framing dimension is 90 x 45mm.
- Nogs must be in place at a maximum of 800mm centres.
- Maximum stud spacing's are 600mm centres.
- The fire rated walls built close to boundary are also required to achieve post fire stability in either direction in accordance with the NZBC verification method B1/VM1, paragraph 2.2.4

Refer to latest James Hardie Fire & Acoustic Design Manual figures and tables for further instructions.

Underlay

RAB™ Board

One layer of James Hardie RAB™ Board fixed to entire framing.

6mm RAB™ Board : Use 40 x 2.8mm fibre cement nail at 150mm centres

9mm RAB™ Board : Use 50 x 2.8mm fibre cement nail at 150mm centres

Fixing to be 12mm from sheet edges

Reference to be made to the James Hardie Home RAB™ Pre-Cladding & RAB™ Board Installation Manual.

Cavity Batten

Cavity battens as per cladding manufacturer's technical specification.

Weathertight Cladding

The Exterior wall must be clad with a suitable weathertight material. Cladding fixed as per manufacturer's technical specification.

N.B: It is important to consider the fire properties of the external cladding is in accordance with NZBC C/VM1 or C/AS documents.

Refer to Table 5.1 of Section 5.4 of C/AS1 and Table 5.5 of Section 5.8.1 of C/AS2 for the information about various risk groups to identify the external fire spread safety requirement applicable to the exterior surface finishes.

Wall Insulation

Insulation must be installed between studs and nogs. Use 90mm thick R2.2 glass wool insulation.

EPB Plasterboard Lining

NB: The installer must look for the Product Identification Code on the face paper to ensure the correct board type is installed. Refer to the Face Paper Product Identification Code table on this page.

One layer of 10mm EPB FireSmart lining to internal side of framing. Vertical fixing only permitted. Use full height sheets where possible when fixing vertical. All sheet joints must be fixed over solid timber framing. Sheets shall be touch fitted.

Fixing of EPB Plasterboard Internal Linings

Fasteners

41mm x 6g High Thread Drywall Screws

Fastener Centres

Fix at 300mm centres around sheet perimeter and up all intermediate studs. Place fasteners 50mm from sheet corners along the top and bottom plates. On end studs place additional fasteners 50-60mm vertically and no close than 10mm from plate to stud connections.

Place fasteners no closer than 12mm from the sheet edges and 18mm from sheet ends. Place fasteners at 200mm centres where sheet end butt joints occur.

Jointing and Finishing of EPB Plasterboard

All fastener heads stopped and all sheet joints reinforced with paper jointing tape and stopped. All in accordance with Elephant Plasterboard Installation Guide.

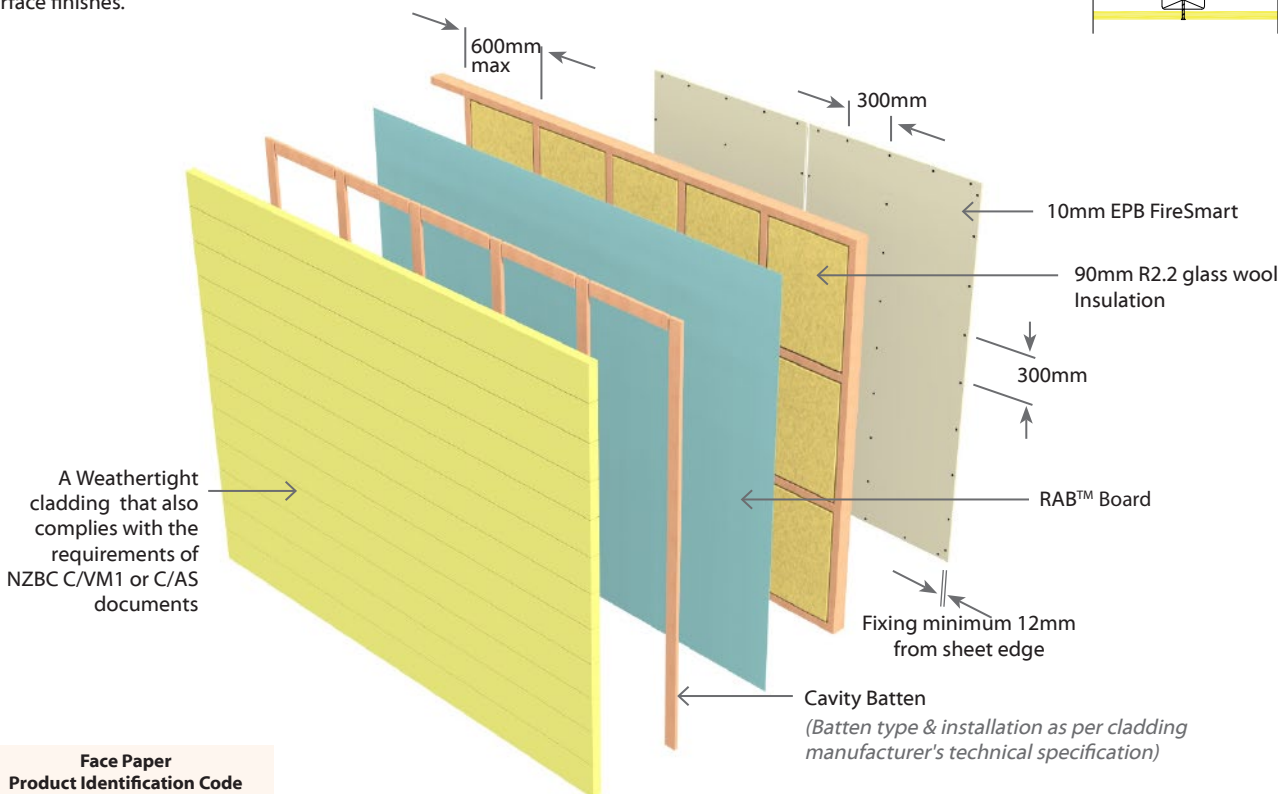
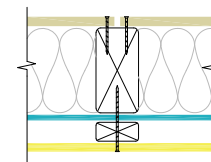

Face Paper Product Identification Code	F10
10mm EPB FireSmart	F10

N.B. The above drawings are for illustrative purposes only.



EJRN1TL60 EPB & James Hardie RAB™ Board & a Weathertight Cladding Two Way FRR

External Wall - Timber Frame Load Bearing

System Number	Lining Suffix	FRR	Insulation	Noise Control STC	Lining Requirement
EJRN1TL60	-M13	60/60/60	Hardie™ Mineral	42	1 x 13mm EPB MultiSmart on Internal side James Hardie RAB™ Board with a Weathertight Cladding to External side

Framing, Wall Height, Load and Framing Dimension

Timber framing to comply with relevant sections and clauses of NZBC B1: Structure and NZBC B2: Durability. Timber framing must be in accordance with NZS3604 stud tables for load bearing or non-load bearing partitions. Furthermore;

- Minimum framing dimension is 90 x 45mm.
- Nogs must be in place at a maximum of 800mm centres.
- Maximum stud spacing's are 600mm centres.
- The fire rated walls built close to boundary are also required to achieve post fire stability in either direction in accordance with the NZBC verification method B1/VM1, paragraph 2.2.4

Refer to latest James Hardie Fire & Acoustic Design Manual figures and tables for further instructions.

Underlay

RAB™ Board

One layer of James Hardie RAB™ Board fixed to entire framing.
6mm RAB™ Board : Use 40 x 2.8mm fibre cement nail at 150mm centres
9mm RAB™ Board : Use 50 x 2.8mm fibre cement nail at 150mm centres
Fixing to be 12mm from sheet edges

Reference to be made to the James Hardie Home RAB™ Pre-Cladding & RAB™ Board Installation Manual.

Cavity Batten

Cavity battens as per cladding manufacturer's technical specification.

Weathertight Cladding

The Exterior wall must be clad with a suitable weathertight material. Cladding fixed as per manufacturer's technical specification.

N.B: It is important to consider the fire properties of the external cladding is in accordance with NZBC C/VM1 or C/AS documents.

Refer to Table 5.1 of Section 5.4 of C/AS1 and Table 5.5 of Section 5.8.1 of C/AS2 for the information about various risk groups to identify the external fire spread safety requirement applicable to the exterior surface finishes.

Wall Insulation

Insulation must be installed between studs and nogs. Use Hardie™ Mineral insulation.

EPB Plasterboard Lining

NB: The installer must look for the Product Identification Code on the face paper to ensure the correct board type is installed. Refer to the Face Paper Product Identification Code table on this page.

One layer of 13mm EPB MultiSmart lining to internal side of framing. Vertical fixing only permitted. Use full height sheets where possible when fixing vertical. All sheet joints must be fixed over solid timber framing. Sheets shall be touch fitted.

Fixing of EPB Plasterboard Internal Linings

Fasteners

41mm x 6g High Thread Drywall Screws

Fastener Centres

Fix at 300mm centres around sheet perimeter and up all intermediate studs. Place fasteners 50mm from sheet corners along the top and bottom plates. On end studs place additional fasteners 50-60mm vertically and no close than 10mm from plate to stud connections.

Place fasteners no closer than 12mm from the sheet edges and 18mm from sheet ends. Place fasteners at 200mm centres where sheet end butt joints occur.

Jointing and Finishing of EPB Plasterboard

All fastener heads stopped and all sheet joints reinforced with paper jointing tape and stopped. All in accordance with Elephant Plasterboard Installation Guide.

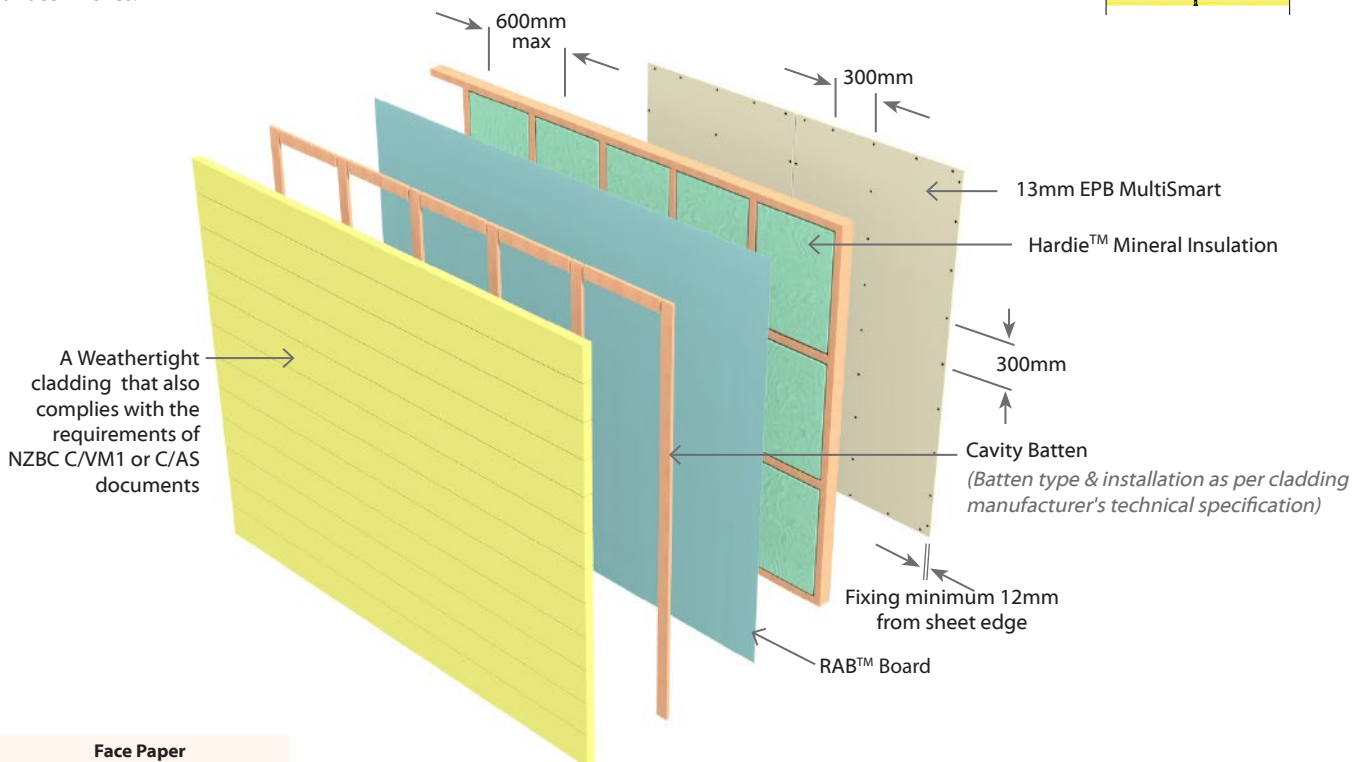
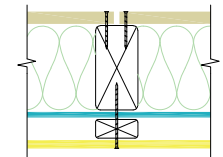

Face Paper Product Identification Code
13mm EPB MultiSmart M13

N.B. The above drawings are for illustrative purposes only.

EJRN2TL60

EPB & James Hardie RAB™ Board & a Weathertight Cladding

Two Way FRR

External Wall - Timber Frame

Load Bearing

System Number	Lining Suffix	FRR	Insulation	Noise Control STC	Lining Requirement
EJRN2TL60	-F20	60/60/60	Hardie™ Mineral	46	2 x 10mm EPB FireSmart on Internal side James Hardie RAB™ Board with a Weathertight Cladding to External side
	-S26	60/60/60	Hardie™ Mineral	47	2 x 13mm EPB Standard on Internal side James Hardie RAB™ Board with a Weathertight Cladding to External side
	-M20	60/60/60	Hardie™ Mineral	47	2 x 10mm EPB MultiSmart on Internal side James Hardie RAB™ Board with a Weathertight Cladding to External side

Framing, Wall Height, Load and Framing Dimension

Timber framing to comply with relevant sections and clauses of NZBC B1: Structure and NZBC B2: Durability. Timber framing must be in accordance with NZS3604 stud tables for load bearing or non-load bearing partitions. Furthermore;

- Minimum framing dimension is 90 x 45mm.
- Nogs must be in place at a maximum of 800mm centres.
- Maximum stud spacing's are 600mm centres.
- The fire rated walls built close to boundary are also required to achieve post fire stability in either direction in accordance with the NZBC verification method B1/VM1, paragraph 2.2.4

Refer to latest James Hardie Fire & Acoustic Design Manual figures and tables for further instructions.

Underlay

RAB™ Board

One layer of James Hardie RAB™ Board fixed to entire framing.

6mm RAB™ Board : Use 40 x 2.8mm fibre cement nail at 150mm centres

9mm RAB™ Board : Use 50 x 2.8mm fibre cement nail at 150mm centres

Fixing to be 12mm from sheet edges

Reference to be made to the James Hardie Home RAB™ Pre-Cladding & RAB™ Board Installation Manual.

Cavity Batten

Cavity battens as per cladding manufacturer's technical specification.

Weathertight Cladding

The Exterior wall must be clad with a suitable weathertight material. Cladding fixed as per manufacturer's technical specification.

N.B: It is important to consider the fire properties of the external cladding is in accordance with NZBC C/VM1 or C/AS documents.

Refer to Table 5.1 of Section 5.4 of C/AS1 and Table 5.5 of Section 5.8.1 of C/AS2 for the information about various risk groups to identify the external fire spread safety requirement applicable to the exterior surface finishes.

Wall Insulation

Insulation must be installed between studs and nogs. Use Hardie™ Mineral insulation.

EPB Plasterboard Lining

NB: The installer must look for the Product Identification Code on the face paper to ensure the correct board type is installed. Refer to the Face Paper Product Identification Code table on this page.

Two layers of EPB Plasterboard lining to internal side of framing as per specified system above. First layer or inner layer to be fixed vertically. Vertical or Horizontal fixing permitted on outer layer only. Use full height or full length sheets where possible. All sheet joints must be fixed over solid timber framing. Vertical Joints of the outer layer should be offset 600mm from those of the inner layer. Sheet end butt joints must be formed over nogs. Offset the outer layer joints from the inner layer. Sheets shall be touch fitted.

Fixing of EPB Plasterboard Internal Linings

Fasteners

Inner layer: 41mm x 6g High Thread Drywall Screws

Outerlayer: 51mm x 7g High Thread Drywall Screws

Fastener Centres

Inner Layer: Fix at 600mm centres at sheet perimeter and all studs.

Outer Layer: Fix at 300mm centres at sheet perimeter and all studs.

Place fasteners 50mm from sheet corners along the top and bottom plates. On end studs place additional fasteners 50-60mm vertically and no close than 10mm from plate to stud connections.

Place fasteners no closer than 12mm from the sheet edges and 18mm from sheet ends. Avoid outer layer screws from hitting inner layer screws.

Jointing and Finishing of EPB Plasterboard

Inner Layer: Unstopped.

Outer Layer: All fastener heads stopped and all sheet joints reinforced with paper jointing tape and stopped. All in accordance with Elephant Plasterboard Installation Guide.

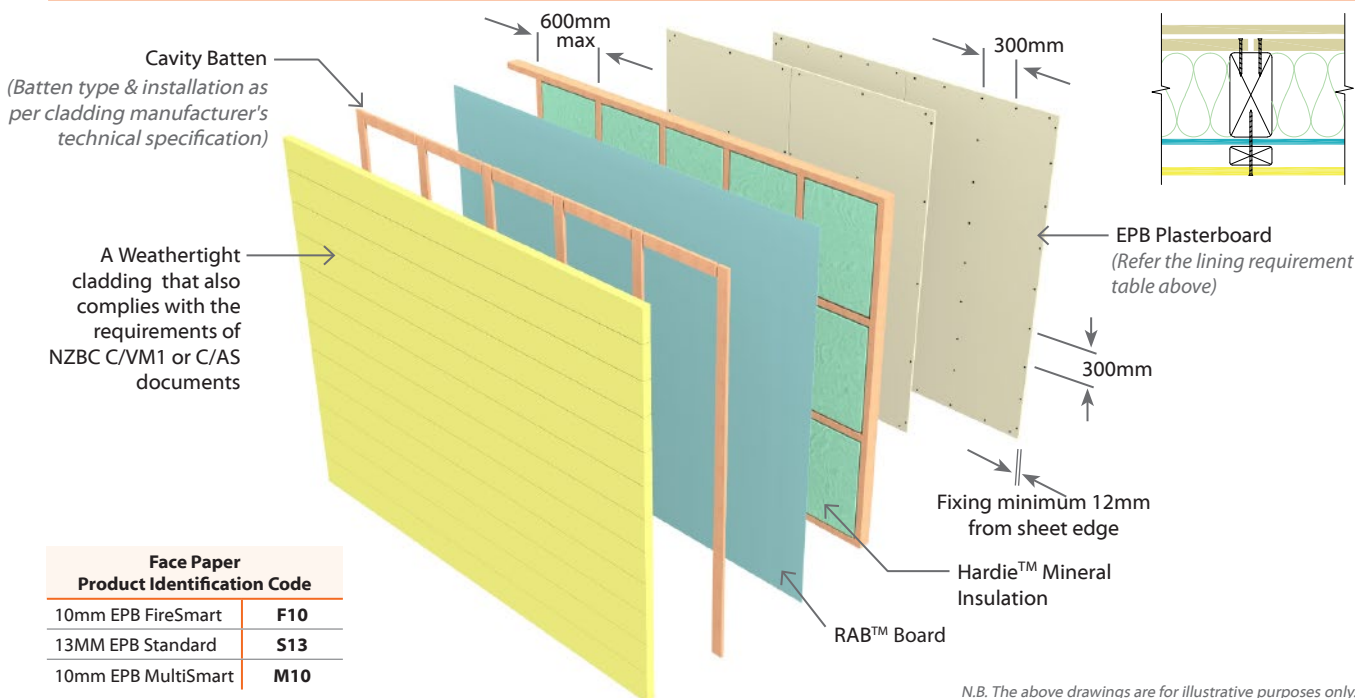

N.B. The above drawings are for illustrative purposes only.





External Steel Frame Walls

EJRH1SL30

EPB & RAB™ Board with selected James Hardie Fibre Cement Cladding

Two Way FRR

External Wall - Steel Frame

Load Bearing

System Number	Lining Suffix	FRR	Insulation	Noise Control STC	Lining Requirement
EJRH1SL30	-M13	30/30/30	Hardie™ Mineral	42 - 47	1 x 13mm EPB MultiSmart on Internal side James Hardie RAB™ Board with selected James Hardie cladding to External side
	-F16	30/30/30	Hardie™ Mineral	42 - 47	1 x 16mm EPB FireSmart on Internal side James Hardie RAB™ Board with selected James Hardie Fibre Cement cladding with to External side

Framing, Wall Height, Load and Framing Dimension

Steel framing for fire rated walls must be in accordance with NASH standard for residential and low rise buildings and AS/NZ 1170 standards. The framing shall also meet the following;

- Steel sections shall be galvanized/zinc coated and have a base metal thickness (BMT) 0.55mm minimum for non-load bearing walls and 0.75mm minimum for load bearing walls and 1.6mm maximum
- The minimum size for steel stud framing to be used in external walls shall be minimum 89mm deep x 36mm wide
- Maximum stud spacing 400mm c/c
- Maximum nogs / dwangs spacing 800mm c/c
- Steel frame must comply with the durability requirements of NZBC
- The fire rated walls built close to boundary are also required to achieve post fire stability in either direction as per SED in accordance with the NZBC verification method B1/VM1, paragraph 2.2.4

Thermal Fire Batten

Fire battens are used on all FRR steel stud systems and must be used between James Hardie Cladding and steel framing face.

Refer to section 4.6 of James Hardie Fire & Acoustic Design Manual for installation detail.

Pre-Cladding / Underlay

RAB™ Board

One layer of James Hardie RAB™ Board fixed to entire framing.

RAB™ Board must be used to achieve fire ratings

6mm RAB™ Board : Use 40 x 2.8mm fibre cement nail at 150mm centres

9mm RAB™ Board : Use 50 x 2.8mm fibre cement nail at 150mm centres

Fixing to be 12mm from sheet edges

Reference to be made to the James Hardie Home RAB™ Pre-Cladding & RAB™ Board Installation Manual.

Cavity Batten

Refer to the table below for the type of cavity batten required for the selected James Hardie system.

James Hardie Cladding System	Cavity Batten type
ExoTec™	Top Hat System
EasyLap™	CLD Structural Cavity Batten
Stria™ (Horizontally fixed)	
Axon™	

CLD™ Structural Cavity Batten:

Use 70 x 19mm CLD™ Structural Cavity Batten.

CLD™ Structural Cavity battens to be installed according to the selected type of James Hardie cladding and as per the relevant technical specification, refer page 29 of this manual.

ExoTec™ Top Hat System:

For ExoTec™ Top hat system installation instructions, refer to ExoTec™ Facade Panel Top Hat Rainscreen Technical Specification

James Hardie Fibre Cement Cladding

One layer of selected James Hardie Fibre Cement cladding to one side of the framing. See list below for allowable James Hardie claddings.

Selected Cladding System
ExoTec™
EasyLap™
Stria™ (Horizontally fixed)
Axon™

Refer to page 29 of this manual for the above mentioned James Hardie cladding's relevant technical literature.

Also refer to James Hardie Fire & Acoustic Design Manual.

Wall Insulation

Insulation must be installed between studs and nogs. Use Hardie™ Mineral insulation.

EPB Plasterboard Lining

NB: The installer must look for the Product Identification Code on the face paper to ensure the correct board type is installed. Refer to the Face Paper Product Identification Code table on this page.

One layer of EPB Plasterboard lining as per specified system above to internal side of the steel framing. Vertical fixing only permitted. Use full height sheets where possible. All sheet joints must be fixed over steel framing. Where sheet end butt joints are unavoidable, they must be formed over nogs. The layer is fixed hard to the floor. Sheet shall be touch fitted.

Fixing of EPB Plasterboard Internal Linings

Fasteners (As per Specified System Above)

System Number	Single Layer
	Self-Tapping Drywall Screws
EJRH1SL30-M13	13mm
	32 x 6g
EJRH1SL30-F16	16mm
	32 x 6g

Fastener Centres

Fix at 300mm centres up each stud with no fixing to top and bottom channel sections.

Place fasteners no closer than 12mm from the sheet edge and 50mm from sheet ends.

Place fasteners at 200mm centres where sheet end butt joints occur.

Jointing and Finishing of EPB Plasterboard

All fastener heads stopped and all sheet joints reinforced with paper jointing tape and stopped. All in accordance with Elephant Plasterboard Installation Guide.



EJRH1SL30

EPB & RAB™ Board with selected James Hardie Fibre Cement Cladding

Two Way FRR

External Wall - Steel Frame

Load Bearing

System Number	Lining Suffix	FRR	Insulation	Noise Control STC	Lining Requirement
EJRH1SL30	-M13	30/30/30	Hardie™ Mineral	42 - 47	1 x 13mm EPB MultiSmart on Internal side James Hardie RAB™ Board with selected James Hardie cladding to External side
	-F16	30/30/30	Hardie™ Mineral	42 - 47	1 x 16mm EPB FireSmart on Internal side James Hardie RAB™ Board with selected James Hardie Fibre Cement cladding with to External side

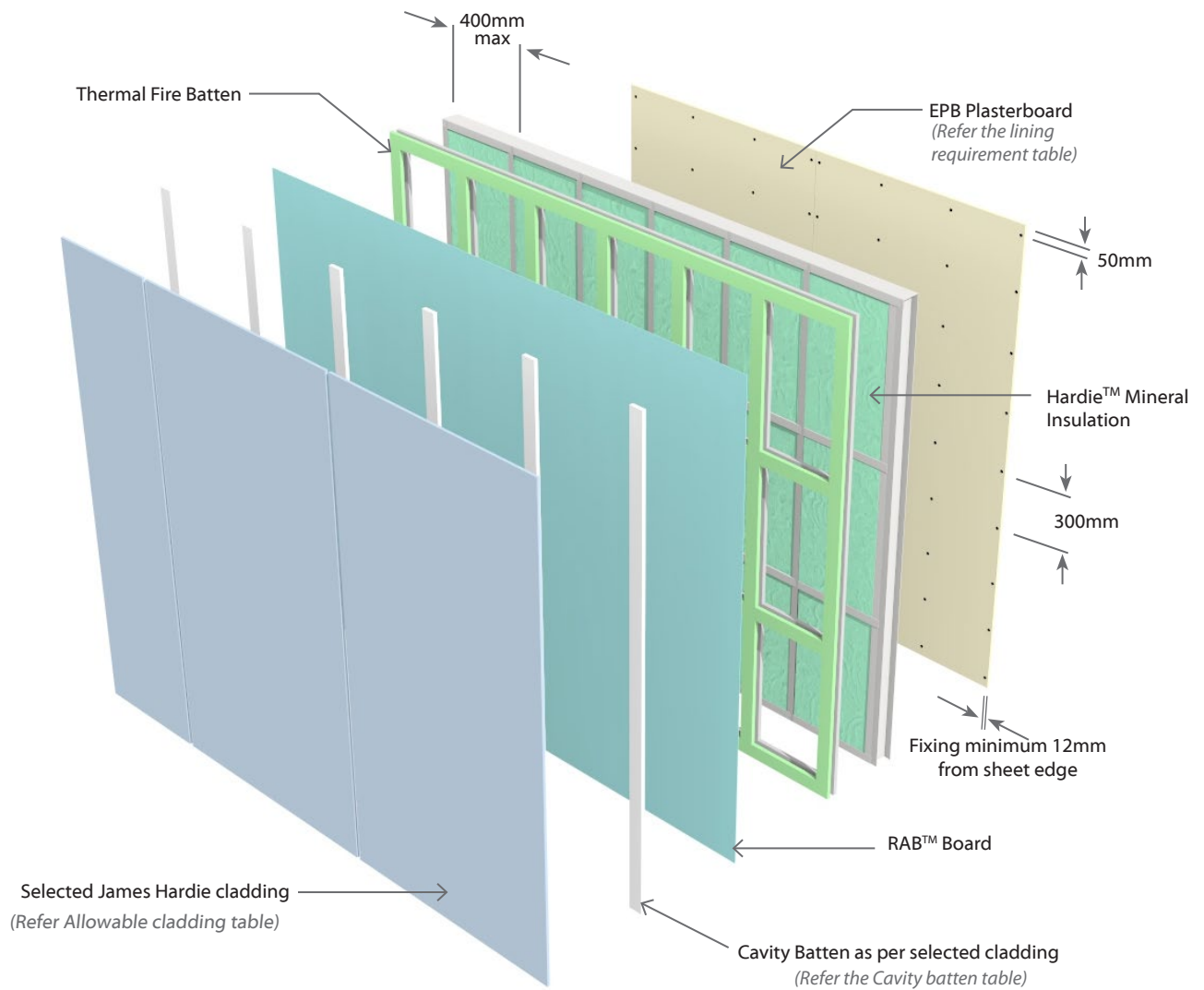
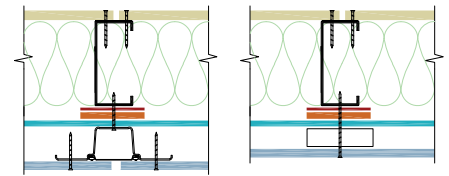

Face Paper Product Identification Code	
13mm EPB MultiSmart	M13
16mm EPB FireSmart	F16

N.B. The above drawings are for illustrative purposes only.



EJRH2SL30

EPB & RAB™ Board with selected James Hardie Fibre Cement Cladding

Two Way FRR

External Wall - Steel Frame

Load Bearing

System Number	Lining Suffix	FRR	Insulation	Noise Control STC	Lining Requirement
EJRH2SL30	-F20	30/30/30	Hardie™ Mineral	47 - 53	2 x 10mm EPB FireSmart on Internal side James Hardie RAB™ Board with selected James Hardie cladding to External side

Framing, Wall Height, Load and Framing Dimension

Steel framing for fire rated walls must be in accordance with NASH standard for residential and low rise buildings and AS/NZ 1170 standards. The framing shall also meet the following;

- Steel sections shall be galvanized/zinc coated and have a base metal thickness (BMT) 0.55mm minimum for non-load bearing walls and 0.75mm minimum for load bearing walls and 1.6mm maximum
- The minimum size for steel stud framing to be used in external walls shall be minimum 89mm deep x 36mm wide
- Maximum stud spacing 400mm c/c
- Maximum nogs / dwangs spacing 800mm c/c
- Steel frame must comply with the durability requirements of NZBC
- The fire rated walls built close to boundary are also required to achieve post fire stability in either direction as per SED in accordance with the NZBC verification method B1/VM1, paragraph 2.2.4

Thermal Fire Batten

Fire battens are used on all FRR steel stud systems and must be used between James Hardie Cladding and steel framing face.

Refer to section 4.6 of James Hardie Fire & Acoustic Design Manual for installation detail.

Pre-Cladding / Underlay

RAB™ Board

One layer of James Hardie RAB™ Board fixed to entire framing.

RAB™ Board must be used to achieve fire ratings

6mm RAB™ Board : Use 40 x 2.8mm fibre cement nail at 150mm centres

9mm RAB™ Board : Use 50 x 2.8mm fibre cement nail at 150mm centres

Fixing to be 12mm from sheet edges

Reference to be made to the James Hardie Home RAB™ Pre-Cladding & RAB™ Board Installation Manual.

Cavity Batten

Refer to the table below for the type of cavity batten required for the selected James Hardie system.

James Hardie Cladding System	Cavity Batten type
ExoTec™ EasyLap™ Stria™ (Horizontally fixed) Axon™	Top Hat System CLD Structural Cavity Batten

CLD™ Structural Cavity Batten:

Use 70 x 19mm CLD™ Structural Cavity Batten.

CLD™ Structural Cavity battens to be installed according to the selected type of James Hardie cladding and as per the relevant technical specification, refer page 29 of this manual.

ExoTec™ Top Hat System:

For ExoTec™ Top hat system installation instructions, refer to ExoTec™ Facade Panel Top Hat Rainscreen Technical Specification

James Hardie Fibre Cement Cladding

One layer of selected James Hardie Fibre Cement cladding to one side of the framing. See list below for allowable James Hardie claddings.

Selected Cladding Type
ExoTec™
EasyLap™
Stria™ (Horizontally fixed)
Axon™

Refer to page 29 of this manual for the above mentioned James Hardie cladding's relevant technical literature.

Also refer to James Hardie Fire & Acoustic Design Manual.

Wall Insulation

Insulation must be installed between studs and nogs. Use Hardie™ Mineral insulation.

EPB Plasterboard Lining

NB: The installer must look for the Product Identification Code on the face paper to ensure the correct board type is installed. Refer to the Face Paper Product Identification Code table on this page.

Two layers of 10mm EPB FireSmart lining to internal side of the steel framing.

Vertical fixing only permitted. Use full height sheets where possible. All vertical sheet joints must be fixed over framing. Vertical joints of the outer layer should be offset to those of the inner layer. Where sheet end butt joints are unavoidable, the inner layer joints must be formed over nogs. Stagger the outer layer butt joints from the inner layer by minimum 100mm. The layers are fixed hard to the floor. Sheets shall be touch fitted.

Fixing of EPB Plasterboard Internal Linings

Fasteners

System Number	1 st Layer	2 nd Layer
	Self-Tapping Drywall Screws	
EJRH2SL30-F20	10mm	10mm
	25 x 6g	32 x 6g

Fastener Centres

Inner Layer: Fix at 600mm centres up each stud with no fixing to top and bottom track sections.

Outer Layer: Fix at 300mm centres up each stud with no fixing to top and bottom track sections.

Place fasteners no closer than 12mm to the sheet edge and 50mm from sheet ends.

Place fasteners at 200mm centres where sheet end butt joints occur.

Avoid outer layer screws from hitting inner layer screws.

Jointing and Finishing of EPB Plasterboard

Inner Layer: Unstopped

Outer Layer: All fastener heads stopped and all sheet joints reinforced with paper jointing tape and stopped. All in accordance with Elephant Plasterboard Installation Guide.



EJRH2SL30

EPB & RAB™ Board with selected James Hardie Fibre Cement Cladding

Two Way FRR

External Wall - Steel Frame

Load Bearing

System Number	Lining Suffix	FRR	Insulation	Noise Control STC	Lining Requirement
EJRH2SL30	-F20	30/30/30	Hardie™ Mineral	47 - 53	2 x 10mm EPB FireSmart on Internal side James Hardie RAB™ Board with selected James Hardie cladding to External side

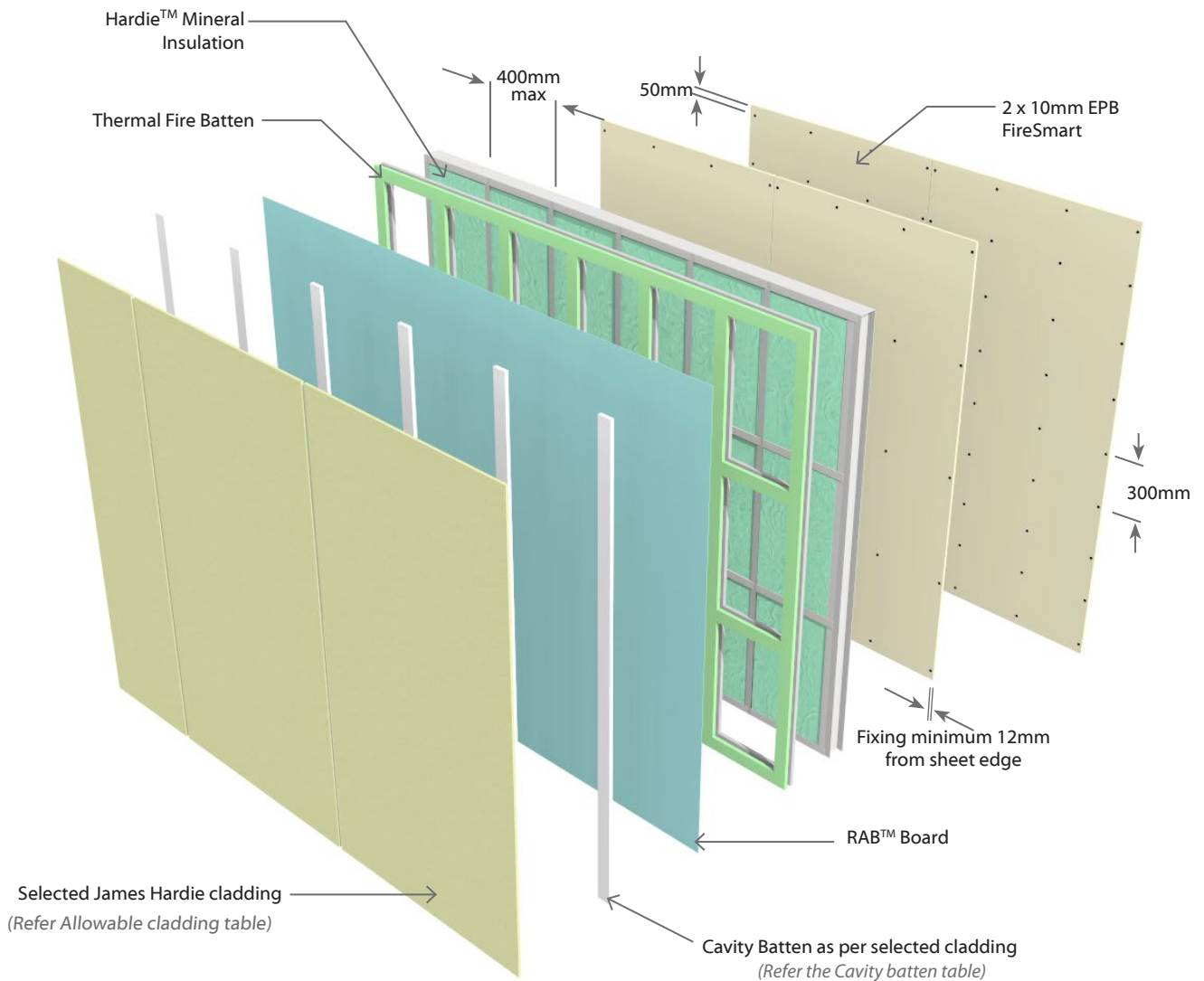
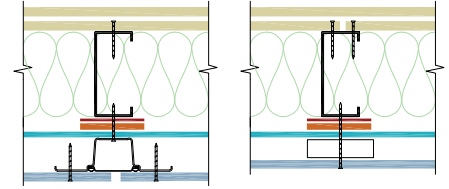

Face Paper Product Identification Code	
10mm EPB FireSmart	F10

N.B. The above drawings are for illustrative purposes only.



EJRH2SL60

EPB & RAB™ Board with selected James Hardie Fibre Cement Cladding

Two Way FRR

External Wall - Steel Frame

Load Bearing

System Number	Lining Suffix	FRR	Insulation	Noise Control STC	Lining Requirement
EJRH2SL60	-M26	60/60/60	Hardie™ Mineral	51- 54	2 x 13mm EPB MultiSmart on Internal side James Hardie RAB™ Board with selected James Hardie cladding to External side

Framing, Wall Height, Load and Framing Dimension

Steel framing for fire rated walls must be in accordance with NASH standard for residential and low rise buildings and AS/NZ 1170 standards. The framing shall also meet the following;

- Steel sections shall be galvanized/zinc coated and have a base metal thickness (BMT) 0.55mm minimum for non-load bearing walls and 0.75mm minimum for load bearing walls and 1.6mm maximum
- The minimum size for steel stud framing to be used in external walls shall be minimum 89mm deep x 36mm wide
- Maximum stud spacing 400mm c/c
- Maximum nogs / dwangs spacing 800mm c/c
- Steel frame must comply with the durability requirements of NZBC
- The fire rated walls built close to boundary are also required to achieve post fire stability in either direction as per SED in accordance with the NZBC verification method B1/VM1, paragraph 2.2.4

Thermal Fire Batten

Fire battens are used on all FRR steel stud systems and must be used between James Hardie Cladding and steel framing face.

Refer to section 4.6 of James Hardie Fire & Acoustic Design Manual for installation detail.

Pre-Cladding / Underlay

RAB™ Board

One layer of James Hardie RAB™ Board fixed to entire framing.

RAB™ Board must be used to achieve fire ratings

6mm RAB™ Board : Use 40 x 2.8mm fibre cement nail at 150mm centres

9mm RAB™ Board : Use 50 x 2.8mm fibre cement nail at 150mm centres

Fixing to be 12mm from sheet edges

Reference to be made to the James Hardie Home RAB™ Pre-Cladding & RAB™ Board Installation Manual.

Cavity Batten

Refer to the table below for the type of cavity batten required for the selected James Hardie system.

James Hardie Cladding System	Cavity Batten type
ExoTec™ EasyLap™ Stria™ (Horizontally fixed) Axon™	Top Hat System CLD Structural Cavity Batten

CLD™ Structural Cavity Batten:

Use 70 x 19mm CLD™ Structural Cavity Batten.

CLD™ Structural Cavity battens to be installed according to the selected type of James Hardie cladding and as per the relevant technical specification, refer page 29 of this manual.

ExoTec™ Top Hat System:

For ExoTec™ Top hat system installation instructions, refer to ExoTec™ Facade Panel Top Hat Rainscreen Technical Specification

James Hardie Fibre Cement Cladding

One layer of selected James Hardie Fibre Cement cladding to one side of the framing. See list below for allowable James Hardie claddings.

Selected Cladding Type
ExoTec™
EasyLap™
Stria™ (Horizontally fixed)
Axon™

Refer to page 29 of this manual for the above mentioned James Hardie cladding's relevant technical literature.

Also refer to James Hardie Fire & Acoustic Design Manual.

Wall Insulation

Insulation must be installed between studs and nogs. Use Hardie™ Mineral insulation.

EPB Plasterboard Lining

NB: The installer must look for the Product Identification Code on the face paper to ensure the correct board type is installed. Refer to the Face Paper Product Identification Code table on this page.

Two layers of 13mm EPB MultiSmart lining to internal side of the steel framing.

Vertical fixing only permitted. Use full height sheets where possible. All vertical sheet joints must be fixed over framing. Vertical joints of the outer layer should be offset to those of the inner layer. Where sheet end butt joints are unavoidable, the inner layer joints must be formed over nogs. Stagger the outer layer butt joints from the inner layer by minimum 100mm. The layers are fixed hard to the floor. Sheet shall be touch fitted.

Fixing of EPB Plasterboard Internal Linings

Fasteners

System Number	1 st Layer	2 nd Layer
	Self-Tapping Drywall Screws	
EJRH2SL60-M26	13mm	13mm
	25 x 6g	41 x 6g

Fastener Centres

Inner Layer: Fix at 600mm centres up each stud with no fixing to top and bottom track sections.

Outer Layer: Fix at 300mm centres up each stud with no fixing to top and bottom track sections.

Place fasteners no closer than 12mm to the sheet edge and 50mm from sheet ends.

Place fasteners at 200mm centres where sheet end butt joints occur.

Avoid outer layer screws from hitting inner layer screws.

Jointing and Finishing of EPB Plasterboard

Inner Layer: Unstopped

Outer Layer: All fastener heads stopped and all sheet joints reinforced with paper jointing tape and stopped. All in accordance with Elephant Plasterboard Installation Guide.



EJRH2SL60 EPB & RAB™ Board with selected James Hardie Fibre Cement Cladding | Two Way FRR

External Wall - Steel Frame					Load Bearing
System Number	Lining Suffix	FRR	Insulation	Noise Control STC	Lining Requirement
EJRH2SL60	-M26	60/60/60	Hardie™ Mineral	51- 54	2 x 13mm EPB MultiSmart on Internal side James Hardie RAB™ Board with selected James Hardie cladding to External side

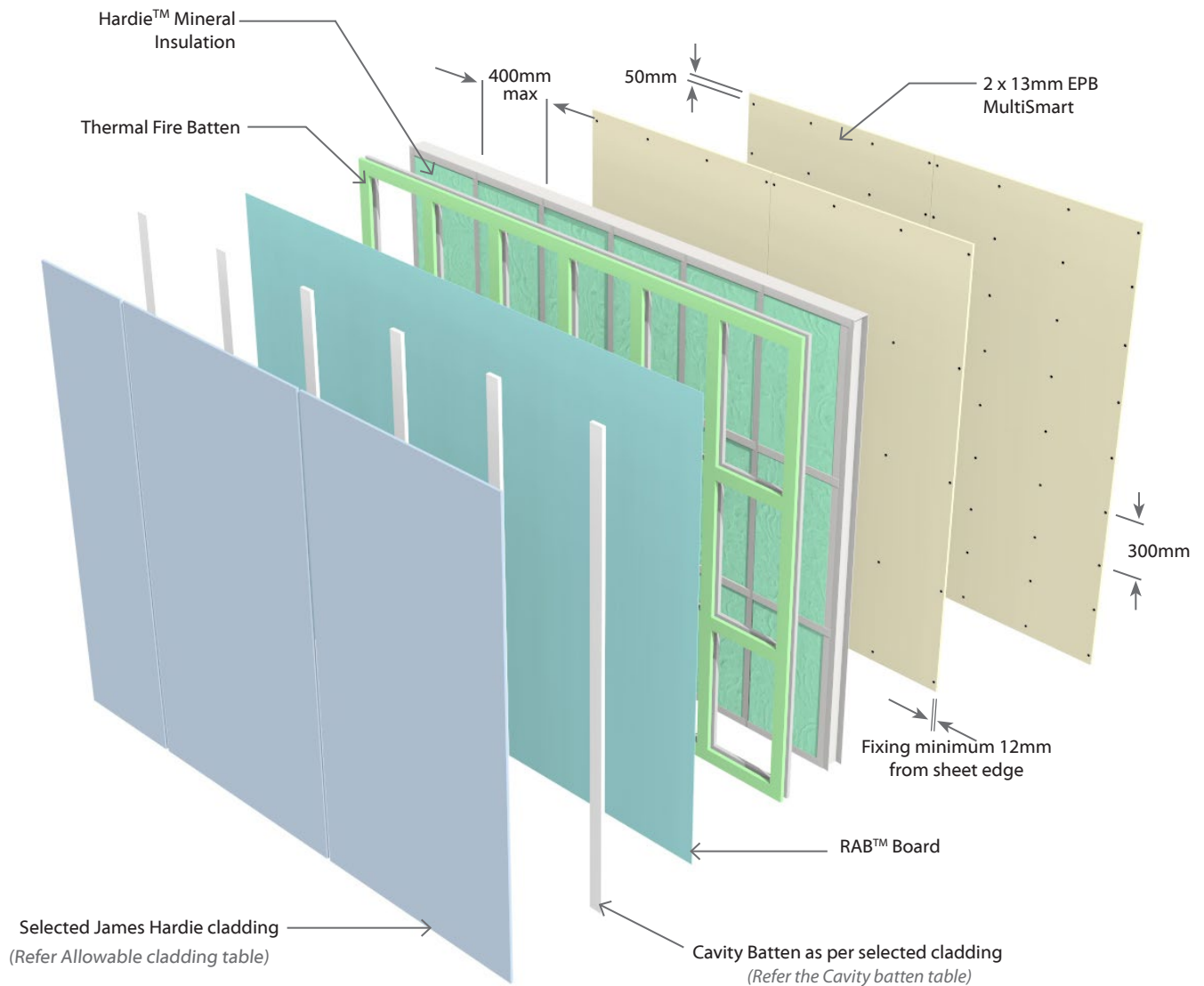
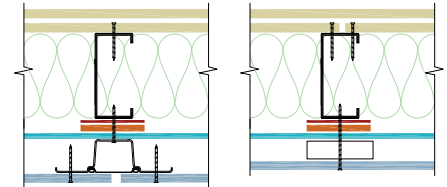

Face Paper Product Identification Code	
13mm EPB MultiSmart	M13

N.B. The above drawings are for illustrative purposes only.



EJRN1SL30

EPB & James Hardie RAB™ Board & a Weathertight Cladding

Two Way FRR

External Wall - Steel Frame

Load Bearing

System Number	Lining Suffix	FRR	Insulation	Noise Control STC	Lining Requirement
EJRN1SL30	-M13	30/30/30	Hardie™ Mineral	42	1 x 13mm EPB MultiSmart on Internal side James Hardie RAB™ Board with a Weathertight Cladding to External side
	-F16	30/30/30	Hardie™ Mineral	43	1 x 16mm EPB FireSmart on Internal side James Hardie RAB™ Board with a Weathertight Cladding to External side

Framing, Wall Height, Load and Framing Dimension

Steel framing for fire rated walls must be in accordance with NASH standard for residential and low rise buildings and AS/NZ 1170 standards. The framing shall also meet the following;

- Steel sections shall be galvanized/zinc coated and have a base metal thickness (BMT) 0.55mm minimum for non-load bearing walls and 0.75mm minimum for load bearing walls and 1.6mm maximum
- The minimum size for steel stud framing to be used in external walls shall be minimum 89mm deep x 36mm wide
- Maximum stud spacing 400mm centres
- Maximum nogs / dwangs spacing 800mm centres
- Steel frame must comply with the durability requirements of NZBC
- The fire rated walls built close to boundary are also required to achieve post fire stability in either direction as per SED in accordance with the NZBC verification method B1/VM1, paragraph 2.2.4

Thermal Fire Batten

Fire battens are used on all FRR steel stud systems and must be used between James Hardie Cladding and steel framing face.

Refer to section 4.6 of James Hardie Fire & Acoustic Design Manual for installation detail.

Pre-Cladding

RAB™ Board

One layer of James Hardie RAB™ Board fixed to entire framing.

6mm RAB™ Board : Use 40 x 2.8mm fibre cement nail at 150mm centres

9mm RAB™ Board : Use 50 x 2.8mm fibre cement nail at 150mm centres

Fixing to be 12mm from sheet edges

Reference to be made to the James Hardie Home RAB™ Pre-Cladding & RAB™ Board Installation Manual.

Cavity Batten

Cavity battens to be installed according to the selected type of Cladding and its manufacturer's relevant technical specification.

Weathertight Cladding

The exterior wall must be clad with a suitable weathertight material. Cladding fixed as per manufacturer's technical specification.

N.B: It is important to consider the fire properties of the external cladding is in accordance with NZBC C/VM1 or C/AS documents.

Refer to Table 5.1 of Section 5.4 of C/AS1 and Table 5.5 of Section 5.8.1 of C/AS2 for the information about various risk groups to identify the external fire spread safety requirement applicable to the exterior surface finishes.

Wall Insulation

Insulation must be installed between studs and nogs. Use Hardie™ Mineral insulation.

EPB Plasterboard Lining

NB: The installer must look for the Product Identification Code on the face paper to ensure the correct board type is installed. Refer to the Face Paper Product Identification Code table on this page.

One layer of EPB Plasterboard lining as per specified system above to internal side of the steel framing. Vertical fixing only permitted. Use full height sheets where possible. All sheet joints must be fixed over steel framing. Where sheet end butt joints are unavoidable, they must be formed over nogs. The layer is fixed hard to the floor. Sheet shall be touch fitted.

Fixing of EPB Plasterboard Internal Linings

Fasteners (As per Specified System Above)

System Number	Single Layer
	Self-Tapping Drywall Screws
EJRN1SL30-M13	13mm
	32 x 6g
EJRN1SL30-F16	16mm
	32 x 6g

Fastener Centres

Fix at 300mm centres up each stud with no fixing to top and bottom channel sections.

Place fasteners no closer than 12mm from the sheet edge and 50mm from sheet ends.

Place fasteners at 200mm centres where sheet end butt joints occur.

Jointing and Finishing of EPB Plasterboard

All fastener heads stopped and all sheet joints reinforced with paper jointing tape and stopped. All in accordance with Elephant Plasterboard Installation Guide.



EJRN1SL30 EPB & James Hardie RAB™ Board & a Weathertight Cladding | Two Way FRR

External Wall - Steel Frame					Load Bearing
System Number	Lining Suffix	FRR	Insulation	Noise Control STC	Lining Requirement
EJRN1SL30	-M13	30/30/30	Hardie™ Mineral	42	1 x 13mm EPB MultiSmart on Internal side James Hardie RAB™ Board with a Weathertight Cladding to External side
	-F16	30/30/30	Hardie™ Mineral	43	1 x 16mm EPB FireSmart on Internal side James Hardie RAB™ Board with a Weathertight Cladding to External side

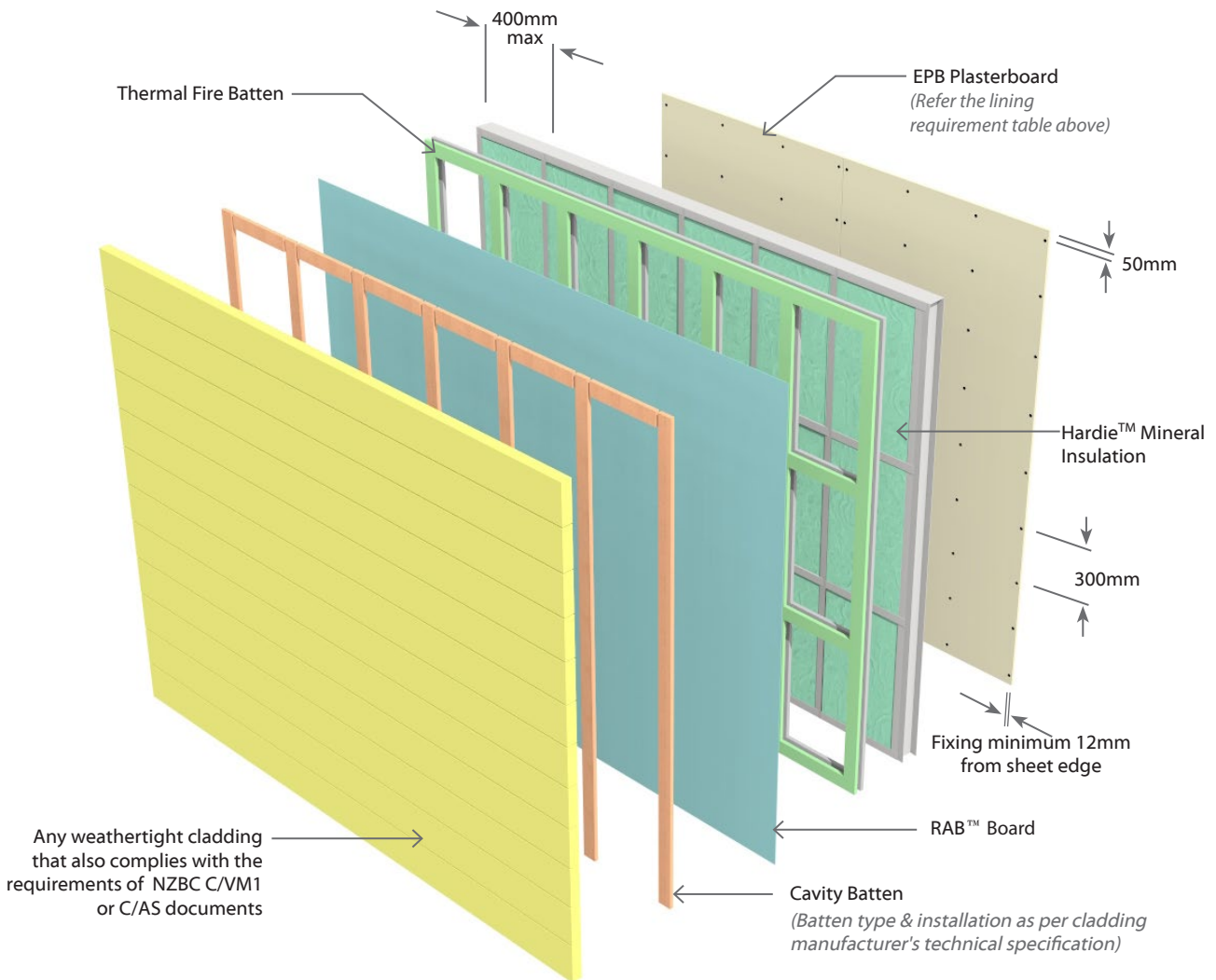
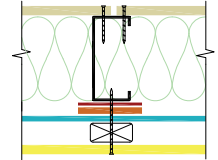

Face Paper Product Identification Code	
13mm EPB MultiSmart	M13
16mm EPB FireSmart	F16

N.B. The above drawings are for illustrative purposes only.



EJRN2SL30

EPB & James Hardie RAB™ Board & a Weathertight Cladding

Two Way FRR

External Wall - Steel Frame

Load Bearing

System Number	Lining Suffix	FRR	Insulation	Noise Control STC	Lining Requirement
EJRN2SL30	-F20	30/30/30	Hardie™ Mineral	47	2 x 10mm EPB FireSmart on Internal side James Hardie RAB™ Board with a Weathertight Cladding to External side

Framing, Wall Height, Load and Framing Dimension

Steel framing for fire rated walls must be in accordance with NASH standard for residential and low rise buildings and AS/NZ 1170 standards. The framing shall also meet the following;

- Steel sections shall be galvanized/zinc coated and have a base metal thickness (BMT) 0.55mm minimum for non-load bearing walls and 0.75mm minimum for load bearing walls and 1.6mm maximum
- The minimum size for steel stud framing to be used in external walls shall be minimum 89mm deep x 36mm wide
- Maximum stud spacing 400mm centres
- Maximum nogs / dwangs spacing 800mm centres
- Steel frame must comply with the durability requirements of NZBC
- The fire rated walls built close to boundary are also required to achieve post fire stability in either direction as per SED in accordance with the NZBC verification method B1/VM1, paragraph 2.2.4

Thermal Fire Batten

Fire battens are used on all FRR steel stud systems and must be used between James Hardie Cladding and steel framing face.

Refer to section 4.6 of James Hardie Fire & Acoustic Design Manual for installation detail.

Pre-Cladding

RAB™ Board

One layer of James Hardie RAB™ Board fixed to entire framing.

6mm RAB™ Board : Use 40 x 2.8mm fibre cement nail at 150mm centres

9mm RAB™ Board : Use 50 x 2.8mm fibre cement nail at 150mm centres

Fixing to be 12mm from sheet edges

Reference to be made to the James Hardie Home RAB™ Pre-Cladding & RAB™ Board Installation Manual.

Cavity Batten

Cavity battens to be installed according to the selected type of Cladding and its manufacturer's relevant technical specification.

Weathertight Cladding

The Exterior wall must be clad with a suitable weathertight material. Cladding fixed as per manufacturer's technical specification.

N.B: It is important to consider the fire properties of the external cladding is in accordance with NZBC C/VM1 or C/AS documents.

Refer to Table 5.1 of Section 5.4 of C/AS1 and Table 5.5 of Section 5.8.1 of C/AS2 for the information about various risk groups to identify the external fire spread safety requirement applicable to the exterior surface finishes.

Wall Insulation

Insulation must be installed between studs and nogs. Use Hardie™ Mineral insulation.

EPB Plasterboard Lining

NB: The installer must look for the Product Identification Code on the face paper to ensure the correct board type is installed. Refer to the Face Paper Product Identification Code table on this page.

Two layers of 10mm EPB FireSmart lining as per specified system above to internal side of the steel framing.

Vertical fixing only permitted. Use full height sheets where possible. All vertical sheet joints must be fixed over framing. Vertical joints of the outer layer should be offset to those of the inner layer. Where sheet end butt joints are unavoidable, the inner layer joints must be formed over nogs. Stagger the outer layer butt joints from the inner layer by minimum 100mm. The layers are fixed hard to the floor. Sheets shall be touch fitted.

Fixing of EPB Plasterboard Internal Linings

Fasteners

System Number	1 st Layer	2 nd Layer
	Self-Tapping Drywall Screws	
EJRN2SL30-F20	10mm	10mm
	25 x 6g	32 x 6g

Fastener Centres

Inner Layer: Fix at 600mm centres up each stud with no fixing to top and bottom track sections.

Outer Layer: Fix at 300mm centres up each stud with no fixing to top and bottom track sections.

Place fasteners no closer than 12mm to the sheet edge and 50mm from sheet ends.

Place fasteners at 200mm centres where sheet end butt joints occur.

Avoid outer layer screws from hitting inner layer screws.

Jointing and Finishing of EPB Plasterboard

Inner Layer: Unstopped

Outer Layer: All fastener heads stopped and all sheet joints reinforced with paper jointing tape and stopped. All in accordance with Elephant Plasterboard Installation Guide.



EJRN2SL30 EPB & James Hardie RAB™ Board & a Weathertight Cladding

Two Way FRR

External Wall - Steel Frame

Load Bearing

System Number	Lining Suffix	FRR	Insulation	Noise Control STC	Lining Requirement
EJRN2SL30	-F20	30/30/30	Hardie™ Mineral	47	2 x 10mm EPB FireSmart on Internal side James Hardie RAB™ Board with a Weathertight Cladding to External side

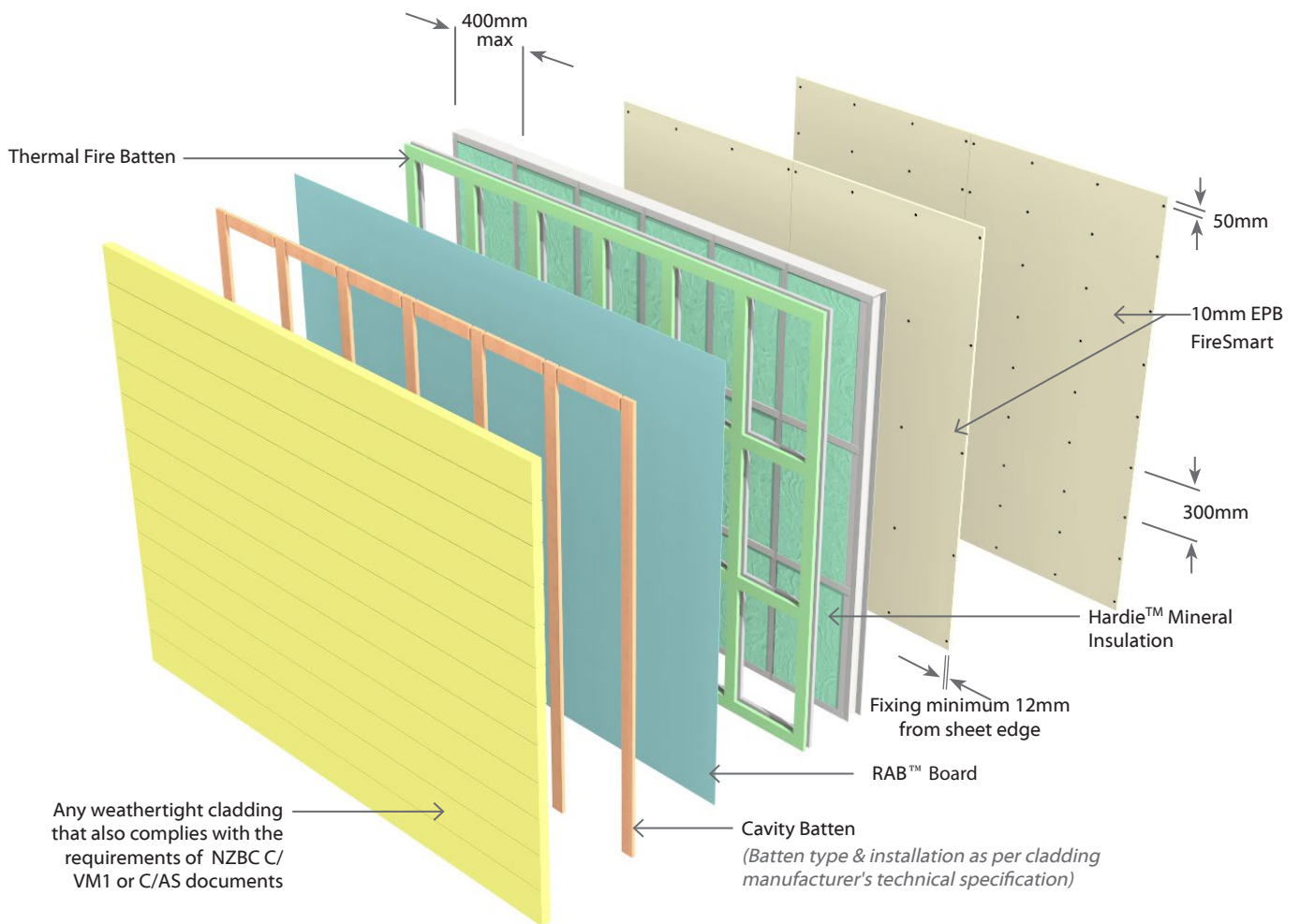
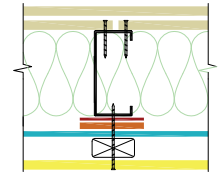

Face Paper Product Identification Code	
10mm EPB FireSmart	F10

N.B. The above drawings are for illustrative purposes only.



EJRN2SL60

EPB & James Hardie RAB™ Board & a Weathertight Cladding

Two Way FRR

External Wall - Steel Frame

Load Bearing

System Number	Lining Suffix	FRR	Insulation	Noise Control STC	Lining Requirement
EJRN2SL60	-M26	60/60/60	Hardie™ Mineral	49	2 x 13mm EPB MultiSmart on Internal side James Hardie RAB™ Board with a Weathertight Cladding to External side

Framing, Wall Height, Load and Framing Dimension

Steel framing for fire rated walls must be in accordance with NASH standard for residential and low rise buildings and AS/NZ 1170 standards. The framing shall also meet the following;

- Steel sections shall be galvanized/zinc coated and have a base metal thickness (BMT) 0.55mm minimum for non-load bearing walls and 0.75mm minimum for load bearing walls and 1.6mm maximum
- The minimum size for steel stud framing to be used in external walls shall be minimum 89mm deep x 36mm wide
- Maximum stud spacing 400mm centres
- Maximum nogs / dwangs spacing 800mm centres
- Steel frame must comply with the durability requirements of NZBC
- The fire rated walls built close to boundary are also required to achieve post fire stability in either direction as per SED in accordance with the NZBC verification method B1/VM1, paragraph 2.2.4

Thermal Fire Batten

Fire battens are used on all FRR steel stud systems and must be used between James Hardie Cladding and steel framing face.

Refer to section 4.6 of James Hardie Fire & Acoustic Design Manual for installation detail.

Pre-Cladding

RAB™ Board

One layer of James Hardie RAB™ Board fixed to entire framing.

6mm RAB™ Board : Use 40 x 2.8mm fibre cement nail at 150mm centres

9mm RAB™ Board : Use 50 x 2.8mm fibre cement nail at 150mm centres

Fixing to be 12mm from sheet edges

Reference to be made to the James Hardie Home RAB™ Pre-Cladding & RAB™ Board Installation Manual.

Cavity Batten

Cavity battens to be installed according to the selected type of Cladding and its manufacturer's relevant technical specification.

Weathertight Cladding

The Exterior wall must be clad with a suitable weathertight material. Cladding fixed as per manufacturer's technical specification.

N.B: It is important to consider the fire properties of the external cladding is in accordance with NZBC C/VM1 or C/AS documents.

Refer to Table 5.1 of Section 5.4 of C/AS1 and Table 5.5 of Section 5.8.1 of C/AS2 for the information about various risk groups to identify the external fire spread safety requirement applicable to the exterior surface finishes.

Wall Insulation

Insulation must be installed between studs and nogs. Use Hardie™ Mineral insulation.

EPB Plasterboard Lining

NB: The installer must look for the Product Identification Code on the face paper to ensure the correct board type is installed. Refer to the Face Paper Product Identification Code table on this page.

Two layers of 13mm EPB MultiSmart lining to internal side of the steel framing. Vertical fixing only permitted. Use full height sheets where possible. All vertical sheet joints must be fixed over framing. Vertical joints of the outer layer should be offset to those of the inner layer. Where sheet end butt joints are unavoidable, the inner layer joints must be formed over nogs. Stagger the outer layer butt joints from the inner layer by minimum 100mm. The layers are fixed hard to the floor. Sheet shall be touch fitted.

Fixing of EPB Plasterboard Internal Linings

Fasteners

System Number	1 st Layer	2 nd Layer
	Self-Tapping Drywall Screws	
EJRN2SL60-M26	13mm 25 x 6g	13mm 41 x 6g

Fastener Centres

Inner Layer: Fix at 600mm centres up each stud with no fixing to top and bottom track sections.

Outer Layer: Fix at 300mm centres up each stud with no fixing to top and bottom track sections.

Place fasteners no closer than 12mm to the sheet edge and 50mm from sheet ends.

Place fasteners at 200mm centres where sheet end butt joints occur.

Avoid outer layer screws from hitting inner layer screws.

Jointing and Finishing of EPB Plasterboard

Inner Layer: Unstopped

Outer Layer: All fastener heads stopped and all sheet joints reinforced with paper jointing tape and stopped. All in accordance with Elephant Plasterboard Installation Guide.



EJRN2SL60 EPB & James Hardie RAB™ Board & a Weathertight Cladding

Two Way FRR

External Wall - Steel Frame

Load Bearing

System Number	Lining Suffix	FRR	Insulation	Noise Control STC	Lining Requirement
EJRN2SL60	-M26	60/60/60	Hardie™ Mineral	49	2 x 13mm EPB MultiSmart on Internal side James Hardie RAB™ Board with a Weathertight Cladding to External side

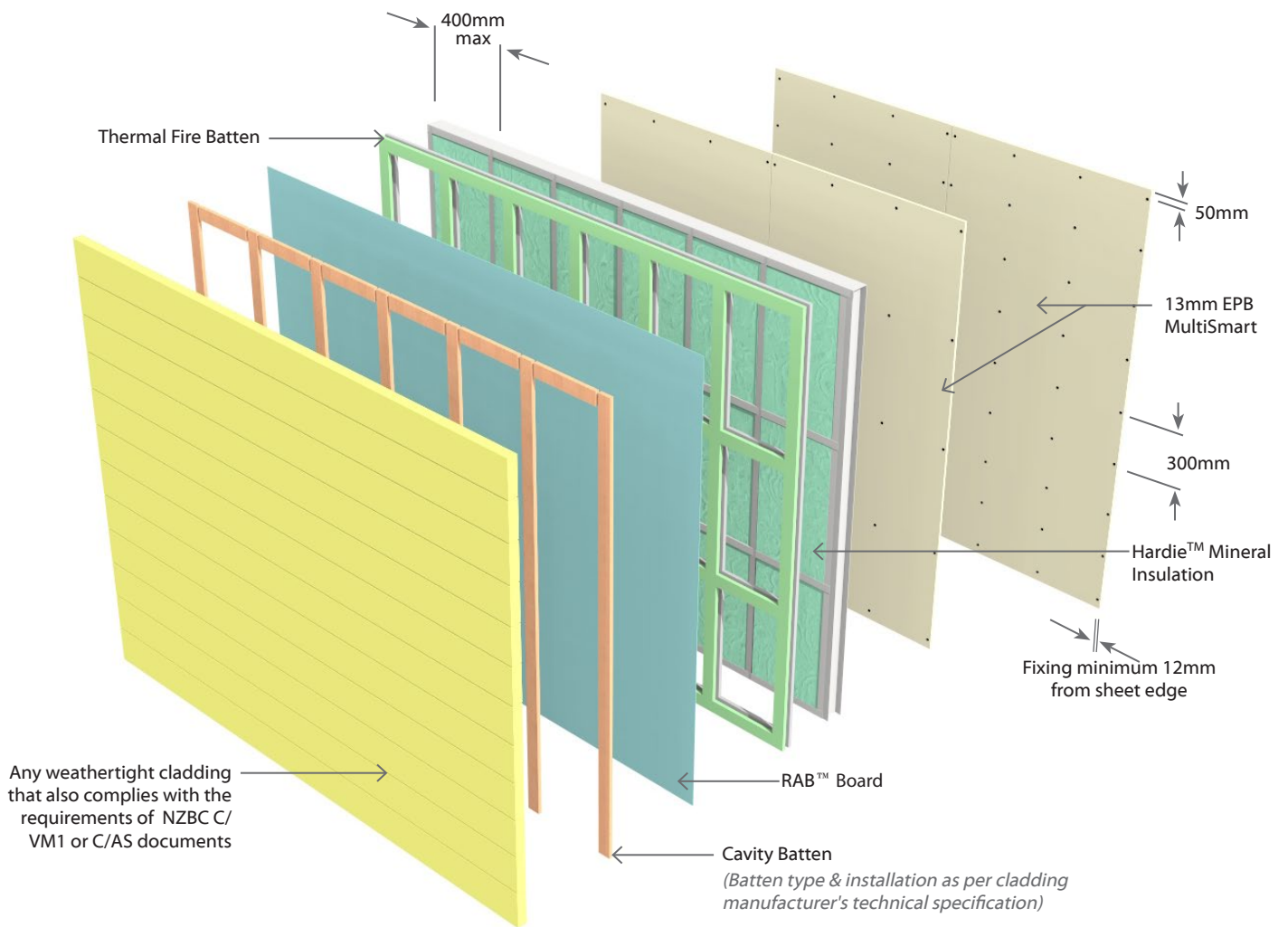
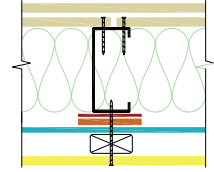

Face Paper Product Identification Code	
13mm EPB MultiSmart	M13

N.B. The above drawings are for illustrative purposes only.





Internal Timber Frame Walls

EJV1TL30 EPB Plasterboard & James Hardie Villaboard™ Lining Two Way FRR

Internal Wall - Timber Frame Load Bearing

System Number	Lining Suffix	FRR	Insulation	Noise Control STC	Lining Requirement
EJV1TL30	-F10	30/30/30	R2.2 glass wool	42	1 x 10mm EPB FireSmart one side James Hardie Villaboard™ Lining other side

Framing, Wall Height, Load and Framing Dimension

Timber framing to comply with relevant sections and clauses of NZBC B1: Structure and NZBC B2: Durability. Timber framing must be in accordance with NZS3604 stud tables for load bearing or non-load bearing partitions. Furthermore;

- Minimum framing dimension is 90 x 45mm.
- Nogs must be in place at a maximum of 800mm centres.
- Maximum stud spacing's are 600mm centres.
- The fire rated walls built close to boundary are also required to achieve post fire stability in either direction in accordance with the NZBC verification method B1/VM1, paragraph 2.2.4

Refer to latest James Hardie Fire & Acoustic Design Manual figures and tables for further detail.

James Hardie Villaboard™ Lining

Fix James Hardie Villaboard™ Lining to one side of framing. Refer to James Hardie Villaboard™ Lining Installation Manual for information regarding fixing and finishing.

Wall Insulation

Insulation must be installed between studs and nogs. Use 90mm thick R2.2 glass wool insulation.

EPB Plasterboard Lining

NB: The installer must look for the Product Identification Code on the face paper to ensure the correct board type is installed. Refer to the Face Paper Product Identification Code table on this page.

One layer of 10mm EPB FireSmart lining to framing. Vertical fixing only permitted. Use full height sheets where possible when fixing vertical. All sheet joints must be fixed over solid timber framing. Sheets shall be touch fitted.

Fixing of EPB Plasterboard Internal Linings

Fasteners

41mm x 6g High Thread Drywall screws

Fastener Centres

Fix at 300mm centres at sheet perimeter and up all other studs. Place fasteners 50mm from sheet corners along the top and bottom plates. On end studs place additional fasteners 50-60mm vertically and no closer than 10mm from plate to stud connections. Place fasteners no closer than 12mm from the sheet edges and 18mm from sheet ends. Place fasteners at 200mm centres where sheet end butt joints occur.

Jointing and Finishing of EPB Plasterboard

All fastener heads stopped and all sheet joints reinforced with paper jointing tape and stopped. All in accordance with Elephant Plasterboard Installation Guide.

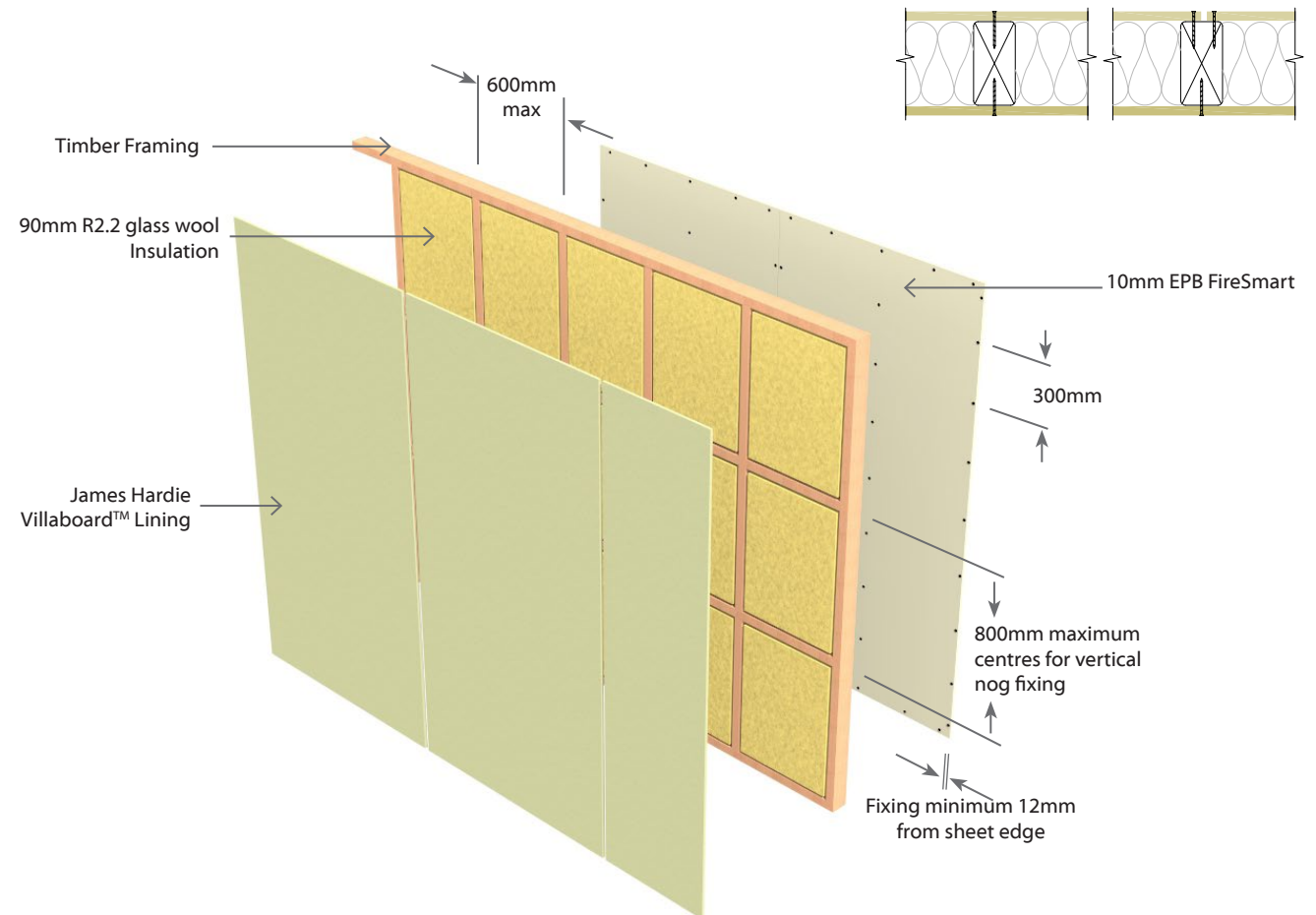

N.B. The above drawings are for illustrative purposes only.



EJV1TL60 EPB Plasterboard & James Hardie Villaboard™ Lining Two Way FRR

Internal Wall - Timber Frame Load Bearing

System Number	Lining Suffix	FRR	Insulation	Noise Control STC	Lining Requirement
EJV1TL60	-M13	60/60/60	Hardie™ Mineral	43	1 x 13mm EPB MultiSmart one side James Hardie Villaboard™ Lining other side

Framing, Wall Height, Load and Framing Dimension

Timber framing to comply with relevant sections and clauses of NZBC B1: Structure and NZBC B2: Durability. Timber framing must be in accordance with NZS3604 stud tables for load bearing or non-load bearing partitions. Furthermore;

- Minimum framing dimension is 90 x 45mm.
- Nogs must be in place at a maximum of 800mm centres.
- Maximum stud spacing's are 600mm centres.
- The fire rated walls built close to boundary are also required to achieve post fire stability in either direction in accordance with the NZBC verification method B1/VM1, paragraph 2.2.4

Refer to latest James Hardie Fire & Acoustic Design Manual figures and tables for further detail.

James Hardie Villaboard™ Lining

Fix James Hardie Villaboard™ Lining to one side of framing. Refer to James Hardie Villaboard™ Lining Installation Manual for information regarding fixing and finishing.

Wall Insulation

Insulation must be installed between studs and nogs. Use 90mm thick James Hardie Mineral Insulation.

EPB Plasterboard Lining

NB: The installer must look for the Product Identification Code on the face paper to ensure the correct board type is installed. Refer to the Face Paper Product Identification Code table on this page.

One layer of 13mm EPB MultiSmart lining to framing. Vertical fixing only permitted. Use full height sheets where possible when fixing vertical. All sheet joints must be fixed over solid timber framing. Sheets shall be touch fitted.

Fixing of EPB Plasterboard Internal Linings

Fasteners

41mm x 6g High Thread Drywall screws

Fastener Centres

Fix at 300mm centres at sheet perimeter and up all other studs. Place fasteners 50mm from sheet corners along the top and bottom plates. On end studs place additional fasteners 50-60mm vertically and no close than 10mm from plate to stud connections.

Place fasteners no closer than 12mm from the sheet edges and 18mm from sheet ends. Place fasteners at 200mm centres where sheet end butt joints occur.

Jointing and Finishing of EPB Plasterboard

All fastener heads stopped and all sheet joints reinforced with paper jointing tape and stopped. All in accordance with Elephant Plasterboard Installation Guide.

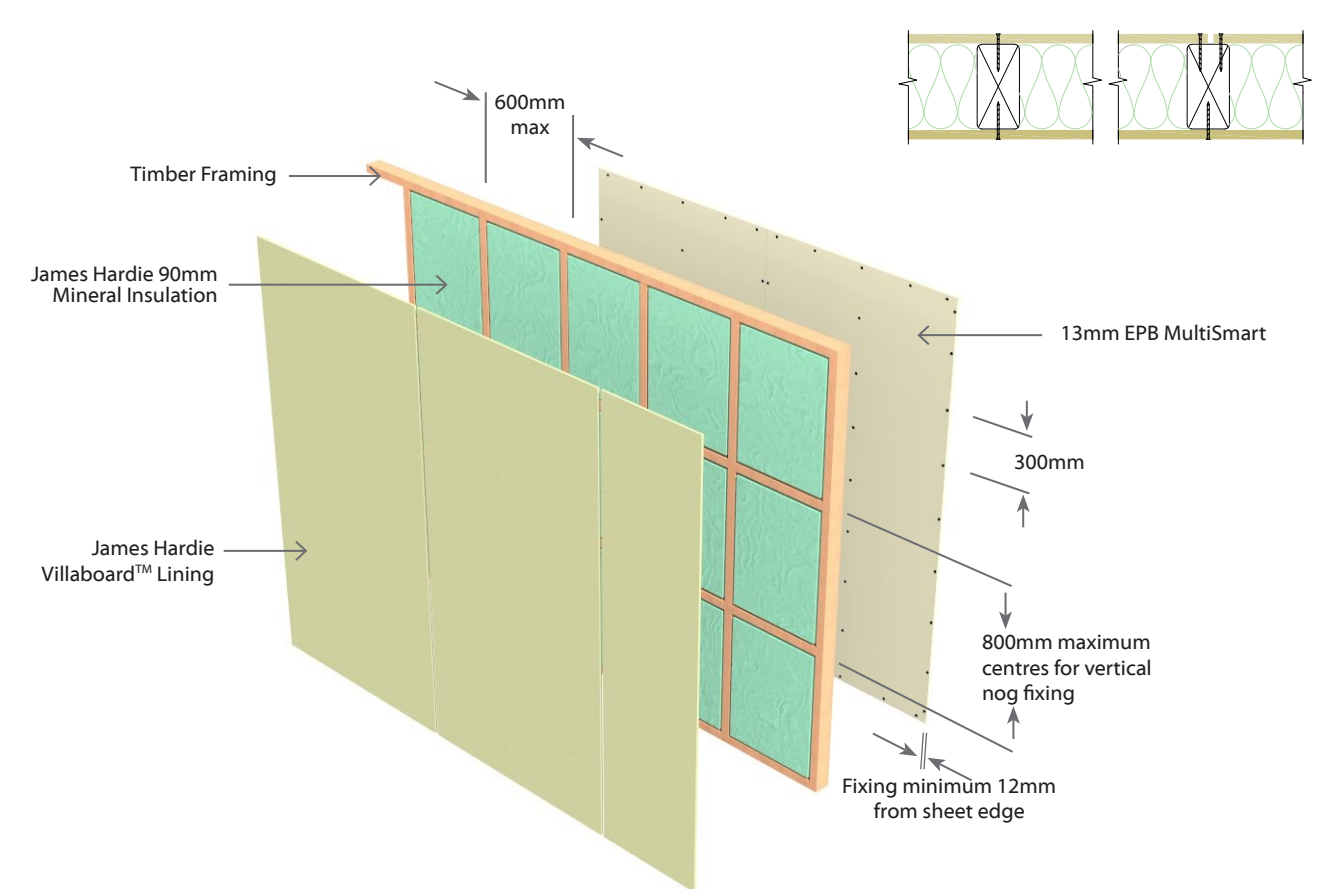

N.B. The above drawings are for illustrative purposes only.





Floor/Ceiling Systems

EJS1FC30

EPB Plasterboard & James Hardie Secura™ Interior Flooring

Floor/Ceiling - Timber Joist					Load Bearing
System Number	Lining Suffix	FRR	Noise Control		Lining Requirement
			STC	IIC	
EJS1FC30	-M13	30/30/30	45	33	1 x 13mm EPB MultiSmart under the frame 19mm James Hardie Secura™ Interior Flooring above the frame

Floor Framing

Timber floor joists shall comply with NZS3604 with a minimum depth of 190mm x 45mm and spaced at no more than 450mm centres.

Solid strutting at 1800mm maximum centres required.

Nogs fixed on the flat to receive the ends of flooring material shall be 100 x 50mm minimum.

Nogs fixed on the flat to receive the EPB Plasterboard lining shall be 75mm x 50mm minimum.

Nogs or framing is required at the perimeter of the fire rated ceiling. Refer to James Hardie Fire & Acoustic Design Manual.

Secura™ Interior Flooring

19mm Secura™ Interior Flooring, fixed to the joists at 200mm centres using 50 x 2.8mm round head nails.

25mm minimum distance from tongue and groove

12mm minimum edge distance

Also refer to James Hardie Secura Interior Flooring Installation Manual.

EPB Plasterboard Lining

NB: The installer must look for the Product Identification Code on the face paper to ensure the correct board type is installed. Refer to the Face Paper Product Identification Code table on this page.

One layer of 13mm EPB MultiSmart fixed at right angles directly to the underside of floor joists.

All joints must occur on joists and solid blocking. Sheets to be touched fitted.

Fixing of EPB Plasterboard Internal Linings

Fasteners

41mm x 6g High Thread Drywall screws

Fastener Centres

Fix at 200mm centres around the sheet perimeter and intermediate joists.

Place fasteners no closer than 12mm from the sheet edge and 18mm from sheet ends.

Jointing and Finishing of EPB Plasterboard

All fastener heads stopped and all sheet joints reinforced with paper jointing tape and stopped. All in accordance with Elephant Plasterboard Installation Guide.

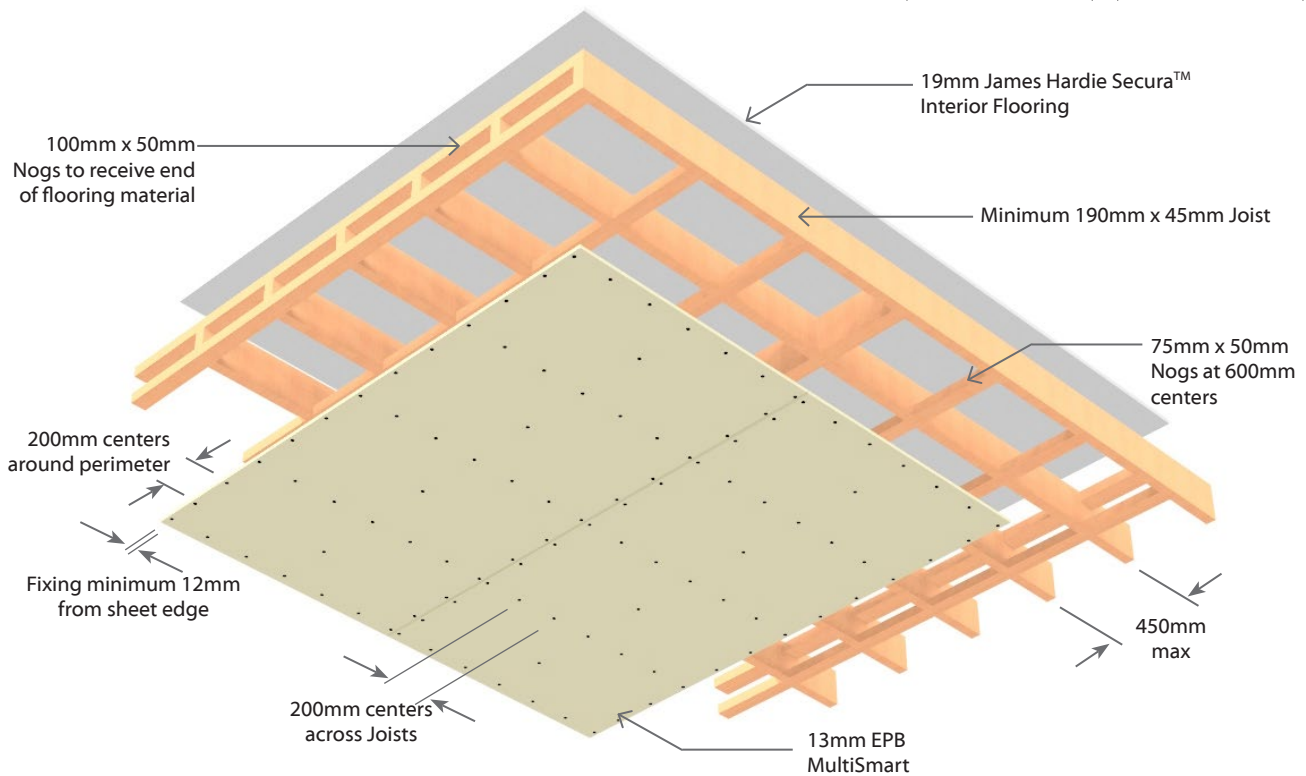
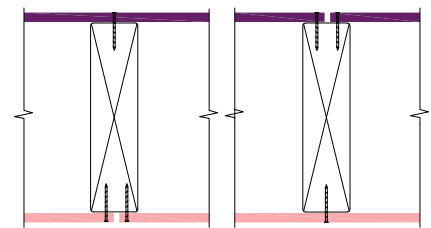

N.B. The above drawings are for illustrative purposes only.



EJS1FC60

EPB Plasterboard & James Hardie Secura™ Interior Flooring

Floor/Ceiling - Timber Joist

Load Bearing

System Number	Lining Suffix	FRR	Noise Control		Lining Requirement
			STC	IIC	
EJS1FC60	-F16	60/60/60	46	33	1 x 16mm EPB FireSmart under the frame 19mm James Hardie Secura™ Interior Flooring above the frame

Floor Framing

Timber floor joists shall comply with NZS3604 with a minimum depth of 190mm x 45mm and spaced at no more than 450mm centres.

Solid strutting at 1800mm maximum centres required.

Nogs fixed on the flat to receive the ends of flooring material shall be 100 x 50mm minimum.

Nogs fixed on the flat to receive the EPB Plasterboard lining shall be 75mm x 50mm minimum.

Nogs or framing is required at the perimeter of the fire rated ceiling. Refer to James Hardie Fire & Acoustic Design Manual.

Secura™ Interior Flooring

19mm Secura™ Interior Flooring, fixed to the joists at 200mm centres using 50 x 2.8mm round head nails.

25mm minimum distance from tongue and groove

12mm minimum edge distance

Also refer to James Hardie Secura Interior Flooring Installation Manual.

EPB Plasterboard Lining

NB: The installer must look for the Product Identification Code on the face paper to ensure the correct board type is installed. Refer to the Face Paper Product Identification Code table on this page.

One layer of 16mm EPB FireSmart fixed at right angles directly to the underside of floor joists.

All joints must occur on joists and solid blocking. Sheets to be touched fitted.

Fixing of EPB Plasterboard Internal Linings

Fasteners

51mm x 7g High Thread Drywall screws

Fastener Centres

Fix at 150mm centres around the sheet perimeter and intermediate joists.

Place fasteners no closer than 12mm from the sheet edge and 18mm from sheet ends.

Jointing and Finishing of EPB Plasterboard

All fastener heads stopped and all sheet joints reinforced with paper jointing tape and stopped. All in accordance with Elephant Plasterboard Installation Guide.

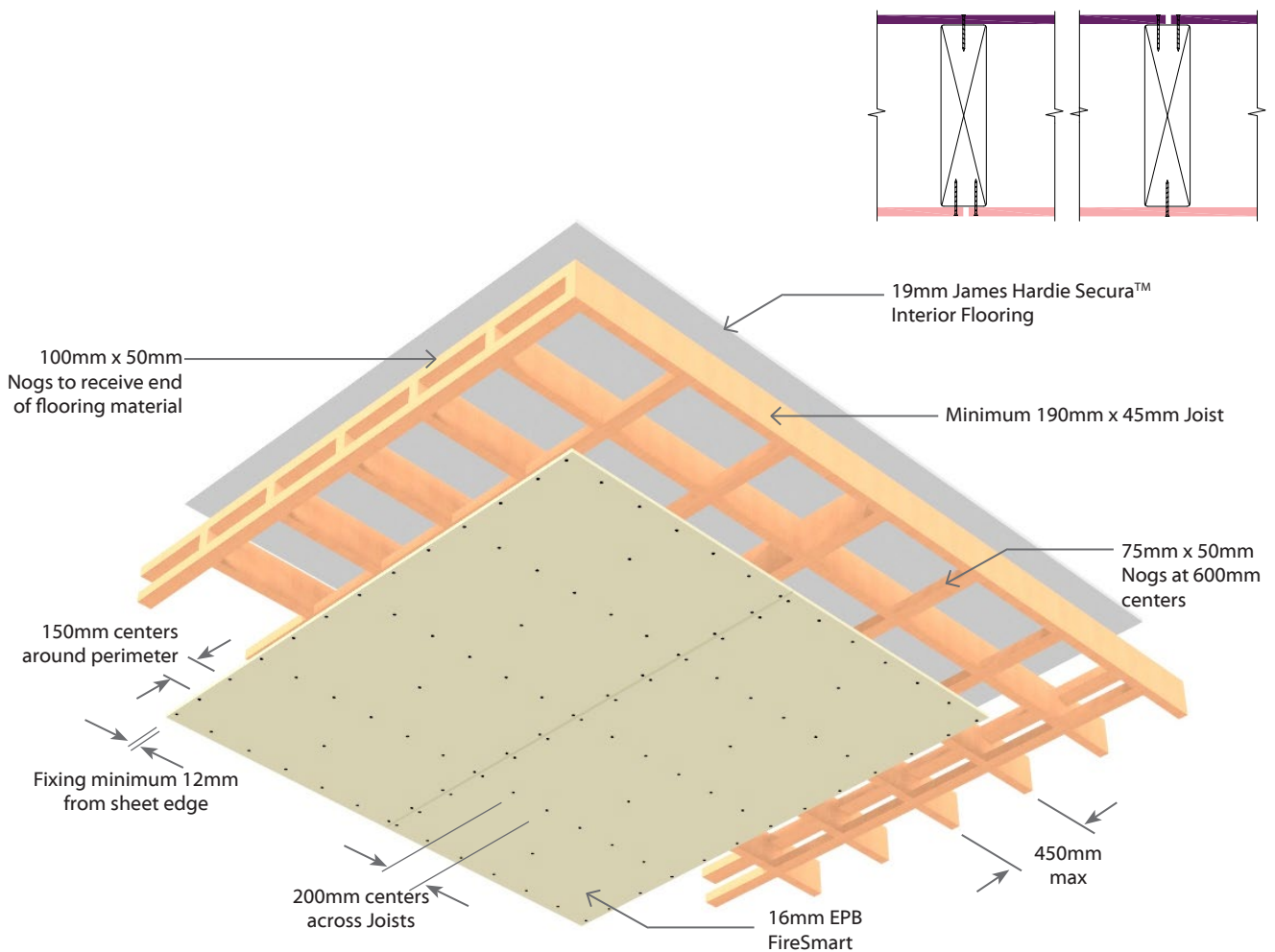

N.B. The above drawings are for illustrative purposes only.





Floating Floor/Ceiling Systems

EFJ2DFA60

EPB & Floating James Hardie Secura™ Interior Flooring

Full Intertency Acoustic

Direct Fix Clip Floating Floor/Ceiling - Timber Joist

Load Bearing

System Number	Lining Suffix	FRR	Load Bearing Ability	Noise Control		Lining Requirement
				STC	IIC*	
EFJ2DFA60	-MS26	60/60/60	LB	67	57-76	1 x 13mm EPB MultiSmart AND 1 x 13mm EPB Standard under the battens
	-M26	60/60/60	LB	68	57-77	2 x 13mm EPB MultiSmart under the battens

Framing

Timber floor joists shall comply with NZS3604 with a minimum depth of 190mm x 45mm and spaced at no more than 450mm centres. Nogs or framing is required at the perimeter of the Fire Rated ceiling.

Alternatively, a proprietary I-joist system may be used subject to specific structural design and approved by the normal building consent process. Consult the joist manufacturer regarding construction of the solid blocking contained in the floor/ceiling to wall junctions.

Initial Floor

Refer to James Hardie Secura™ Interior Flooring Fire Acoustic Floor System Installation Manual. 19mm thick James Hardie Secura™ Interior Flooring laid at right angles to the timber joists in a staggered pattern. Sheet edges other than tongue and groove must be supported over floor joists. When using the site cut sheet pieces, the minimum length of the cut sheet to be used must be 900mm or more.

Adhesive Requirement (Both flooring layers)

A continuous 6mm bead of Adhesive to be applied over the joists or channels before laying the flooring materials.

Suitable Adhesive options are:

- Bostik Seal n Flex-1 or
- Holdfast 220LM or
- Sikaflex 11FC

Fasteners

Initial Secura™ Floor Layer

Fix Secura™ Interior Flooring across the joists using angular grooved galvanised or stainless steel 50 x 2.87mm gun nails or can be screw fixed using a 50mm x 10g timber thread self-embedding screw.

Floating Secura™ Floor Layer

Fix Secura™ Interior Flooring across the Acoustic Channels using 40-45mm x 8-10g self embedding steel screws.

Fastening Centres (Both flooring layers)

Fix at 200mm centres along each joist or channel. Fasteners to be placed at 25mm min at long sheet edges and 12mm from transverse edges. Fastener edge distance of 50mm to be maintained at sheet corners.

Flooring Void

James Hardie Acoustic Cradles are to be positioned on the James Hardie Secura™ Interior Flooring at 450mm centres max starting from the edge of the room. The Acoustic Cradles need not be aligned with the timber floor joists and can be laid in either direction.

The Cradles are not to be fixed down to the bottom flooring layer.

James Hardie Acoustic Channels to be placed inside the Acoustic Cradles. Acoustic Channels are spaced at 450mm centres maximum.

Flooring Void Sound Absorber

Install Sound Absorber between the James Hardie Acoustic Floor Channels. Use 50mm thick R1.2 glass wool blanket with a minimum density of 9.6kg/m³.

Floating Floor

James Hardie Secura™ Interior Flooring to be laid at right angles to the Acoustic Channels and fixed at 200mm centres along the channel. Lay the sheets in a staggered pattern. Flooring edges other than tongue and groove must be supported by channels.

Allow 5-8mm gap between Secura™ Interior Flooring and the external/ internal walls. Fill the gaps with an acoustic sealant.

Acoustic Clip and Battens

Fasten the Acoustic Clip to the joists at 1200mm centres max (and not less than 900mm centres) to support the metal ceiling battens.

Metal battens are spaced at 600mm centres maximum.

Ceiling Void Sound Absorber

Install Sound Absorber between the joists above the metal ceiling battens. Use minimum 75mm thick R1.8 glass wool blanket with a minimum density of 9.6kg/m³.

EPB Plasterboard Ceiling Lining

Two layers of EPB Plasterboard as per specified system above fixed at right angles directly to the underside of the metal battens. All sheet end butt joints shall occur on the battens. Offset the outer layer by 600mm from the inner layer. Sheet joints should be touched fitted.

Fixing of EPB Plasterboard Internal Linings

Fasteners (As per Specified System Above)

System Number	1 st Layer	2 nd Layer
		Self-Tapping Drywall Screws
EFJ2DFA60-MS26	13mm	13mm
EFJ2DFA60-M26	25 x 6g	41 x 6g

Fastening Centres

Ceiling sheets shall be fixed at 200mm centres along each metal ceiling batten with butt edges fixed at 100mm centres.

Fasteners to be placed no closer than 12mm from sheet edge.

Avoid outer layer screws from hitting inner layer screws.

Acoustic Sealant

A bead of fire retardant Acoustic Sealant must be applied around the perimeter of the first layer and the second layer bedded on the bead.

Wall/Ceiling Junction

The internal angle between the ceilings and walls must be protected by Cornice or square stopped corners taped and filled in accordance with Elephant Plasterboard Installation Guide.

Jointing

Inner layer: Unstopped.

Outer Layer: All fastener heads stopped and all sheet joints reinforced with paper jointing tape and stopped in accordance with the publication entitled Elephant Plasterboard Installation Guide.

Additional Reference Material

Refer to James Hardie Secura™ Interior Flooring Installation Manual and the James Hardie Fire and Acoustic Floor System Installation Manual for additional information covering general and wet area installation and penetrations and control joints.

***Impact Insulation Class (IIC)**

IIC of 57 is achieved with a bare floor.

IIC of 58 is achieved with loose laid Vinyl.

IIC of 75 is achieved with 40oz loop pile carpet on 8mm foam chip underlay.

IIC of 76 is achieved with 40oz loop pile carpet on waffle underlay.



EFJ2DFA60

EPB & Floating James Hardie Secura™ Interior Flooring

Full Intertency Accoustic

Direct Fix Clip Floating Floor/Ceiling - Timber Joist

Load Bearing

Structural Detail

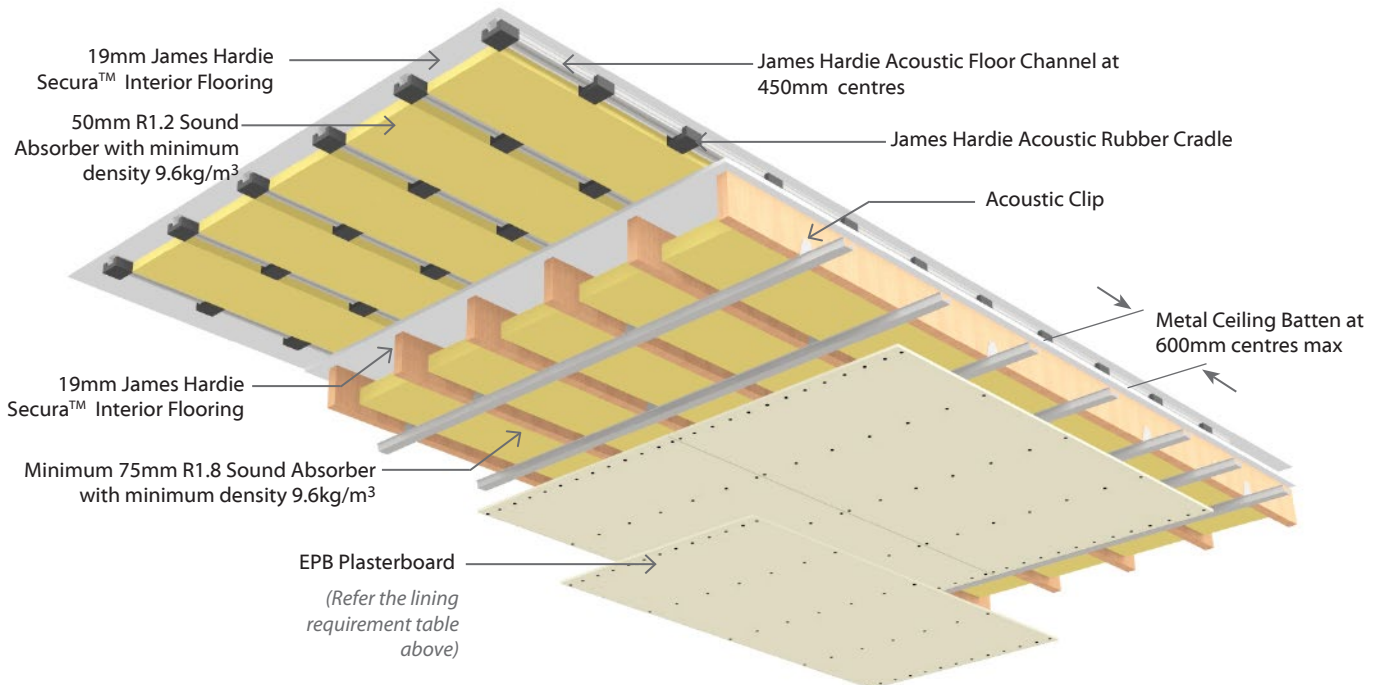
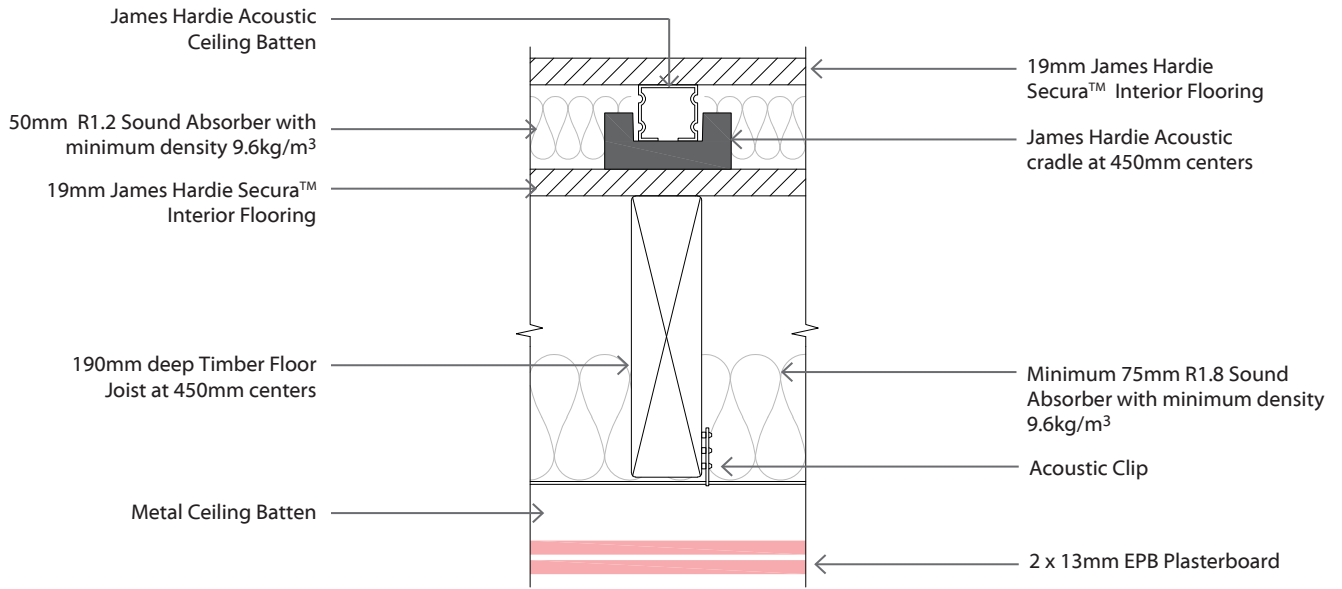

N.B. The above drawings are for illustrative purposes only.





Construction Details

Boundary Wall & Post Fire Stability

Post Fire Stability

The fire rated walls built close to boundary are required to achieve post fire stability as per section 2.2.4 of B1/VM1 of the NZBC.

The bottom plate of these walls can be fixed in accordance with the table shown below using Pryda® Brace Anchor or any equivalent hold downs on either side of the stud. These fixings ensure that when a boundary wall is exposed to post fire face loads, it doesn't collapse in any direction. Contact the project structural engineer for an alternate design to achieve post fire stability if the published solutions are not suitable for the project.

Note: Post fire stability for steel framing must be as per SED.

Framing

The frame sizes and spacing mentioned in this manual are a minimum requirement. Bigger framing sections required to suit a proprietary cladding system or to suit higher wind pressures, will not affect the FRR, provided that the other system requirements presented in this manual are adhered to.

Higher levels of timber treatments or steel coating to enhance their durability will not alter the fire or acoustic performance of the systems. Sheet set-out must be determined by the designer including the location of all expansion and control joints to enable correct framing set-out (these must be in accordance with the relevant James Hardie product literature).

CONCRETE FOUNDATION				
Wall Height max (mm)	2400	3000	3000	3700
Bottom Plate (mm)	90 x 45	90 x 45	140 x 45	140 x 45
Stud Spacing max (mm)	400	300	600	400
Nog Spacing (mm)	800	800	800	800
Hold Down brackets	Pryda® Bracing Anchor or any equivalent hold downs to both sides of the stud			

BLOCK WALL FOUNDATION		
Wall Height max (mm)	3000	3700
Bottom Plate (mm)	140 x 45	140 x 45
Stud Spacing max (mm)	600	400
Nog Spacing (mm)	800	800
Hold Down brackets	Pryda® Bracing Anchor or any equivalent hold downs to both sides of the stud	

TIMBER FOUNDATION			
	Joist parallel	Joist Perpendicular	
Joist min (mm)	190	190	190
Wall Height max (mm)	2700	2700	3700
Bottom Plate (mm)	140 x 45	140 x 45	140 x 45
Stud Spacing max (mm)	600	600	300
Nog Spacing max (mm)	800	800	800
Hold Down brackets	Pryda® Bracing Anchor or any equivalent hold downs to both sides of the stud		

*For higher stud heights, contact Elephant Plasterboard



EFC-001

Boundary Wall Bottom Plate Fixing - Concrete Foundation

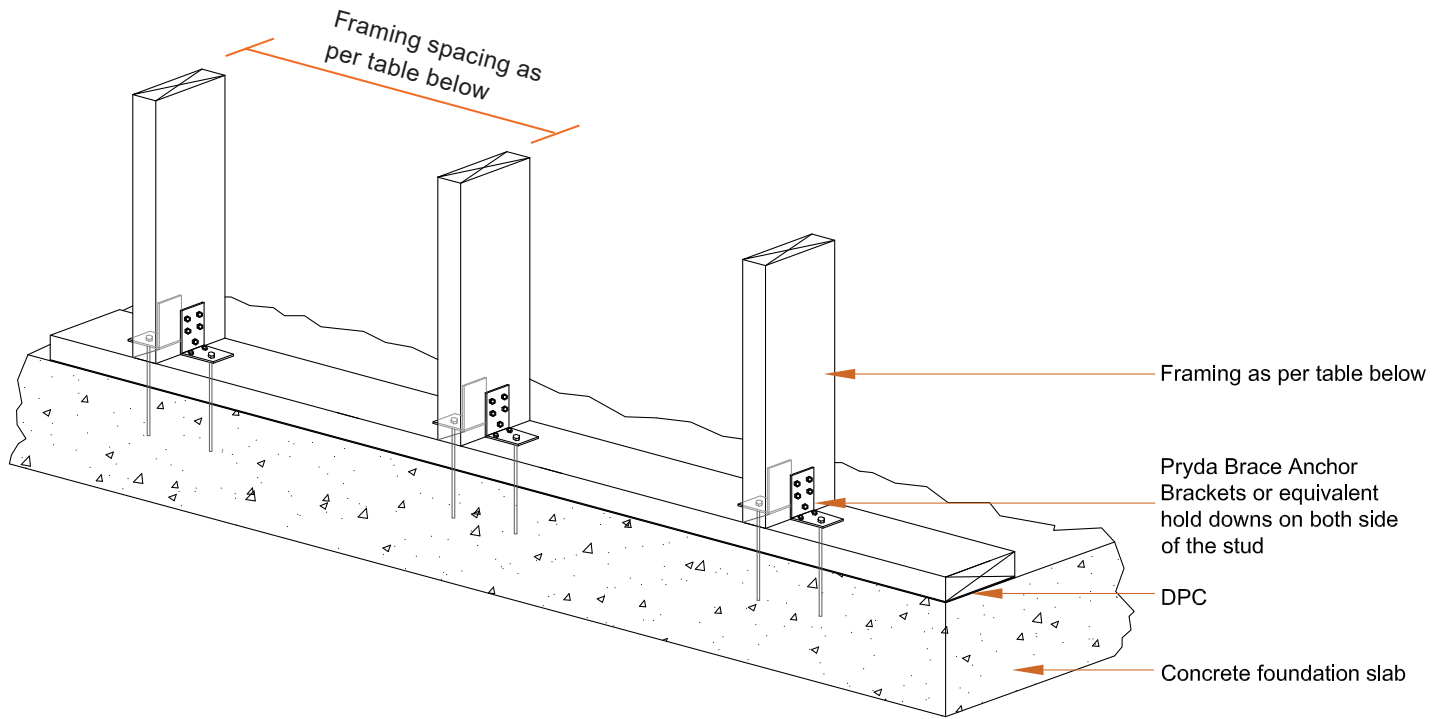

Note:

This detail is only indicative, confirmation will be required by a structural engineer for stability NZBC B1 by designer. Elephant plasterboard (NZ) Ltd accepts no liability if not verified by an engineer

Wall Height max (mm)	2400	3000	3000	3700
Bottom Plate (mm)	90 x 45	90 x 45	140 x 45	140 x 45
Stud Spacing max (mm)	400	300	600	400
Nog Spacing (mm)	800	800	800	800
Hold Down brackets	Pryda® Brace Anchor or equivalent hold downs to both sides of each Stud			



EFC-002

Post Fire Stability - Concrete Foundation

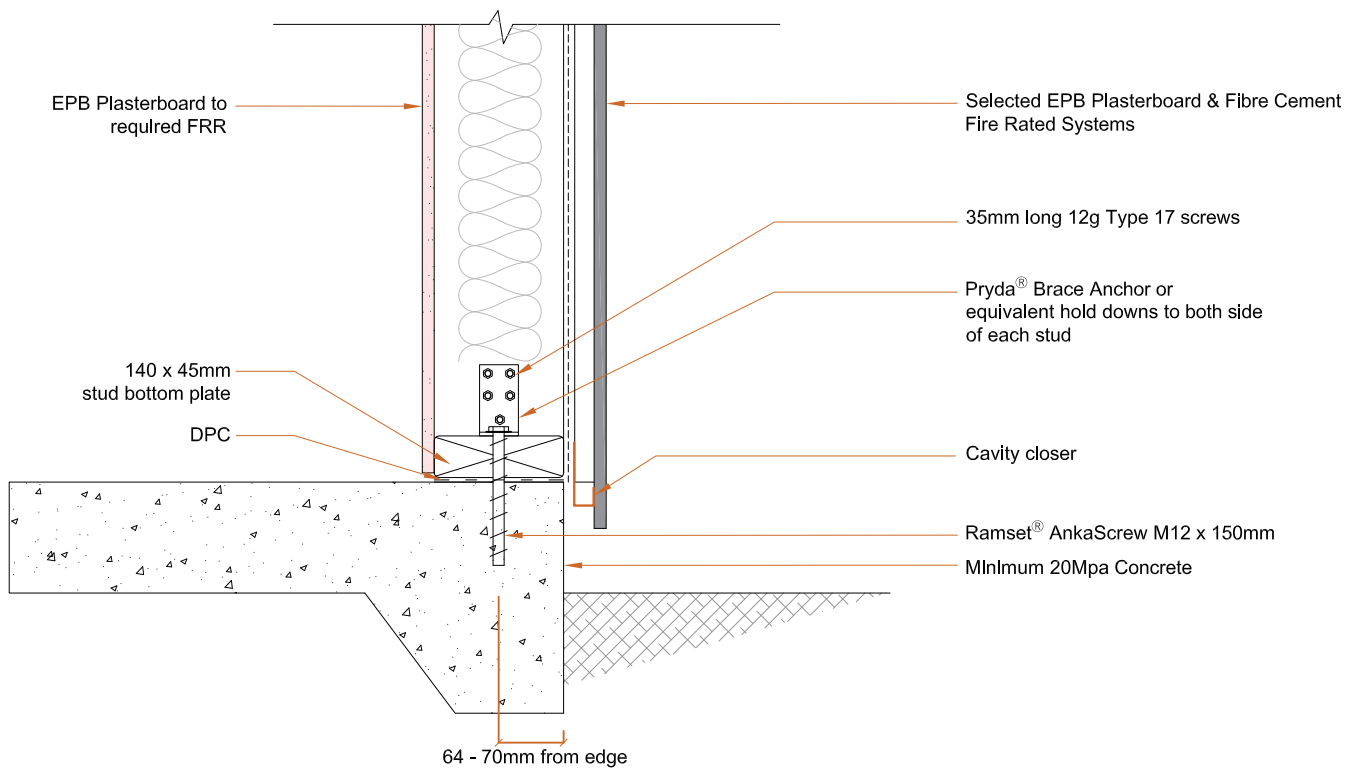
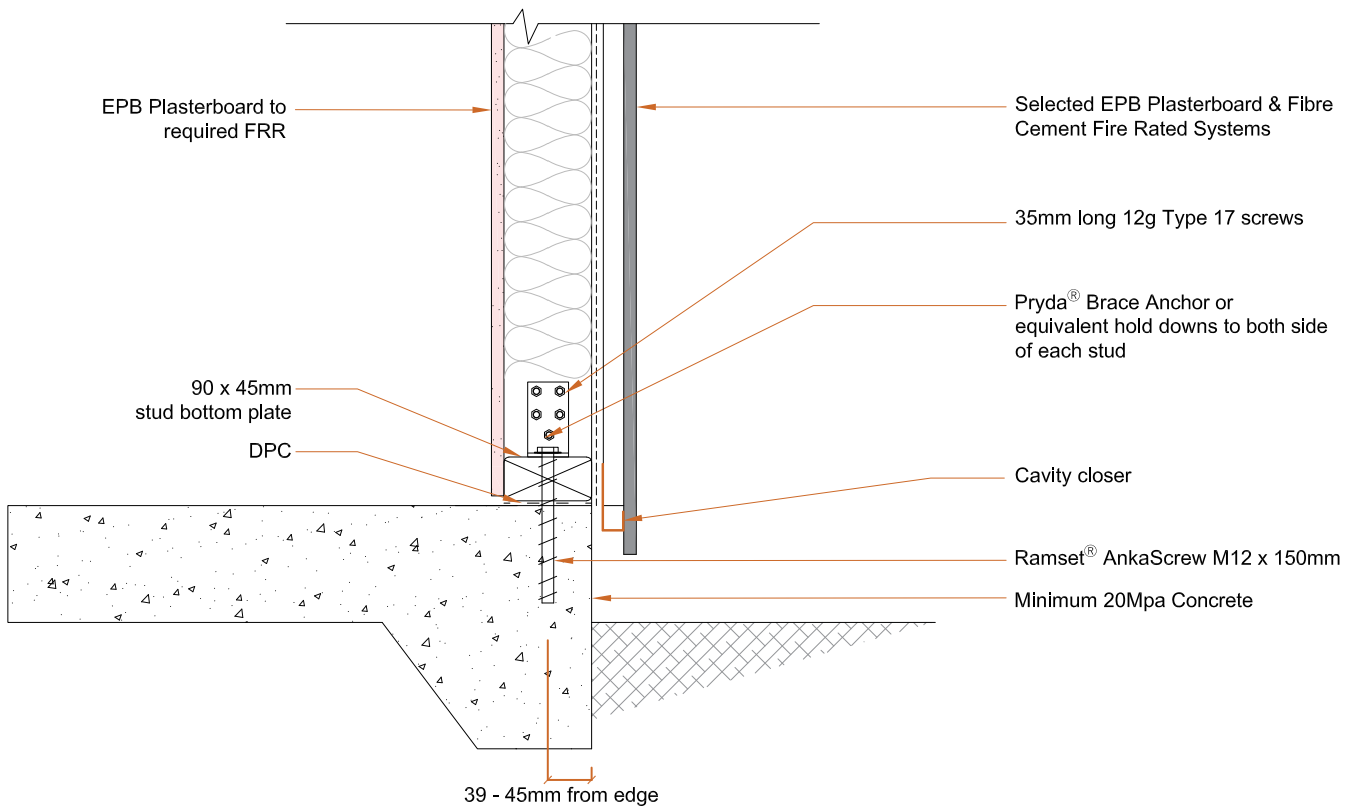

Wall Height max (mm)	2400	3000	3000	3700
Bottom Plate (mm)	90 x 45	90 x 45	140 x 45	140 x 45
Stud Spacing max (mm)	400	300	600	400
Nog Spacing (mm)	800	800	800	800
Hold Down brackets	Pryda [®] Brace Anchor or equivalent hold downs to both sides of each Stud			



EFC-003

Post Fire Stability - Block wall Foundation

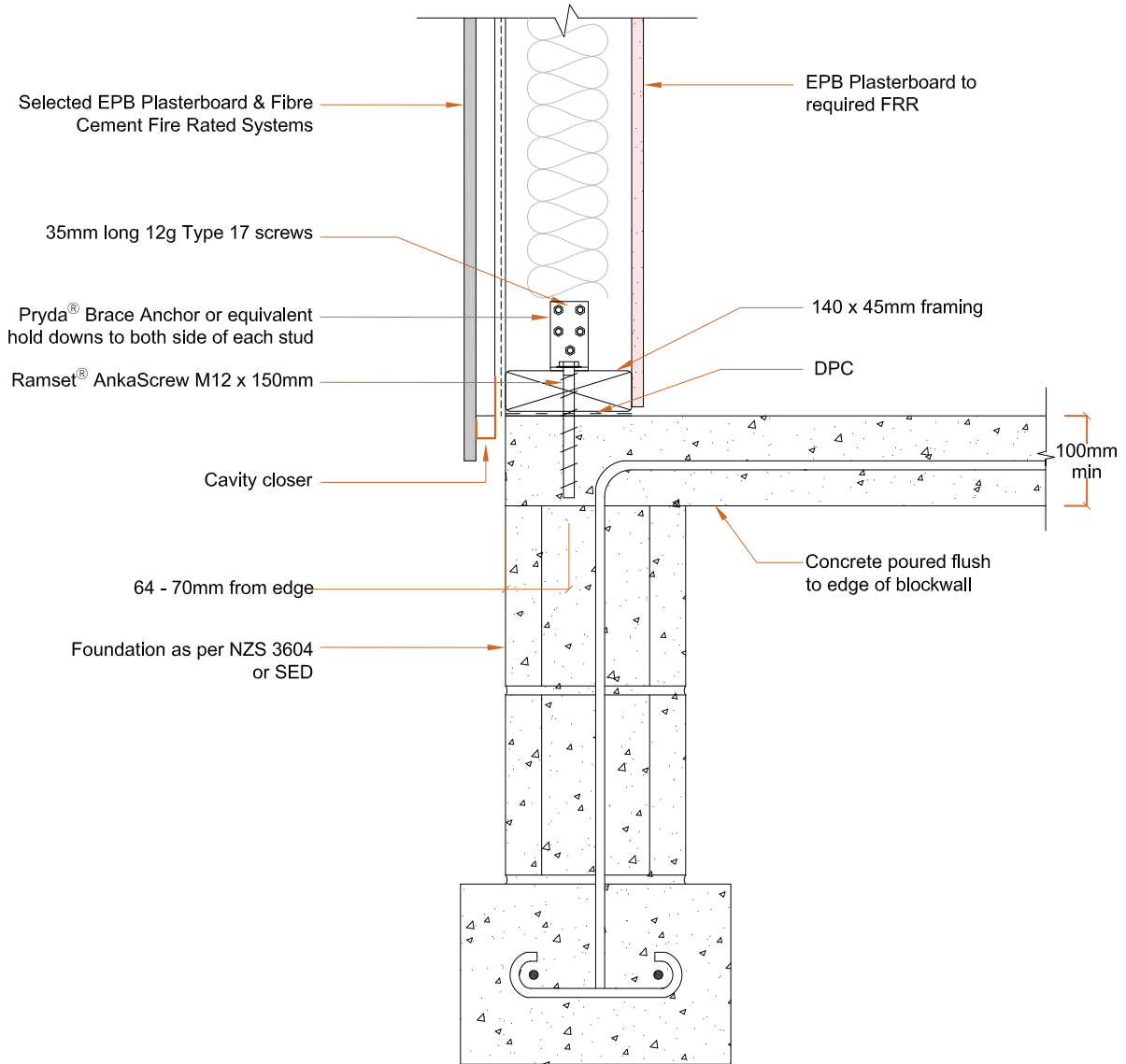

Wall Height max (mm)	3000	3700
Bottom Plate (mm)	140 x 45	140 x 45
Stud Spacing max (mm)	600	400
Nog Spacing max (mm)	800	800
Hold Down brackets	Pryda® Brace Anchor or equivalent hold downs to both sides of each Stud	



EFC-004

Post Fire Stability - Timber Foundation

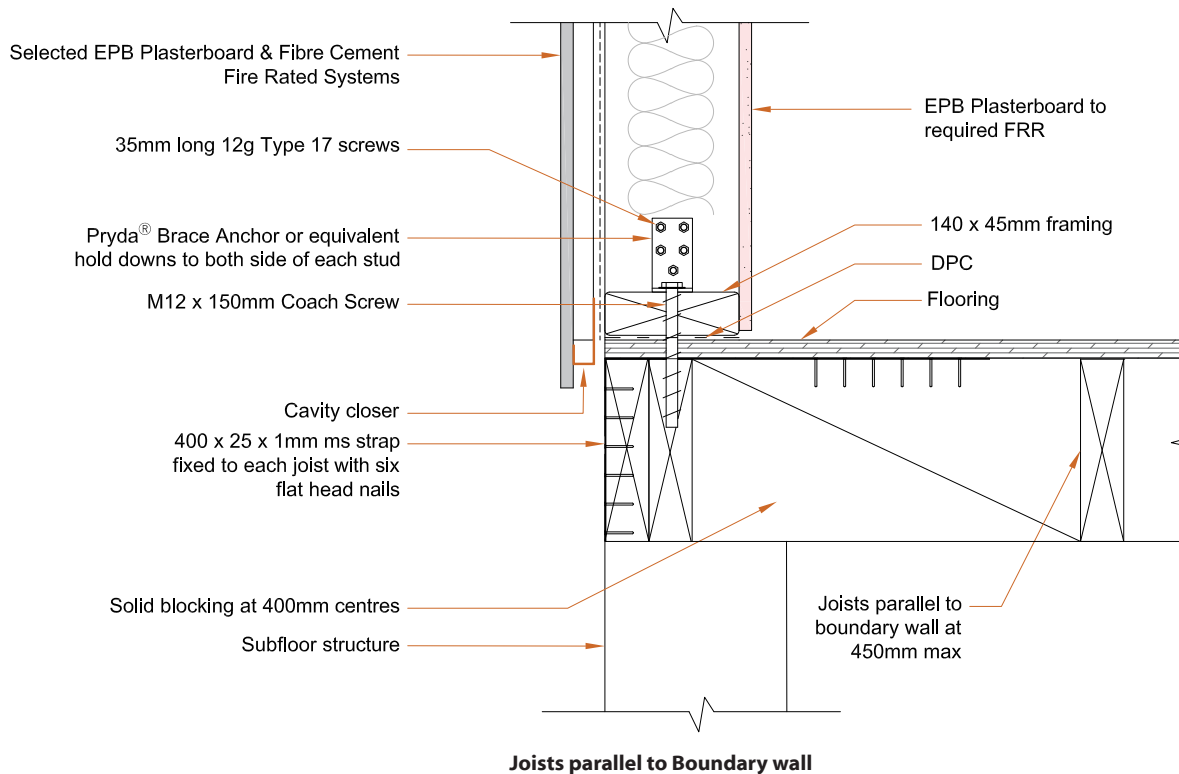
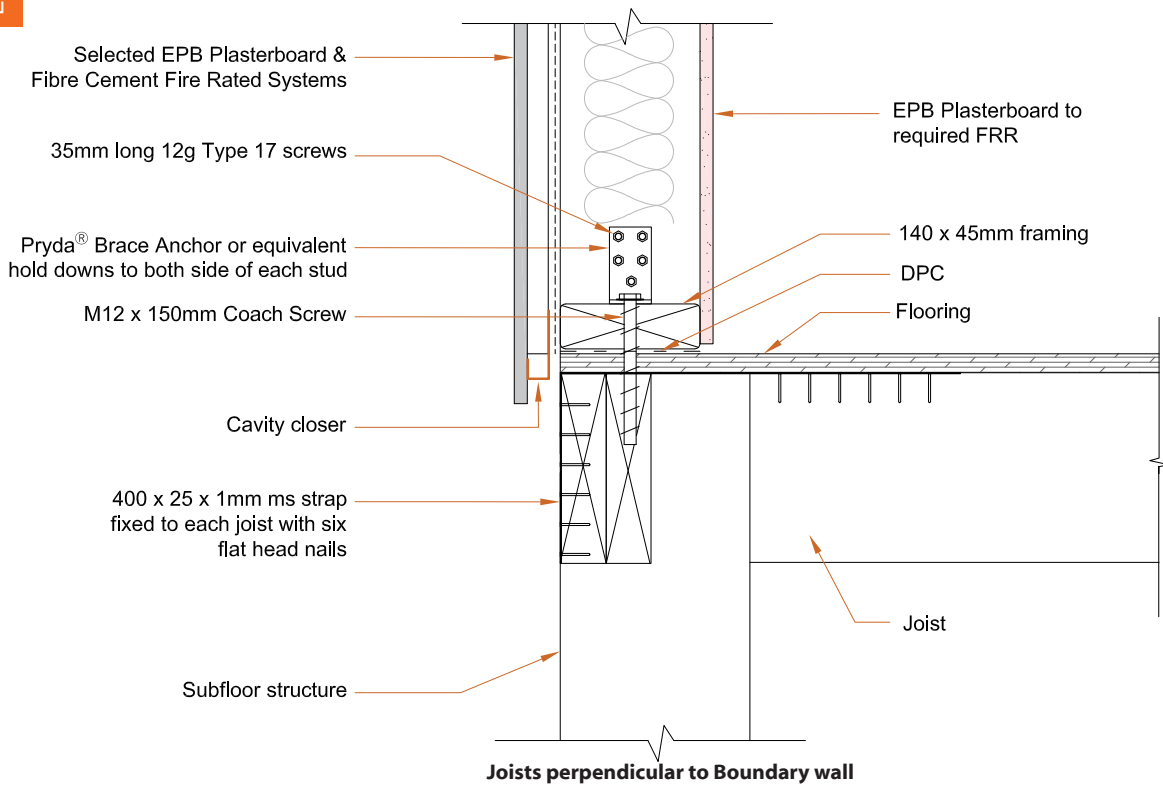

	Joist Perpendicular		Joist Parallel
Wall Height max (mm)	2700	3700	2700
Bottom Plate (mm)	140 x 45	140 x 45	140 x 45
Stud Spacing max (mm)	600	300	600
Nog Spacing max (mm)	800	800	800
Joist min (mm)	190	190	190
Hold Down brackets	Pryda® Brace Anchor or equivalent hold downs to both sides of each Stud		



EFC-006

Soffit Detail

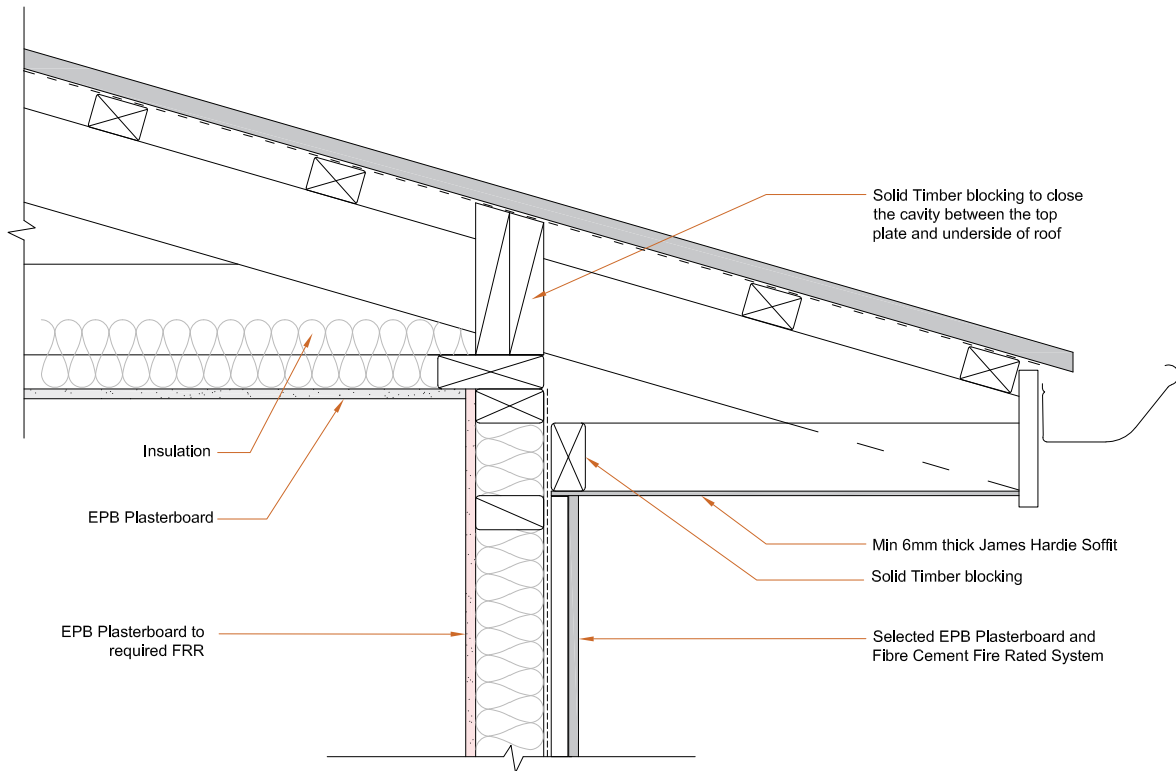

EFC-005

Soffit Detail - 2

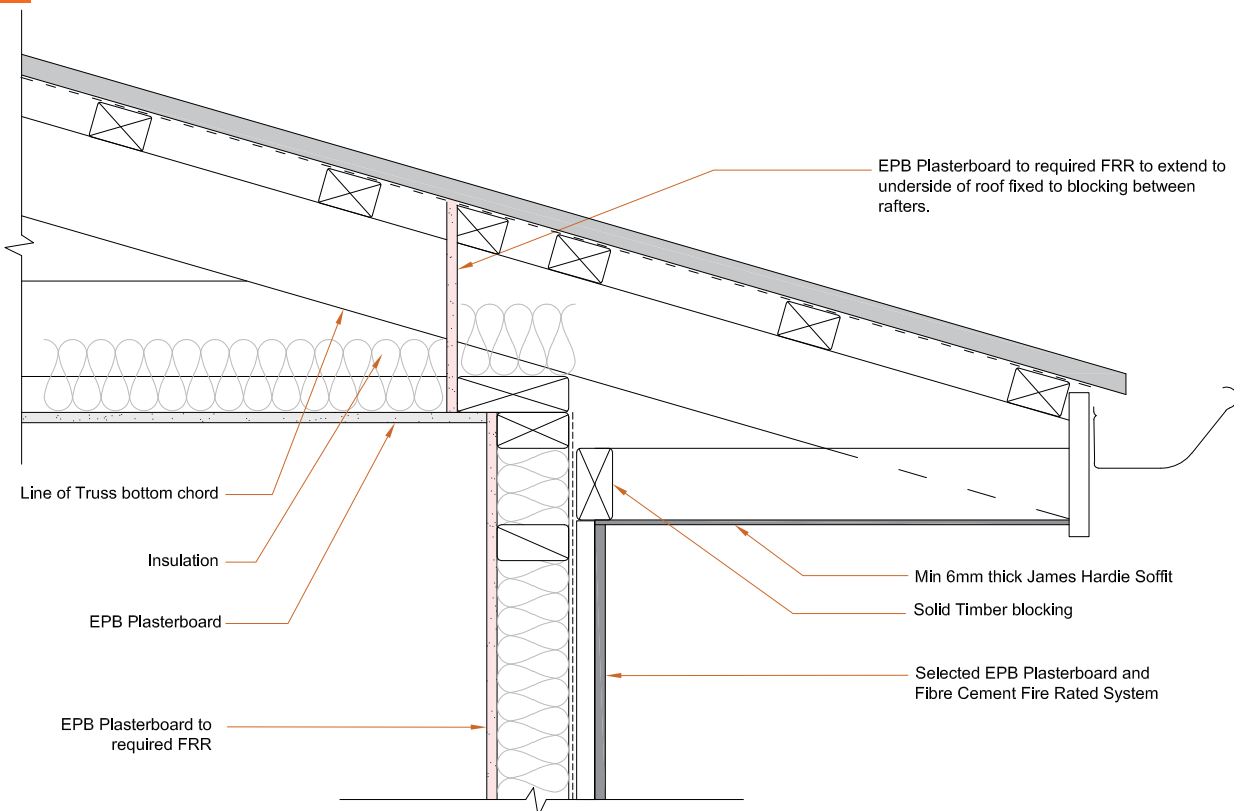

EFC-007

NIL Soffit Detail

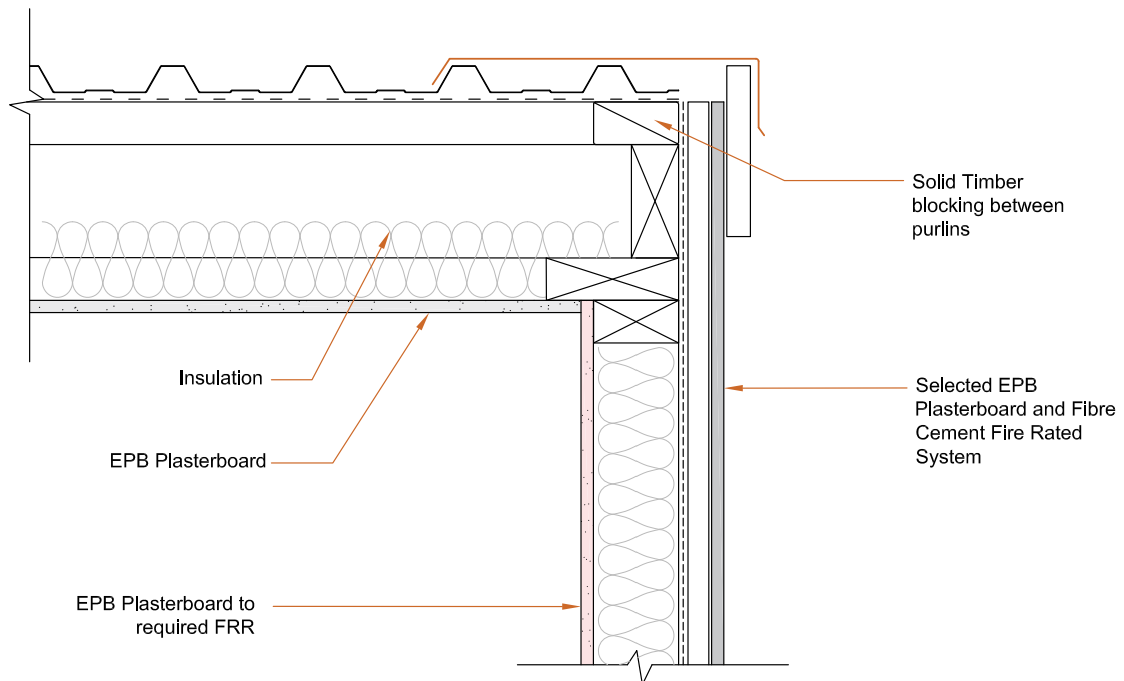
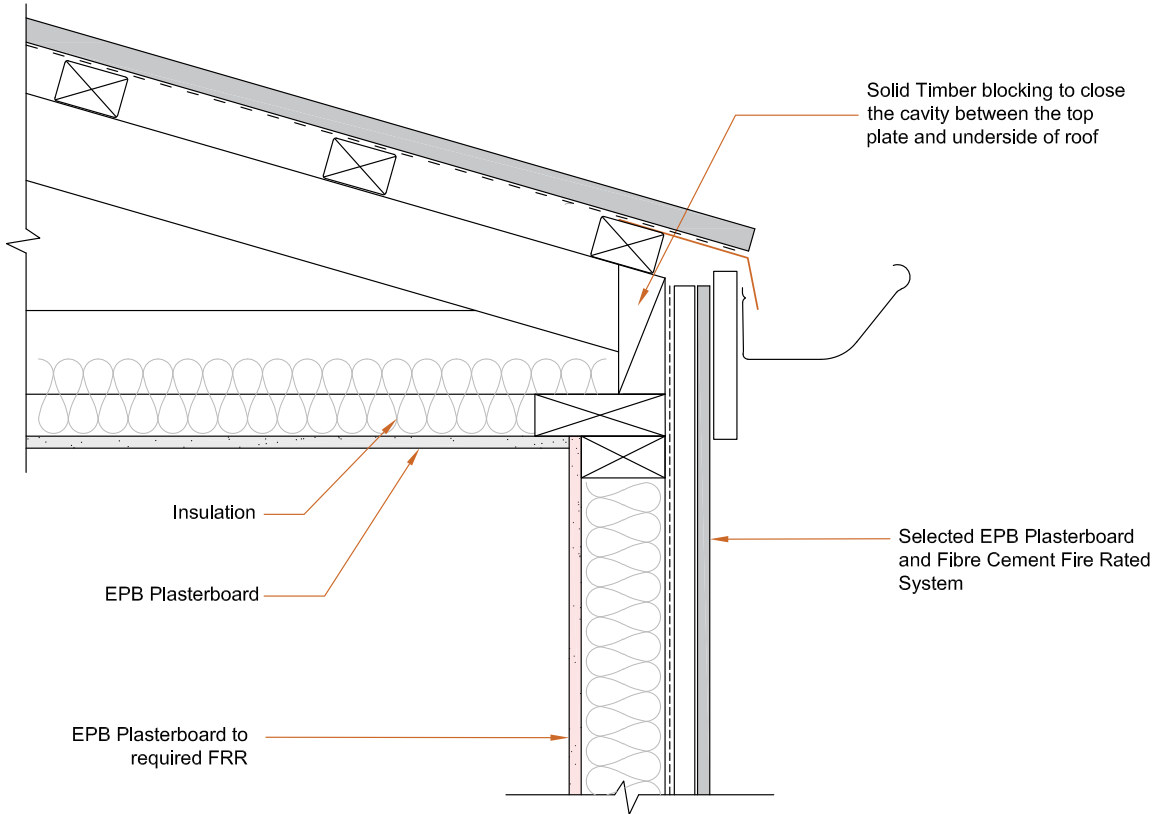

EFC-009

Timber Floor to Floor Intertency Wall Junction

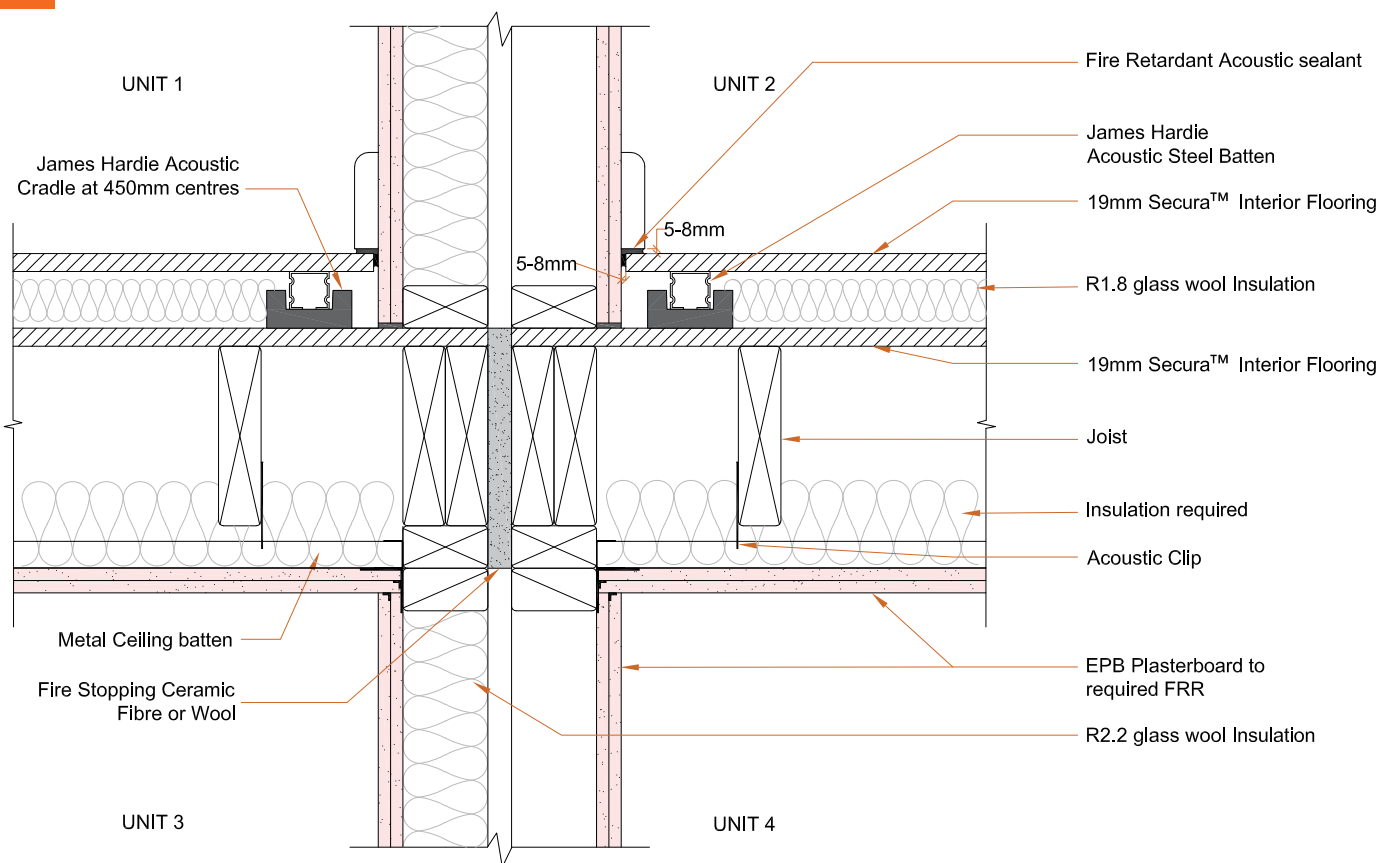

EFC-008

Concrete Slab to Timber Intertency Wall Junction

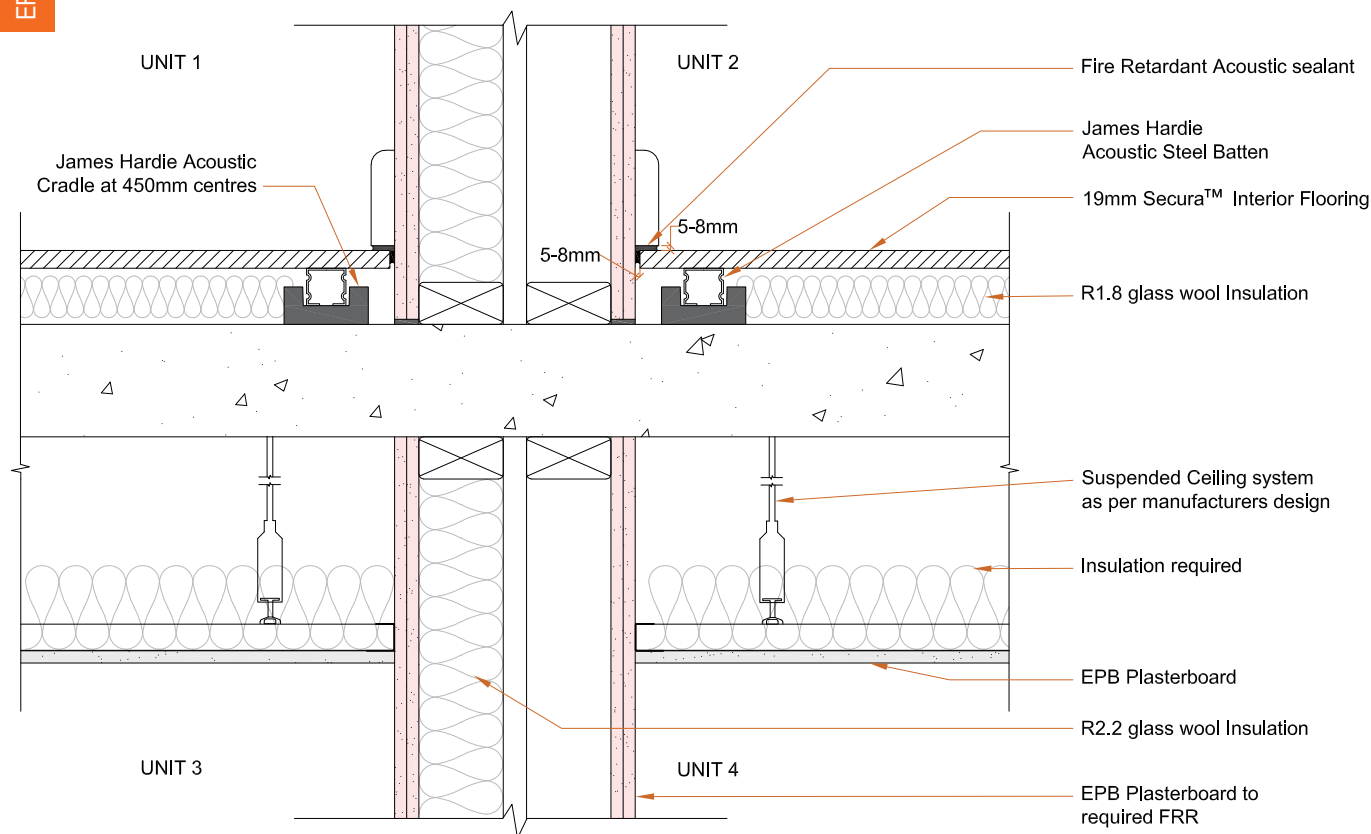

EFC-010

Split Level Floor to Intertency Wall Junction

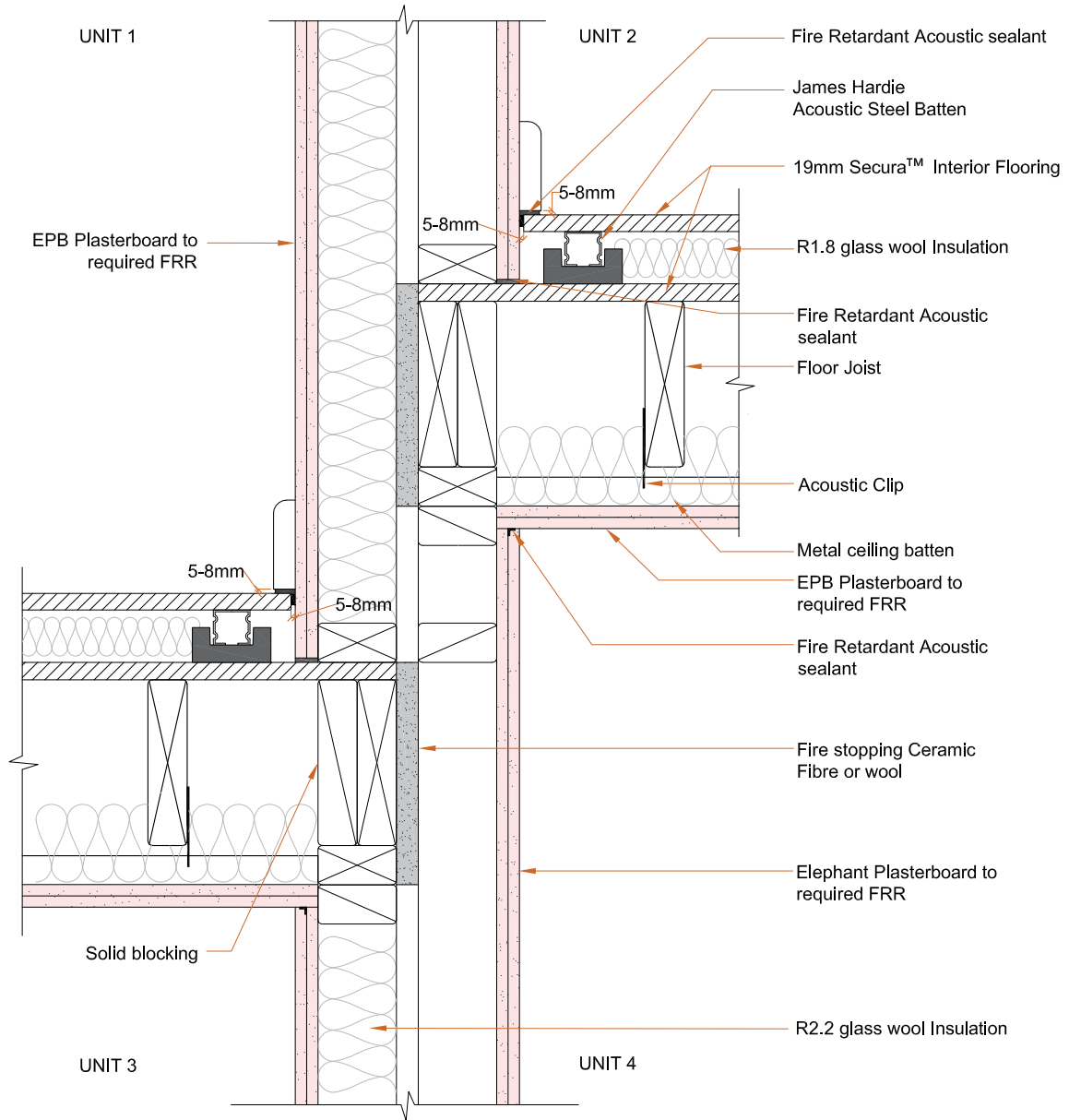

EFC-011

Intertency Fire Separation

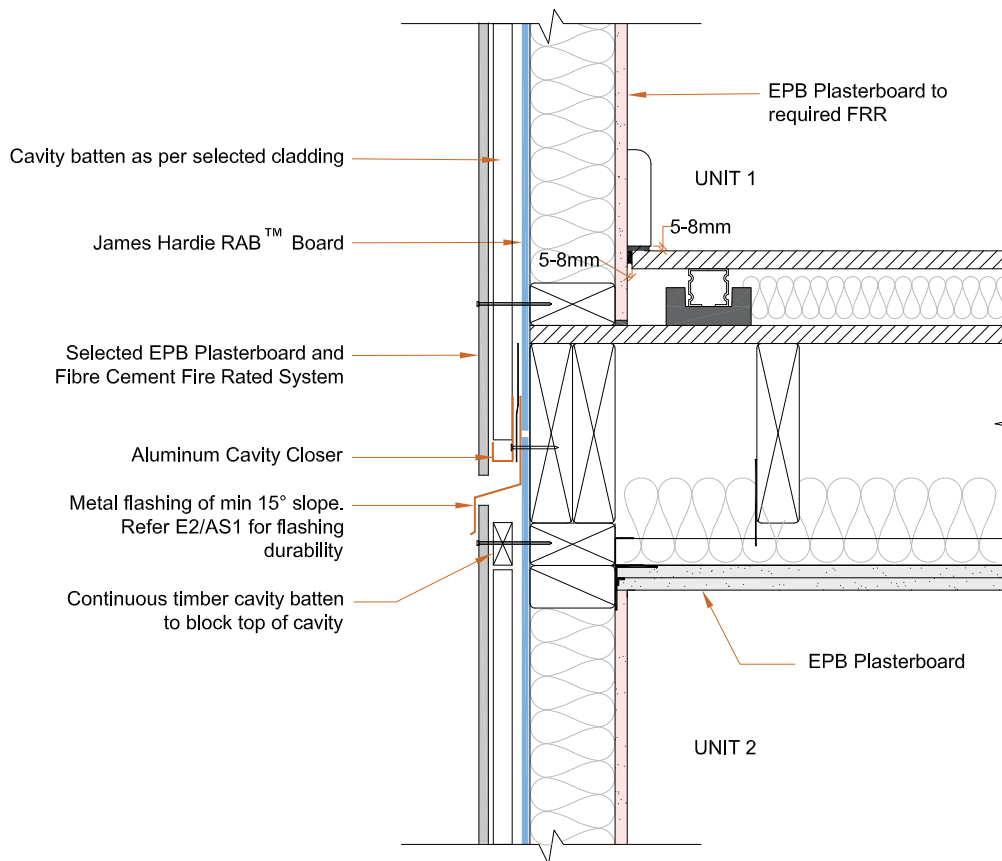

EFC-012

Intertency Wall to External Wall Junction

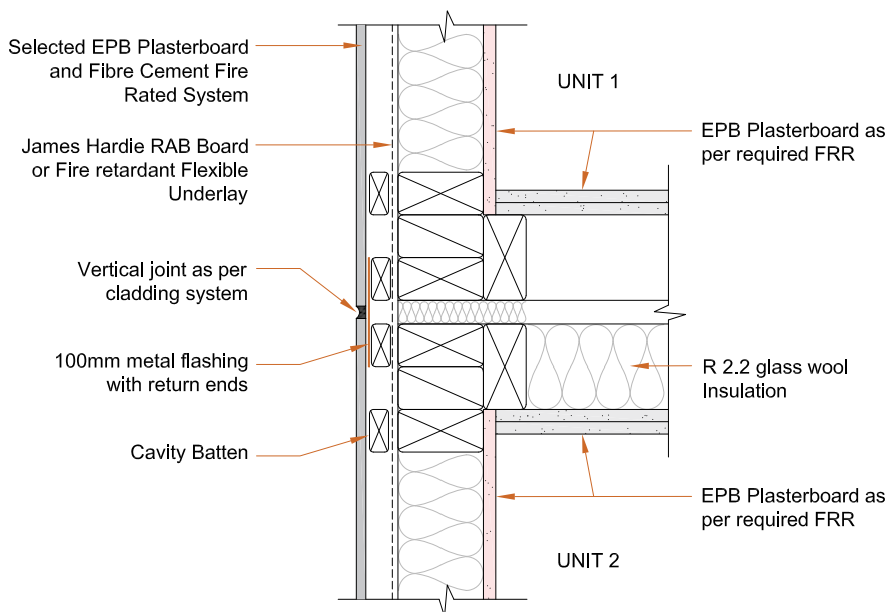

EFC-013

Single Timber Frame Wall to External Wall Junction

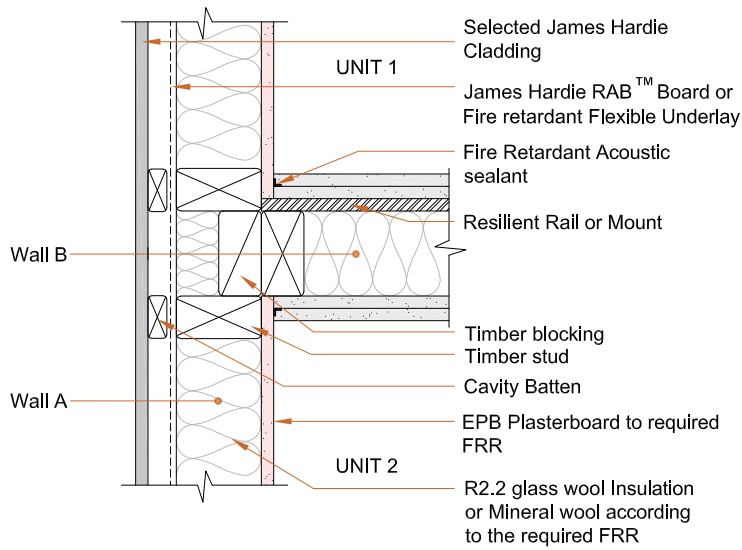

For Systems where the difference in FRR between Wall A & B is 30 minutes or less

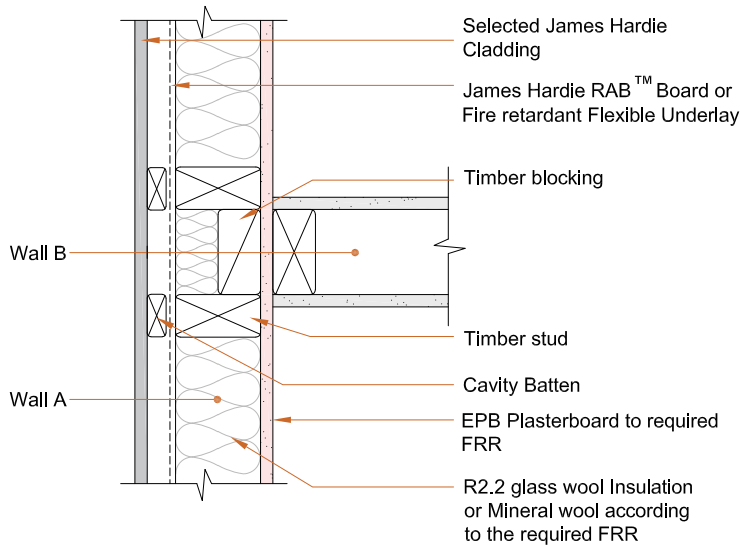

For Systems where the difference in FRR between Wall A & B is higher than 30 minutes, the lining of wall with higher FRR is continuous (Wall A in this example)



EFC-014

Fire Cell Extension

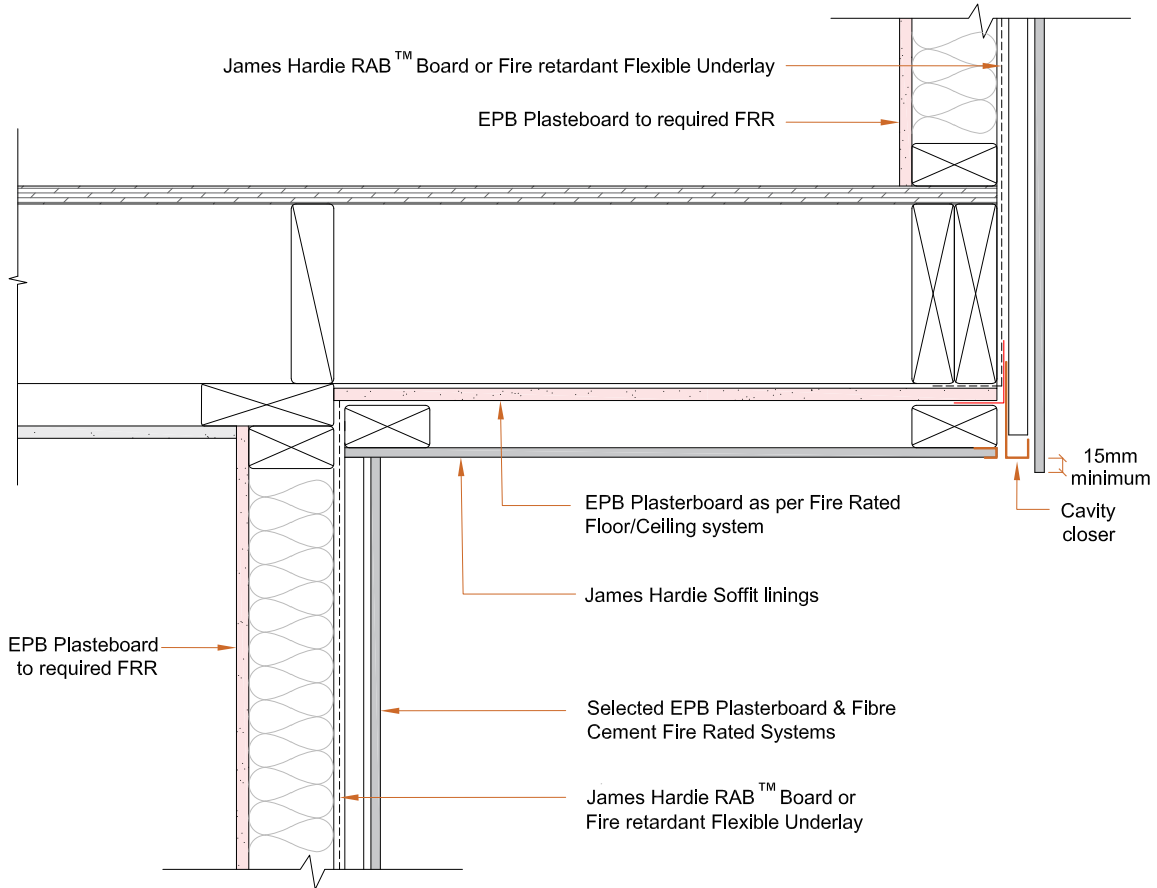

EPB Plasterboard Product Range

Product Weights and available Lengths

THICK-NESS	ELEPHANT PLASTERBOARD PRODUCT RANGE	EDGE TYPE	WIDTH	WEIGHT	LENGTH							
					2.4m	2.7m	3.0m	3.3m	3.6m	4.2m	4.8m	6.0m
mm			mm	Kg per m ²								
10	Standard	TE/TE	1200	6.9	✓	✓	✓	✓	✓	✓	✓	✓
10	Standard Horizontal	TE/SE	1200	6.9	✓		✓		✓	✓	✓	✓
10	Standard Horizontal - Wide	TE/SE	1350	7.4					✓		✓	✓
13	Standard	TE/TE	1200	8.8	✓	✓	✓	✓	✓	✓	✓	✓
10	CeilingSmart	TE/TE	1200	7.4	✓	✓	✓		✓		✓	✓
10	FireSmart	TE/TE	1200	7.4	✓	✓	✓		✓		✓	✓
13	FireSmart	TE/TE	1200	11.7	✓	✓	✓	✓	✓			
16	FireSmart	TE/TE	1200	14.7	✓	✓	✓					
10	MultiSmart	TE/TE	1200	9.0	✓	✓	✓		✓		✓	
10	MultiSmart Horizontal	TE/SE	1200	9.0	✓						✓	
13	MultiSmart	TE/TE	1200	12.1	✓	✓	✓	✓	✓			
10	AquaSmart	TE/TE	1200	8.3	✓	✓	✓		✓			
10	AquaSmart Horizontal	TE/SE	1200	8.3	✓						✓	
13	AquaSmart	TE/TE	1200	11.7	✓	✓	✓		✓			

TE/TE = Tapered Both Edges

TE/SE = Tapered One Edge, Square the Other

Product Primary Functions*

THICK-NESS	ELEPHANT PLASTERBOARD PRODUCT RANGE	EDGE TYPE	WIDTH	Horizontal Fixing	Span 600 Centres on Ceilings	Bracing	Fire Resistance	Noise Control	Impact Resistant	Water Resistant
10	Standard	TE/TE	1200			✓	✓			
10	Standard Horizontal	TE/SE	1200	✓		✓				
10	Standard Horizontal -Wide	TE/SE	1350	✓		✓				
13	Standard	TE/TE	1200		✓		✓			
10	CeilingSmart	TE/TE	1200		✓	✓	✓			
10	FireSmart	TE/TE	1200		✓	✓	✓			
13	FireSmart	TE/TE	1200		✓	✓	✓	✓	✓	
16	FireSmart	TE/TE	1200				✓	✓	✓	
10	MultiSmart	TE/TE	1200		✓	✓	✓	✓		
10	MultiSmart Horizontal	TE/SE	1200	✓		✓				
13	MultiSmart	TE/TE	1200		✓	✓	✓	✓	✓	
10	AquaSmart	TE/TE	1200				✓	✓		✓
10	AquaSmart Horizontal	TE/SE	1200	✓						✓
13	AquaSmart	TE/TE	1200		✓		✓	✓		✓

* The above table details the product's Primary functions.

Some products may perform more than the functions indicated



EPB Plasterboard Product Range

10mm EPB Standard

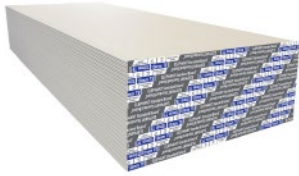

10mm EPB Horizontal Standard



13mm EPB Standard



10mm EPB FireSmart/CeilingSmart



13mm EPB FireSmart



16mm EPB FireSmart



10mm EPB MultiSmart



10mm EPB Horizontal MultiSmart



13mm EPB MultiSmart



10mm EPB AquaSmart



10mm EPB Horizontal AquaSmart



13mm EPB AquaSmart



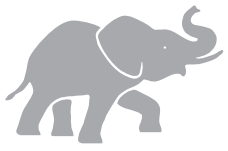

Elephant
Plasterboard

FOR MORE INFORMATION

EMAIL info@elephantplasterboard.co.nz

CALL 0800 353 742