



EDGESMITH

NICKS

Vertical Angle Picket Panel

PRODUCT CODE:

NICKS-1.8

MATERIAL:

- Aluminium
- Pickets 40 x 3 Equal Angle
- Rails 40 x 40 x 2.0mm

FINISH:

Powder Coated

WEIGHT:

36 kg

FIXINGS SUPPLIED:

- Brackets
- Tek Screws

RECOMMENDED POST :

- Fence Post Inground
2.6mH 65 x 2.5mm SHS Ali
- Fence Post Flanged
1.9mH 65 x 2.5mm SHS Ali



For more information scan the QR code

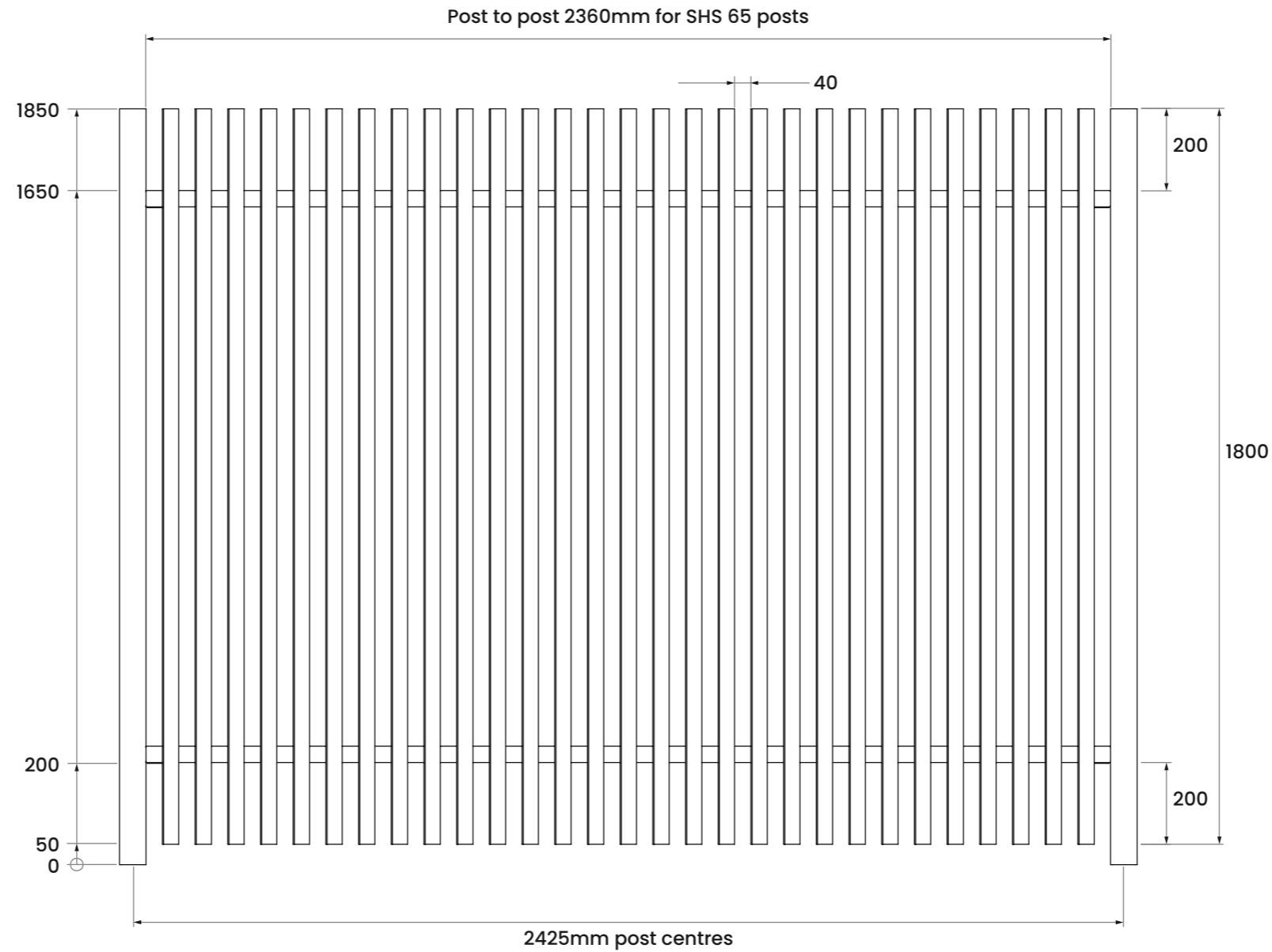

Fixings

- On Concrete:
M12 x 75 Sleeve Anchor
- On Structural Timber:
M12 x 75 Coach Bolt

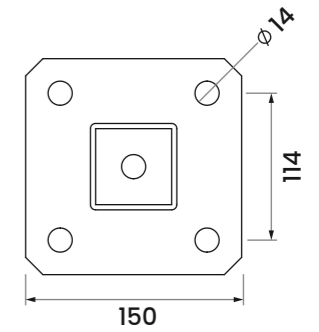

Flange Post

Post Size: SHS 65mm
Flange Thickness: 10mm

Inground Post

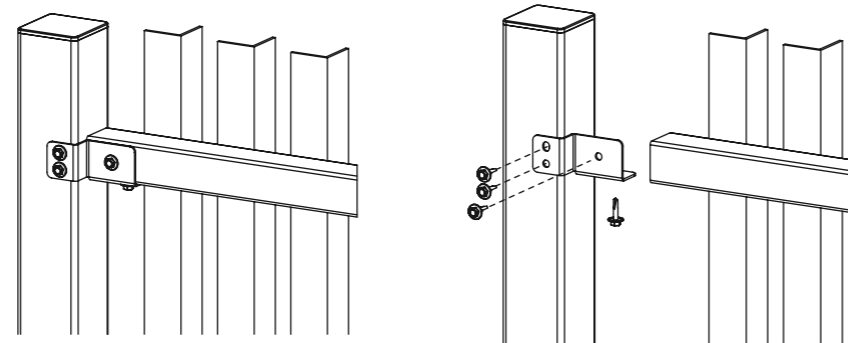
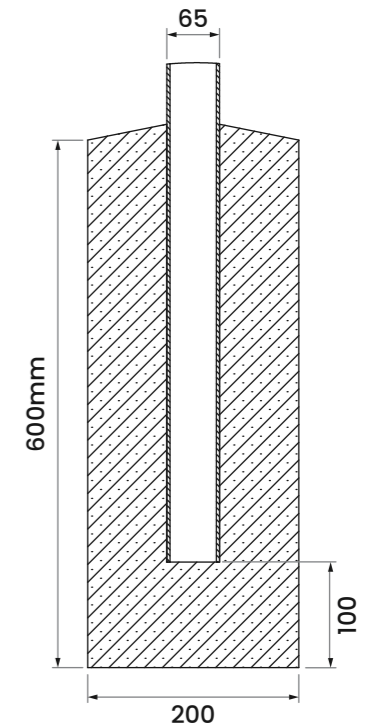

Rail Bracket Detail

