



EDGESMITH

NGARU MESH

358 Rigid Wire Security Fencing

PRODUCT CODE:

358N-1.8-HPCB

MATERIAL:

HDG Rigid Wire 3.8mm Dia

FINISH:

Powder Coated Black

SHEET WEIGHT:

10kg/sqm

RECOMMENDED POST:

Steel 65 SHS x 2.5mm

FIXINGS REQUIRED:

Ordered Separately

- Mesh Clips
- Security Screws



For more information scan the QR code

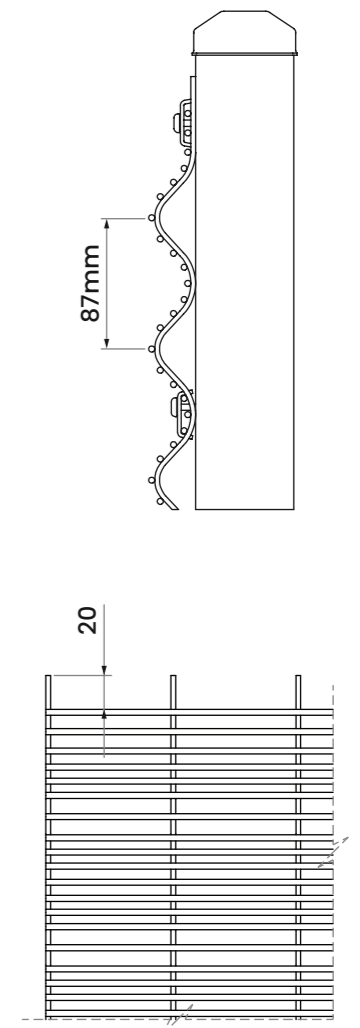
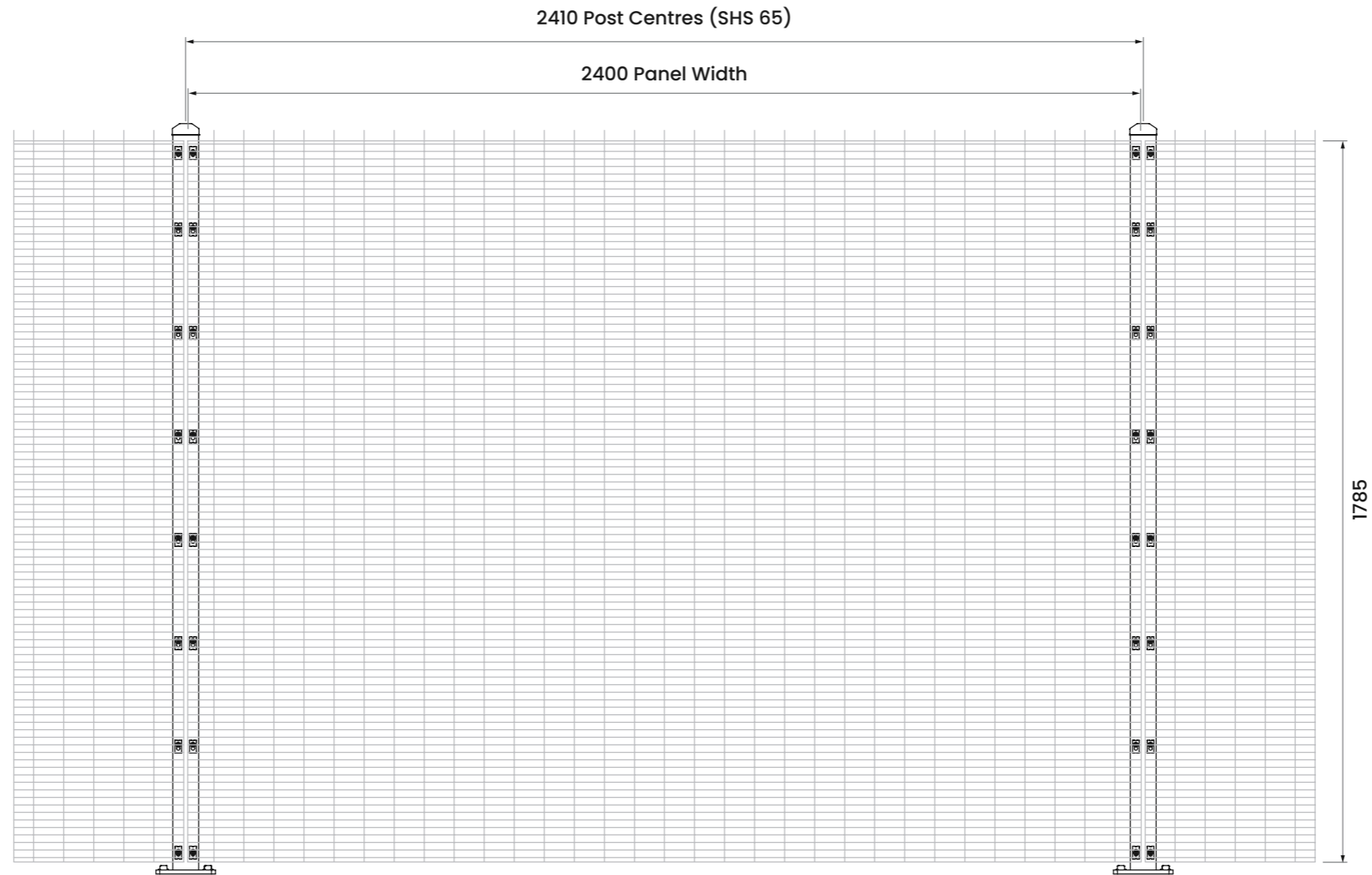

Spec subject to change

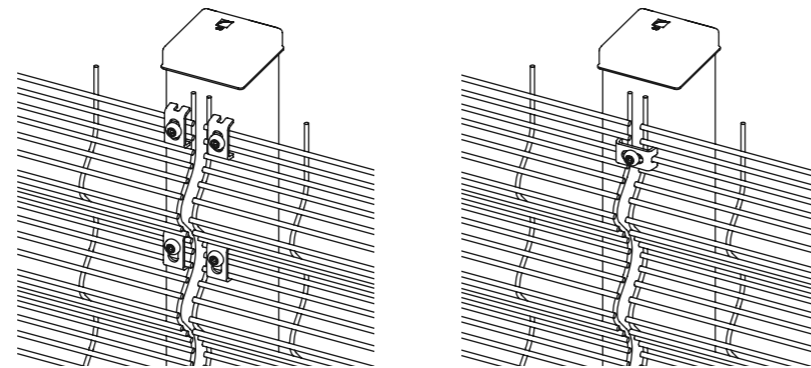

Fixing Detail

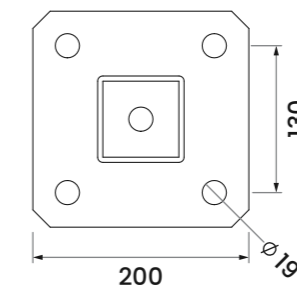
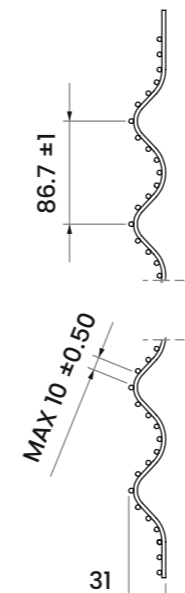

Flange Post

Post Size: 65mm
Flange Thickness: 10mm

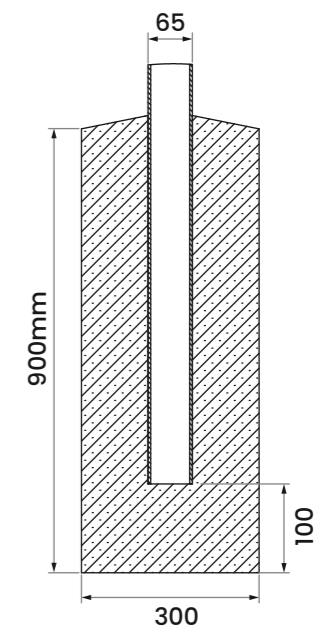

Inground Post

