



H-CLAD

VERTICAL SHIPLAP WEATHERBOARD SYSTEM

TECHNICAL GUIDE FOR SPECIFIERS AND INSTALLERS

CONTENTS

1.0 Introduction.....	3	8.0 Profile Range.....	5-9
1.1 Profiles			
1.2 Timber Species			
1.3 Accessories		9.0 Accessory Range.....	9
1.3 Compliance			
2.0 Scope and Limitations.....	4	10.0 Installation.....	10-13
2.1 Wind-zones		10.1 Installers	
2.2 Risk Matrix		10.2 Wall Underlay	
2.3 Building height		10.3 Cavity Batten Installation	
2.4 Orientation		10.4 Weatherboard Installation	
2.5 Installation			
3.0 Accessories by others.....	4	11.0 Construction Details.....	14-29
3.1 Flashings			
3.2 Flexible Wall Underlay			
3.3 Rigid Air Barriers			
3.4 Flexible Sill and Jamb Flashing Tapes			
3.5 Fixings			
4.0 Framing Design.....	4-5		
4.1 Framing Layout			
4.2 Cavity Battens			
5.0 Storage and Handling.....	5		
5.1 Storage			
5.2 Handling			
6.0 Maintenance.....	5		
7.0 Coatings.....	5		
7.1 Oils and Stains			
7.2 Paint			

1.0 Introduction

HTL Vertical Weatherboards Cladding System is a drained cavity exterior cladding system designed to meet the requirements of the New Zealand Building Code and intended for use as the primary cladding in residential and light commercial buildings built in accordance with NZS3604-2011

The HTL Vertical cladding system is an alternative solution and has been tested to meet the requirements of E2/VM1.

The cladding system is available in a variety of timber species and in a number of popular profiles with either smooth or band-sawn finish.

It can be installed over both flexible wrap or rigid air barrier systems.

1.1 Profiles

The following profiles manufactured by HTL are covered in this guide and will meet the requirements of the New Zealand Building Code.

- HTL51, HTL52, HTL53, HTL54, HTL55, HTL56, HTL58 and HTL59, HTLVS1, HTLVS2, HTLVS3, HTLVS4, HTLVS5, HTLVS6, HTLVS7, HTLVS8, HTLVS9, HTLVS10, HTLVS12, HTLVS14 and HTLVS15. All profile are 19mm in thickness except for HTLVS12-28mm, HTLVS14-28mm and HTLVS15-25mm

1.2 Timber Species

HTL Weatherboards are available in the following species all of which meet the requirements of the NZ Building Code for Clauses B1 Structure, B2 Durability and E2 Exterior Moisture when installed in accordance with this installation guide.

Treatment free:

Siberian Larch, New Zealand Larch, Western Red Cedar, New Zealand Macrocarpa and New Zealand Lawsons Cypress.

All Radiata Pine is CCA treated to H3.2. hazard level

1.3 Accessories

A range of accessories are available from HTL which must be used where applicable. Substitution is not advisable as all testing has been carried out with accessories and materials stated in the guide. Timber accessories are all available in the timber species referred to in para 1.2.

Mouldings:

- External corner mouldings; HTL93
- Internal corner moulding; HTL40 and HTL42
- Cover battens; HTL901, HTL902
- Eaves moulding; HTL32 or HTL33

Cavity Battens:

- 45mm x 20mm H3.2 Treated Radiata cavity battens. HTL-BV20.
- 45mm x 20mm H3.2 Treated Radiata Castellated Cavity Battens. HTLBH20.

Flashings

- Inter-story Z Flashing
- Control Joint Z Flashing
- External Corner Flashing
- Internal Corner Flashing
- Cavity closures

1.3 Compliance

When designed, installed and maintained in strict accordance with this guide the HTL Vertical Weatherboard Drained Cavity System complies with the following clauses of the New Zealand Building Code for cladding in residential and light commercial buildings within the scope of NZS 3604.

- Clause B1 - Structure: Meets the requirements for loads arising from self weight, wind and impact.
- Clause B2 - Durability: Meets requirements for Performance B2 3.1 (b), 15 years and B2.3.2.
- Clause E2 - External Moisture: Performance E.3.2

The HTL Vertical Weatherboard Drained Cavity System is an "Alternative Solution" and has been tested in an appropriately certified test facility and has shown to meet the requirements of E2/VM1 using the details and materials prescribed in this publication.

This product is not subject to a warning or ban under Section 26 of the Building Act 2004.

2.0 Scope and Limitations

The HTL Vertical Weatherboard Cavity System is intended for use as the primary external cladding for buildings for residential and light commercial buildings within the scope of the following.

2.1 Wind zones

The system is suitable for use in wind-zones up to “Very High” when installed with flexible wall underlay and up to “Extra High” when installed in conjunction with an approved proprietary rigid air barrier using the wind zones in accordance with NZS 3604-2011.

2.2 Risk Matrix.

When installed in strict accordance with this installation guide provided the system is suitable for use for walls with a risk score of 0-20 when calculated using the Risk Matrix from Clause E/AS1 Table 2

2.3 Building Height

The system is intended for buildings within the scope of NZS 3604. Building must not exceed 10 metres unless a specific design is provided by a suitably qualified professional.

2.4 Orientation

The vertical weatherboards must be installed vertically over horizontal castellated battens and vertical solid battens as detailed and must be installed on flat surfaces.

2.5 Installation

The cladding system and all componentry supplied by HTL Group or otherwise must be installed by an experienced cladding installer and a current Licensed Building Practitioner.

3.0 Accessories by other

3.1 Flashings

Flashings must be installed as shown in the details contained in this guide.

Flashings must meet the requirements for sizes, laps, folds and as prescribed in E2/AS1 Para 4,5 and 6.

Flashings should be metal flashings with materials in contact and environments (such as sea spray zones) taken into account.

Refer to NZS 3604, Section 4 and E2/AS1, Table 20.

Note: Flashings in contact with CCA treated components are required to be stainless steel. Consult E2/AS1 Tables 21 and 22 for guidance.

HTL recommend Quick Flash flashings.

3.2 Flexible Wall Underlay

A proprietary breather type building wall underlay complying with E2/AS1 Table 23 are suitable for walls up to and including “Very High” wind zones.

3.3 Rigid Air Barriers

Proprietary plywood, fibre cement or plasterboard rigid air barrier systems complying with E2/AS1 Table 23 must be used in extra high wind-zones. Rigid air barrier may also be used in all other zones.

Where a proprietary system is used, the manufacturer’s specific fixing and installation instructions must be followed.

Where a specific design zone exists a suitably qualified professional must be consulted.

3.4 Flexible Sill and Jamb Flashing Tapes

Flexible flashing tapes must comply with E2/AS1 4.3.11. Manufacturer’s specific installation instructions must be followed and “in contact” compatibility with other materials and sealants should be considered.

3.5 Fixings

Weatherboard fixing nails should be minimum 75 x 3.15
Fixings fixing durability should comply with Clause E2/AS1 materials compatibility

4.0 Framing Design

Framing must meet the requirements of Clause B1 and B2 of the New Zealand Building Code and comply with the requirements and limitations of NZS 3604:2011.

Buildings and walls outside the scope of NZS 3604 are deemed to be specific design. Specific designs must be carried out by a suitably qualified professional.

Framing must be machine gauged structural grade in accordance with NZS 3604:2011 treated to a minimum of H1.2.

4.1 Framing layout

Studs placed at a maximum of 600mm centres
Horizontal nogs/dwangs are placed at a maximum of 480mm centres.
Studs and nogs must be fixed in accordance NZS 3604:2011.

4.2 Cavity Battens

Vertical timber cavity battens are nominal 45mm x 20 mm merch grade radiata pine treated to minimum H3.1.
Vertical battens are placed as detailed in this guide, generally at corners and each side of openings fastened to studs.

Horizontal battens are HTLBH20 Castellated battens nominal 45mm x 20mm radiata pine treated minimum H3.1.
Horizontal battens are placed on all horizontal nogs/dwangs, on bottom and top of wall framing and top and bottom of openings.

All cavity battens must be installed over solid timber with minimum 50mm x 2.8mm jolt or flat head nails minimum hot dip galv. Where installation is in sea spray zone fastenings must be stainless.

5.0 Storage and Handling

5.1 Storage

Ensure Weatherboards are kept dry until installed.
Weatherboards must be stored indoors with a 100mm clearance to ground. Including to concrete. The stack should be supported by blocking at 1.00 metre centres. Where the stack is covered it must be covered four sides. Do not leave the underside exposed to Moisture

5.2 Handling

Weatherboards are a finished product and should be treated as such with care. Particular care should be taken with board edges to avoid damage.
Avoid dragging boards over each other.

6.0 Maintenance

In order to meet the requirements of the New Zealand Building Code the property owner has a responsibility to maintain the cladding to ensure longevity and weather tightness.

Exterior cladding should be thoroughly washed at least once a year using a soft brush and mild detergent. Strong chemical cleaners should be avoided

Any damage to the cladding should be attended to promptly to avoid any further deterioration.

Coatings should be inspected on a regularly and re-coated where necessary.

A planned re-coating schedule should be put in place and carried out at regular intervals depending on the coating type.

Oils and oil stains will generally require re-coating every 2 - 4 years.

Paint coatings will require re-coating every 7- 10 years.

The longevity of paint coatings will depend on film thickness applied and the colour of the coating.

7.0 Coatings

It is not recommended that HTL weatherboards be left uncoated.

7.1 Oils and Stain.

Only DRYDEN WoodOil may be applied to HTL NZLarch Vertical Weatherboards. DRYDEN WoodOil is a water repellent, non-film-ing, deeply penetrating timber protector.

The initial coat is to be applied to all 4 sides, including sealing of all end cuts. The second coat is applied following installation. Dressed Face boards are to be face sanded prior to oiling.

Installers must refer to the DRYDEN WoodOil Data Sheet at "www.dryden.co.nz/media/1407/dryden-woodoil-data-sheet_january-2018.pdf"

7.2 Painting

Good quality acrylic paints should be used and applied by brush or in accordance with the paint manufacturer's specific instructions. Band sawn profiles should not be coated using a roller.

Total film thickness should be a minimum of 90 microns and dark coloured paints should be avoided and restricted to greater than 40% LRV.

Paint coatings should consist of an acrylic undercoat to all four sides of the board and a minimum of two acrylic top coats to the face side with a film thickness of 30 microns per coat.
Cut edges should be coated prior to installation.

8.0 Profile Range

The following profile range is available in Radiata Pine, Siberian Larch and New Zealand Larch.

Commonly used profiles are shown in the following pages. Other profiles are available on request.

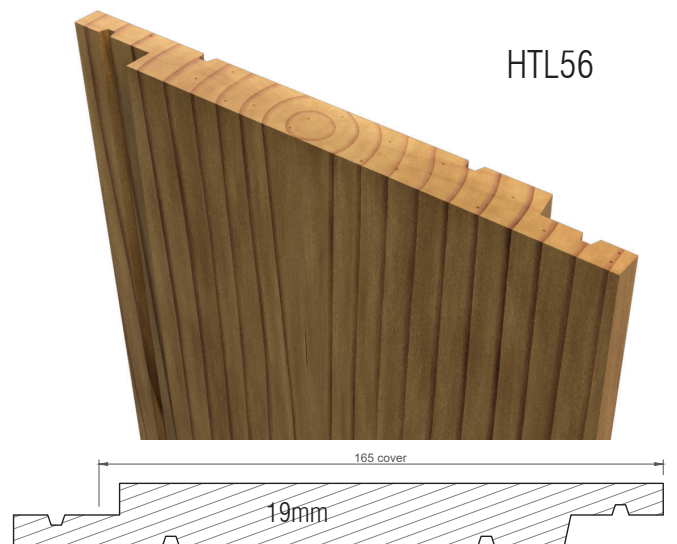
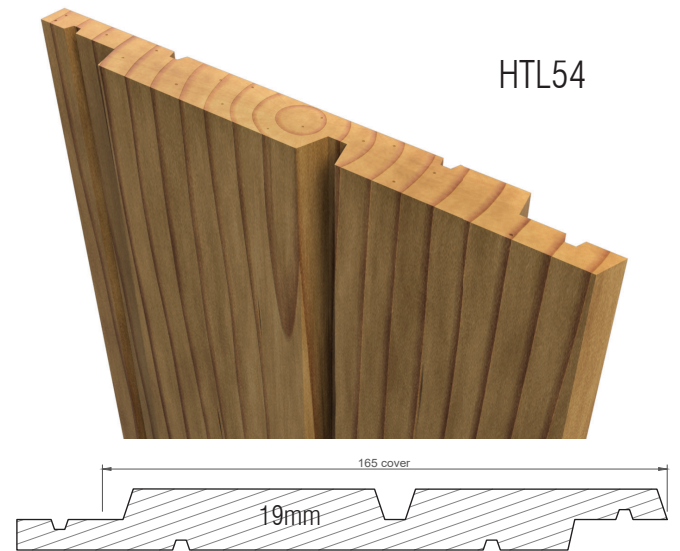
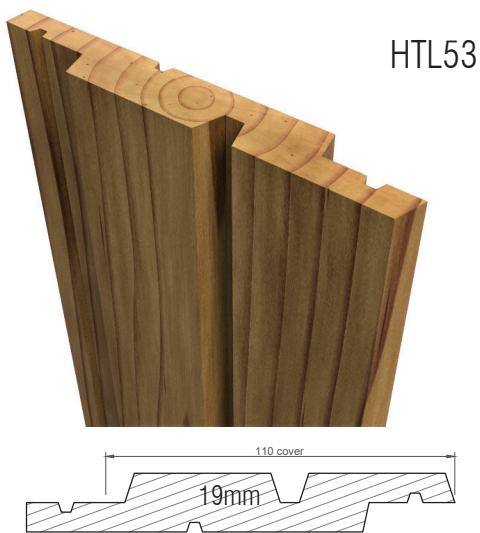
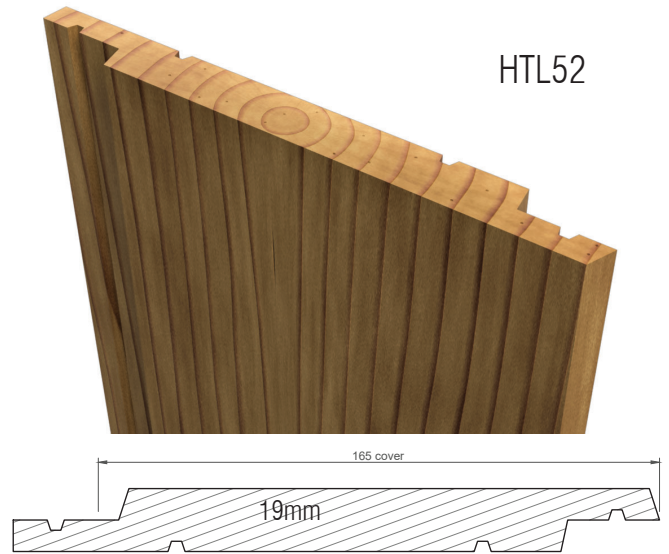
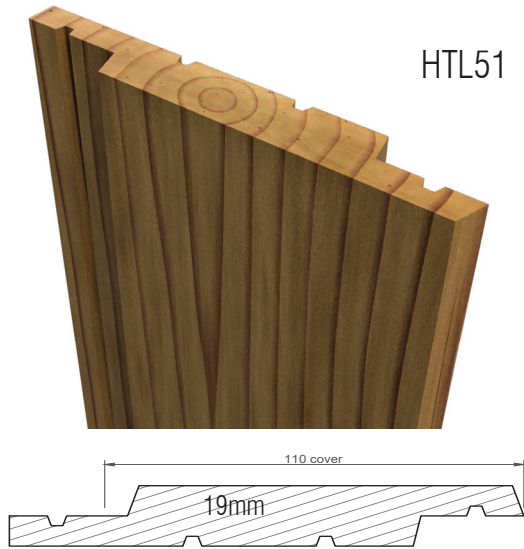

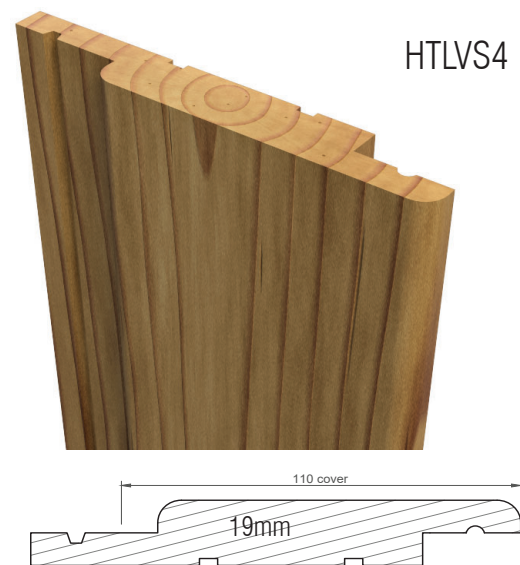
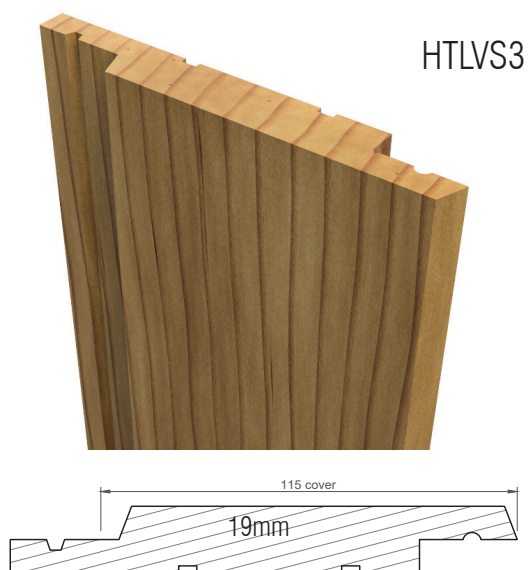
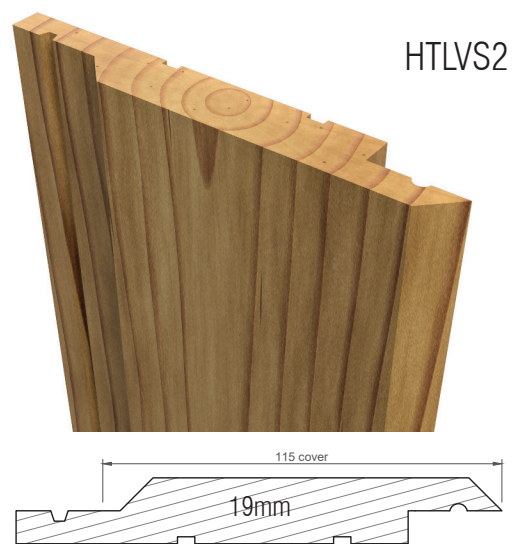
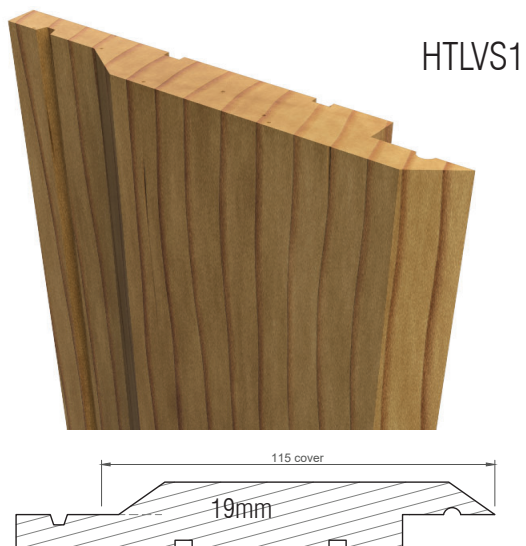
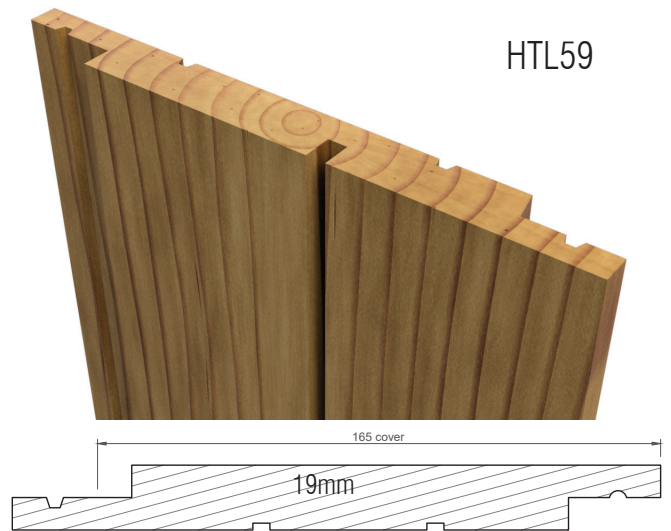
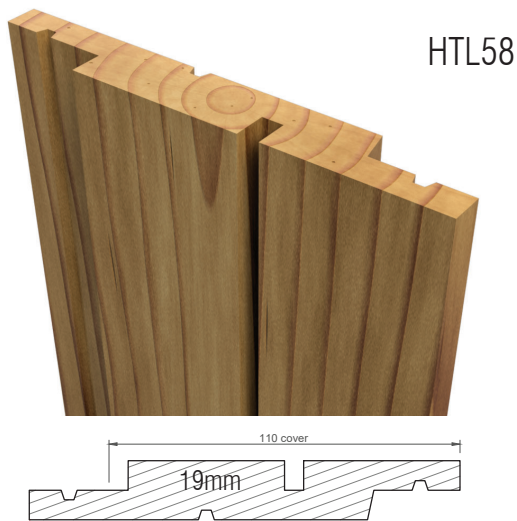

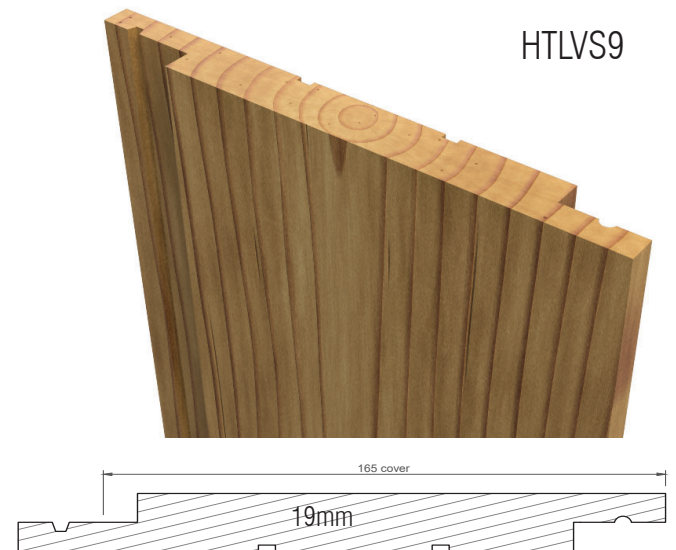
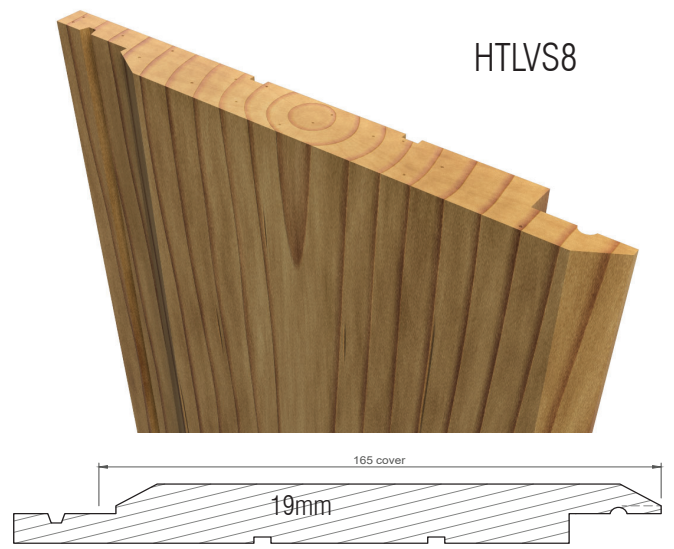
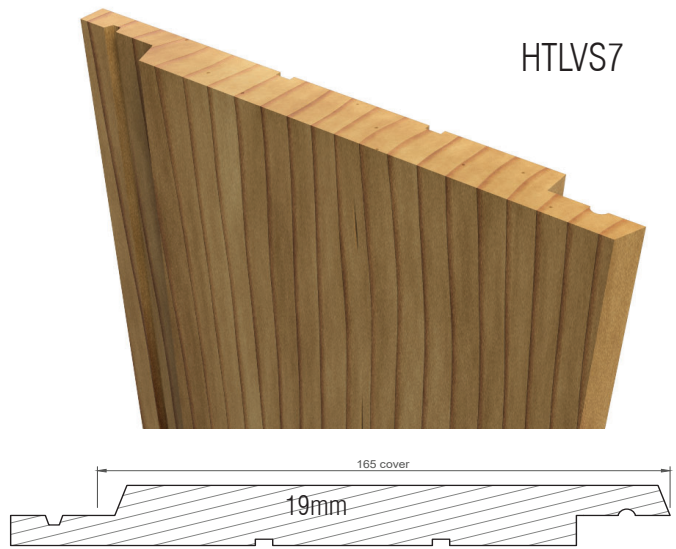
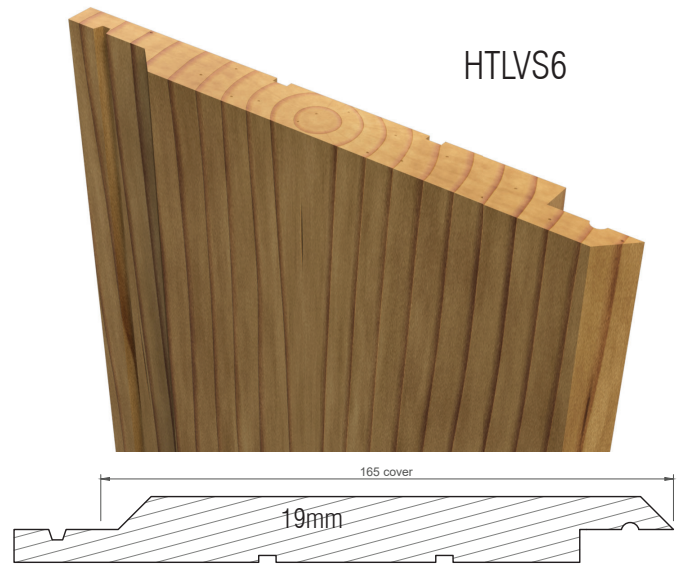
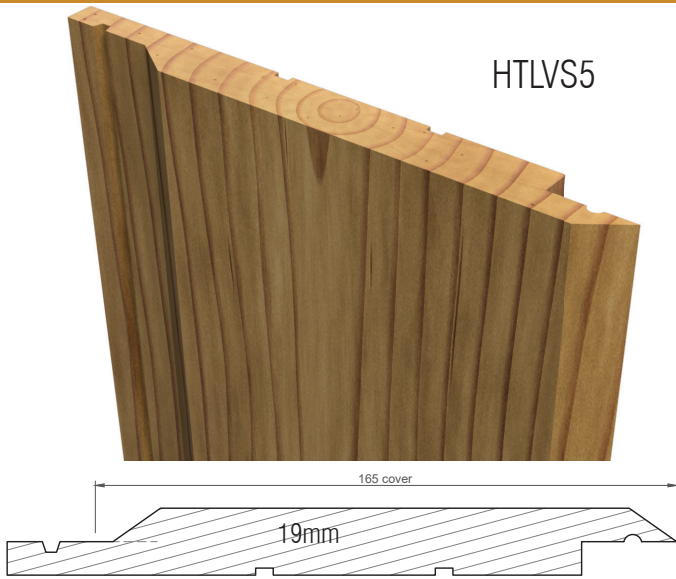

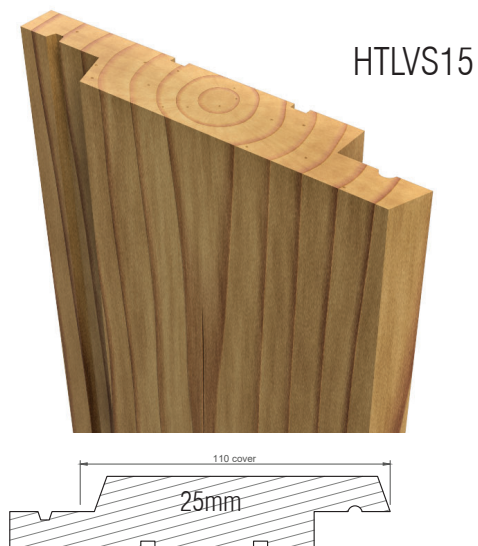
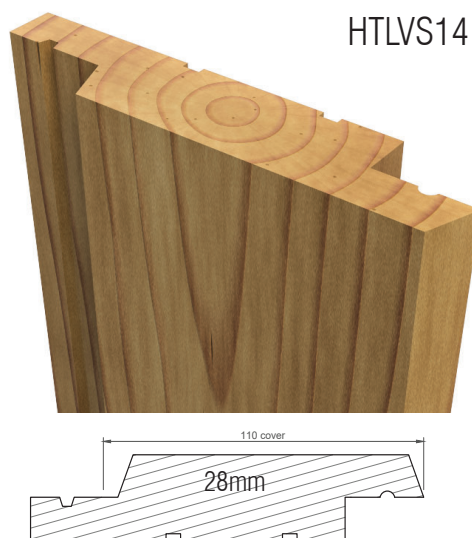
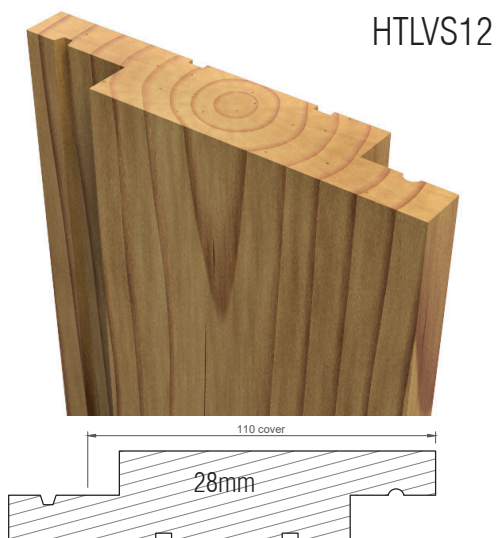

HTL901 Cover Batten



HTL902 Cover Batten

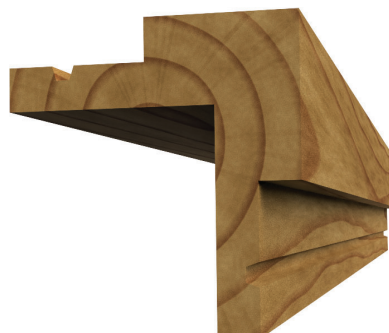

HTL93 External Corner

10.0 Installation

10.1 Installers

Installation must be carried out by a Licensed Building Practitioner, licensed to carry out exterior cladding installations and conversant with the installation of weatherboard systems and drained and ventilated cavity systems.

Care must be taken to install the HTL cladding systems in strict accordance with the details and principles described in this publication.

Good trade practice must be observed at all times.

10.2 Wall Underlay

Flexible building underlay must be a breather type wall underlay complying with E2/AS1 Table 23.

The underlay should be laid as continuously as practical, horizontally across the studs, pulling the underlay tight to avoid wrinkles.

Where vertical joints cannot be avoided, an overlap of a minimum of 150mm must be formed.

Horizontal joints should overlap by a minimum of 75mm.

The wall underlay must be continuous around both internal and external corners and continue around corners by a minimum of 300mm.

Where rigid air barriers are required, either proprietary plywood, fibre cement or plasterboard rigid air barrier systems complying with E2/AS1 Table 23 must be used or as per E2/AS1 9.1.7.2.

Installation of proprietary systems must follow the specific

10.3 Cavity Batten Installation

All horizontal battens must be HTLBH20 nominal 45mm x 20mm H3.2 castellated cavity battens nailed to horizontal nogs/dwangs at 300mm centres with 50mm x 2.8mm flat head or jolt head galvanized nails.

All Vertical cavity battens must be solid nominal 45mm x 20mm H3.2 merch grade radiata pine nailed to studs at 300mm centres with 50mm x 2.8mm flat head or jolt head galvanised nails.

10.4 Weatherboard Installation

Weatherboards should be primed with a good quality acrylic primer or oiled on all four sides prior to installation.

Full consideration should be given to where best to start on

the building to best suit prevailing weather and set out to avoid narrow rips at wall ends and at windows and doors.

The boards should be set out to start at a corner and with the first board plumbed and straightened.

Boards must overhang the floor level by a minimum of 50mm and the bottom of the board to ground level must comply with E2/AS1 Para 9.1.3.5.

Boards must lap by a minimum of 25mm with weather-grooves in alignment placing one board at a time. This will leave a 2mm expansion gap between boards.

Pre-drill for nails on a slight slop upward with a drill size slightly smaller than the nail being used.

Battens are not structural. Nails should penetrate the structural framing (the nogs/dwangs or studs) by a minimum of 30mm. Fixing nails should be placed 35mm from the lap edge so that nails do not penetrate both the overlap and underlap.

Where boards are oil coated, silicone bronze or stainless “rose head” nails should be used and driven flush to the board surface.

Where boards are painted, galvanized or stainless “jolt head” nails should be used and driven flush with the surface of the board and then punched below the surface for filling prior to painting.

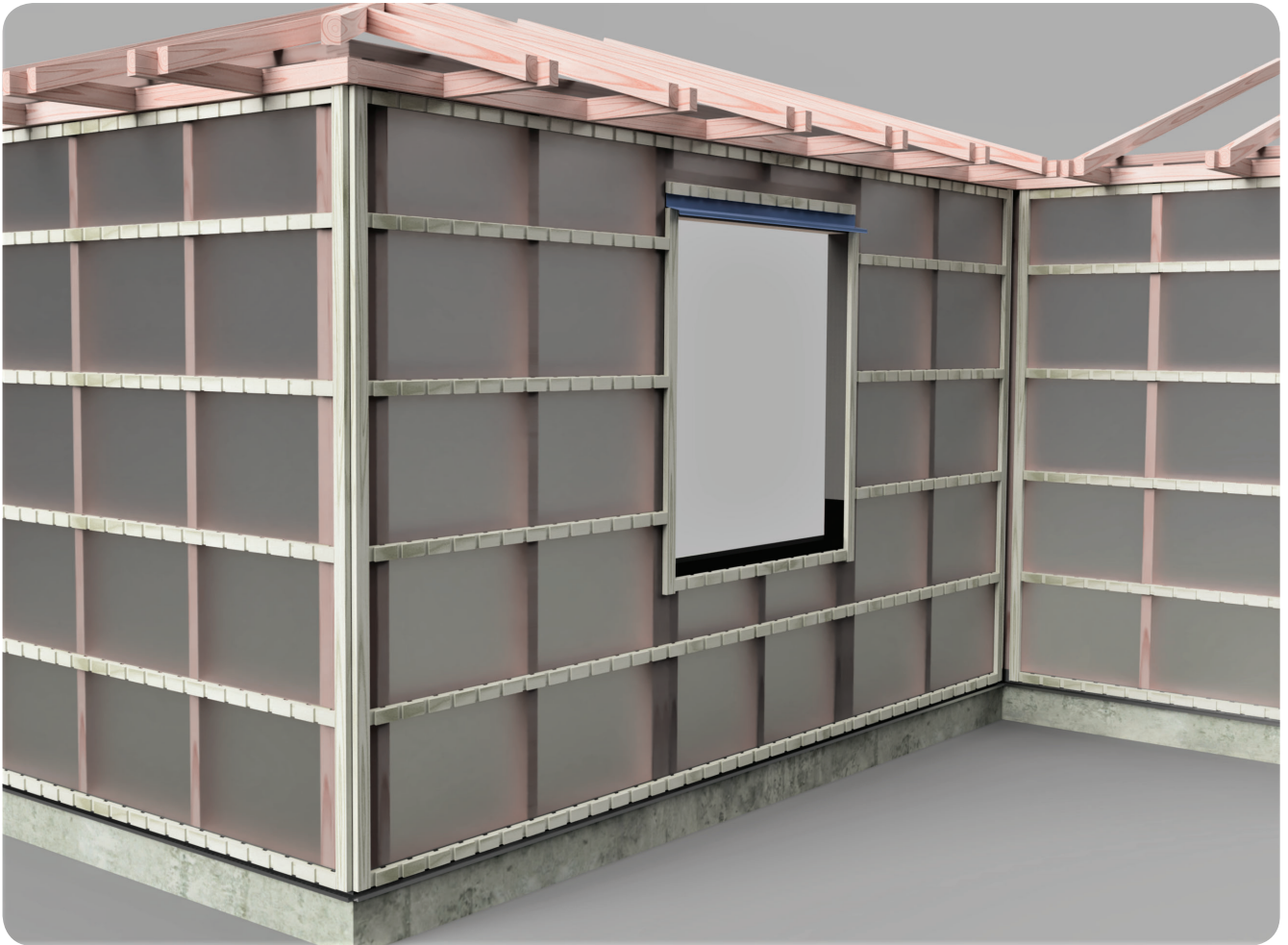

Typical Batten layout

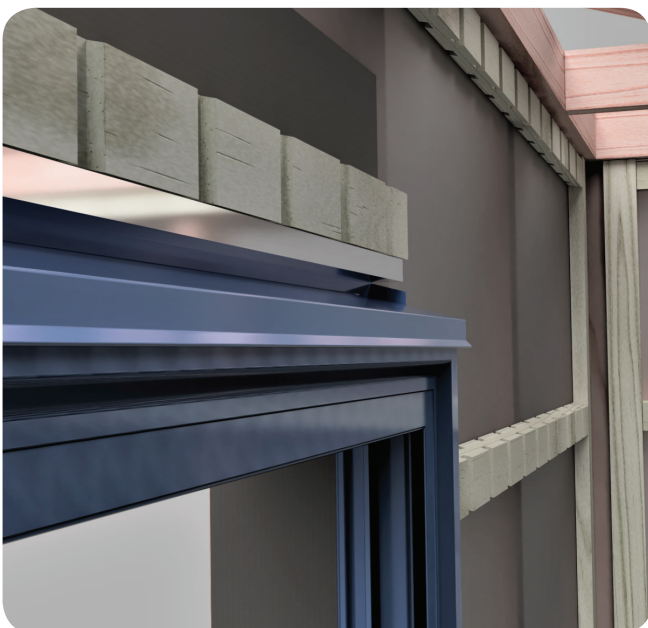

Typical Window Head and Sill Batten layout

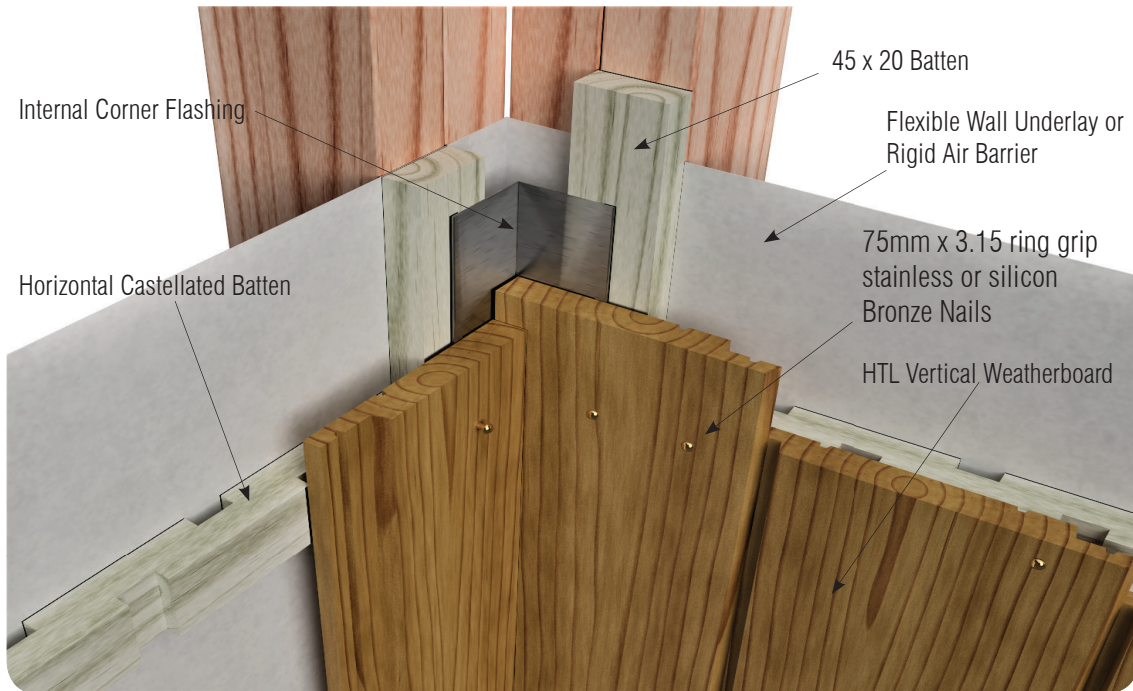

Typical Internal Corner Detail

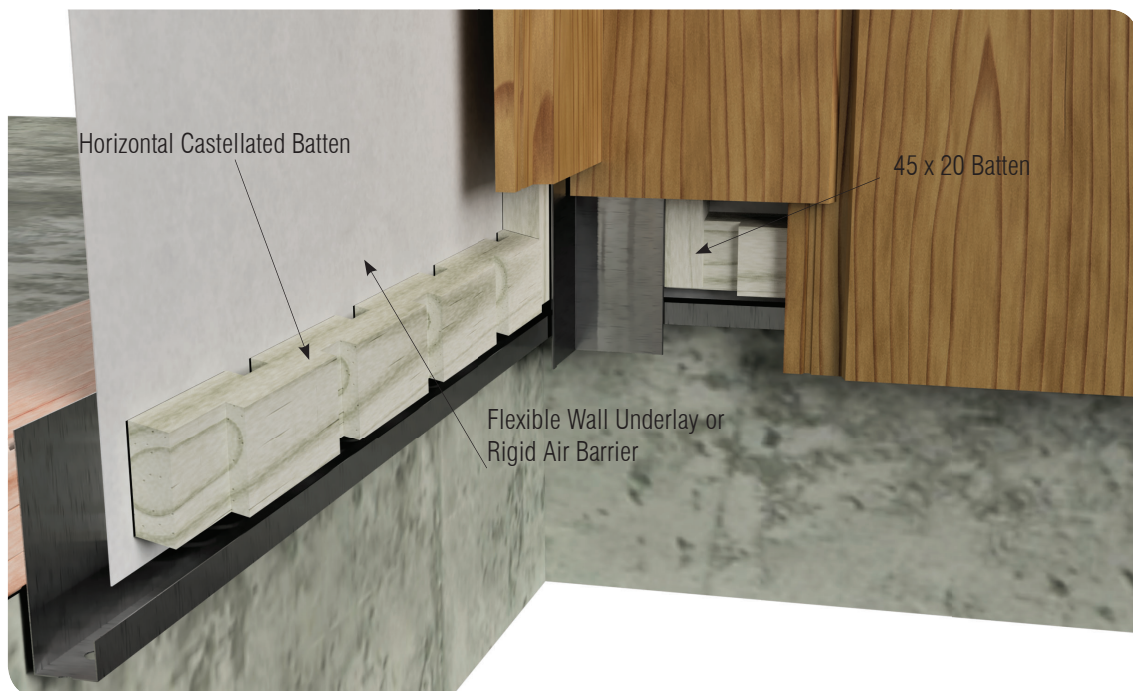

Typical Floor Junction Detail

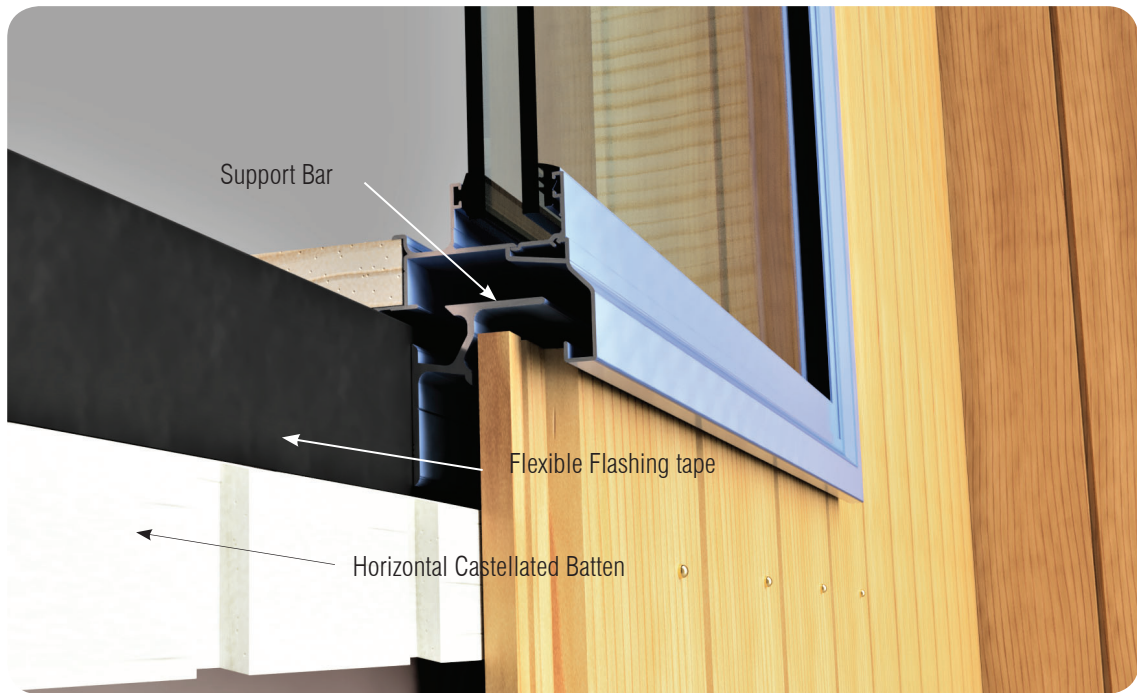

Typical Sill Detail



Typical Window and door Detail

Typical Wall Layout

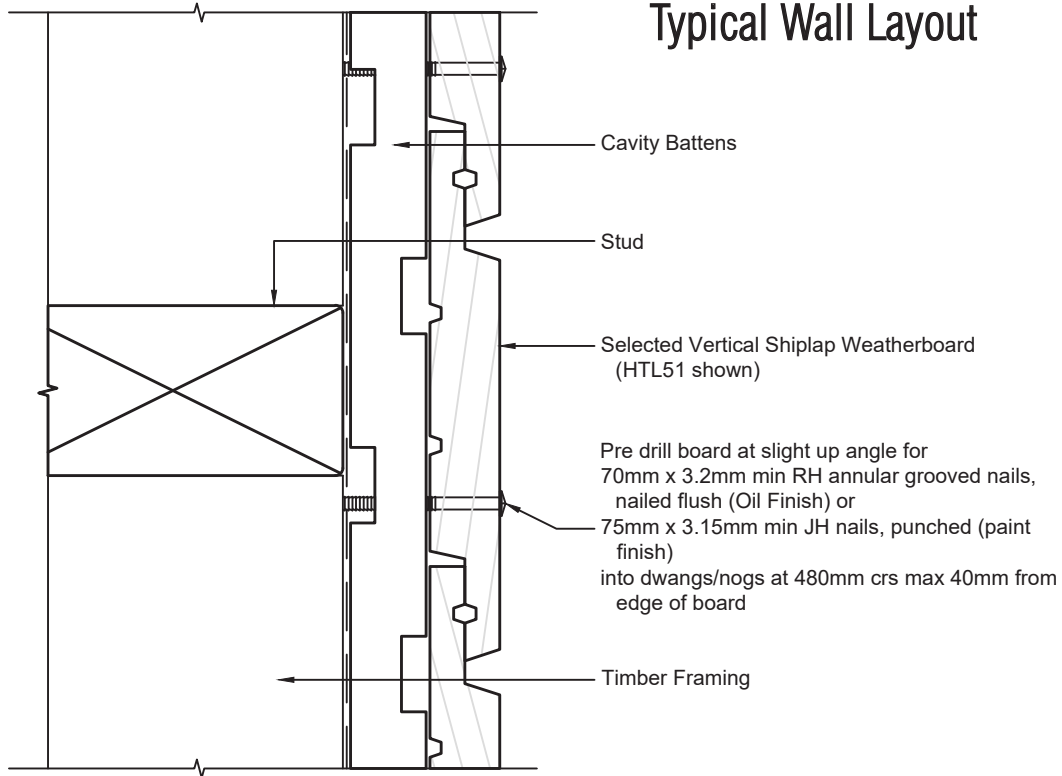

Horizontal cross section

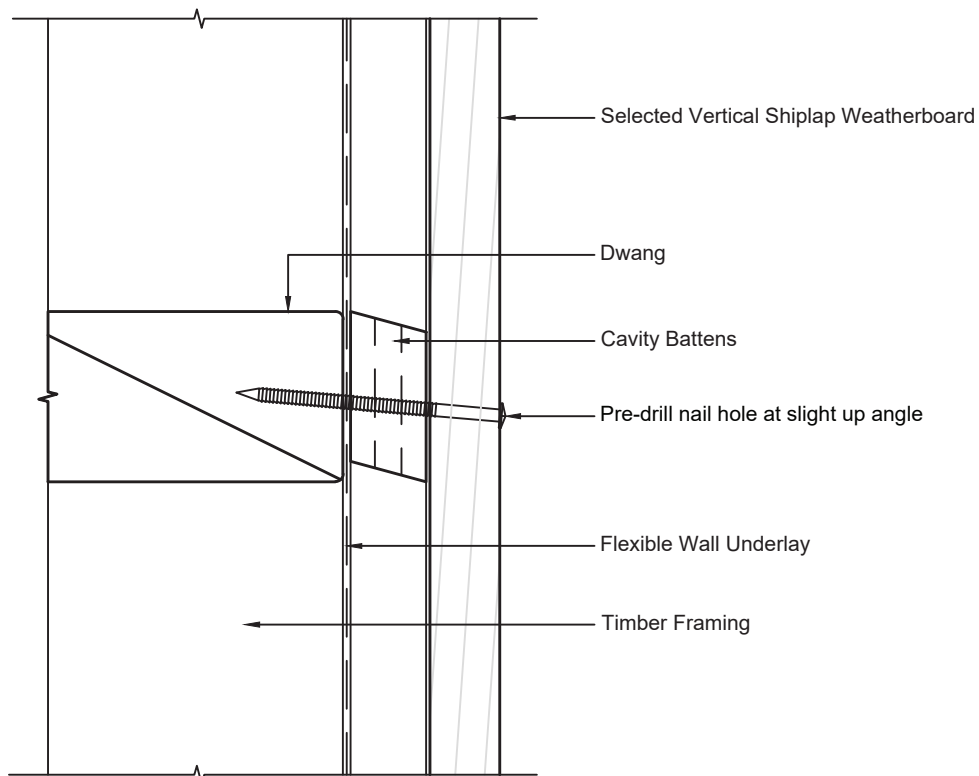

Vertical cross section

Typical Bottom Plate Timber Floor

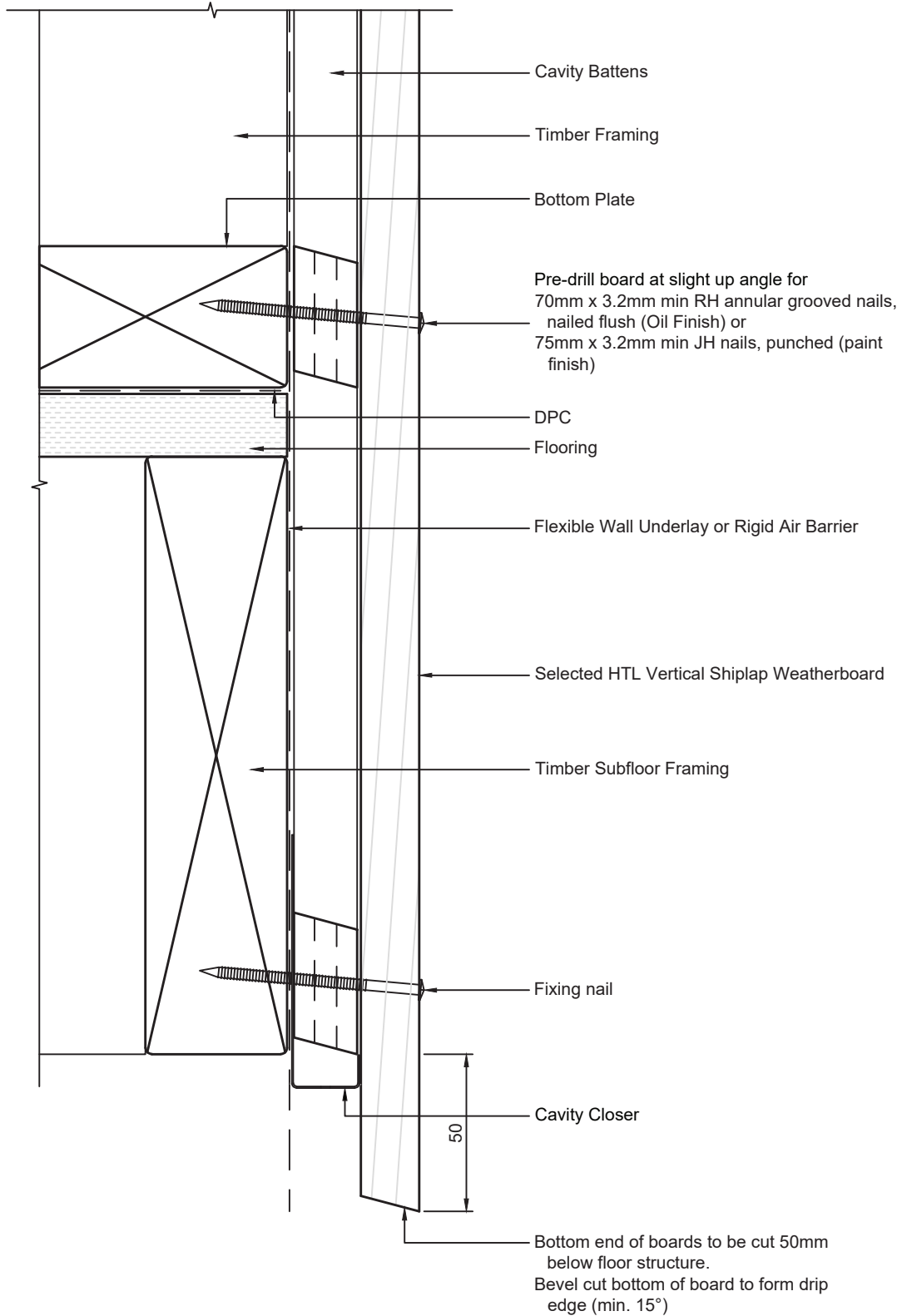

Typical Bottom Plate Concrete Floor

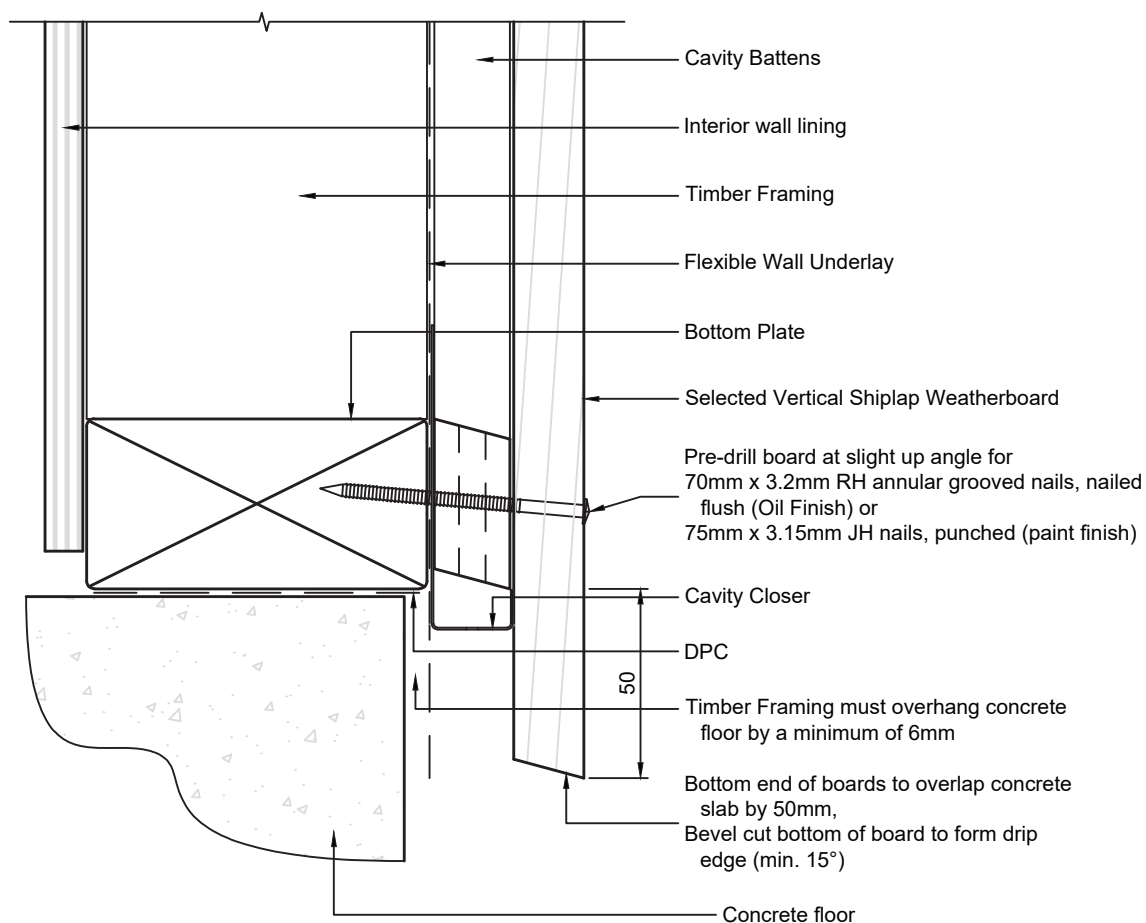

Typical Corner Detail Option A

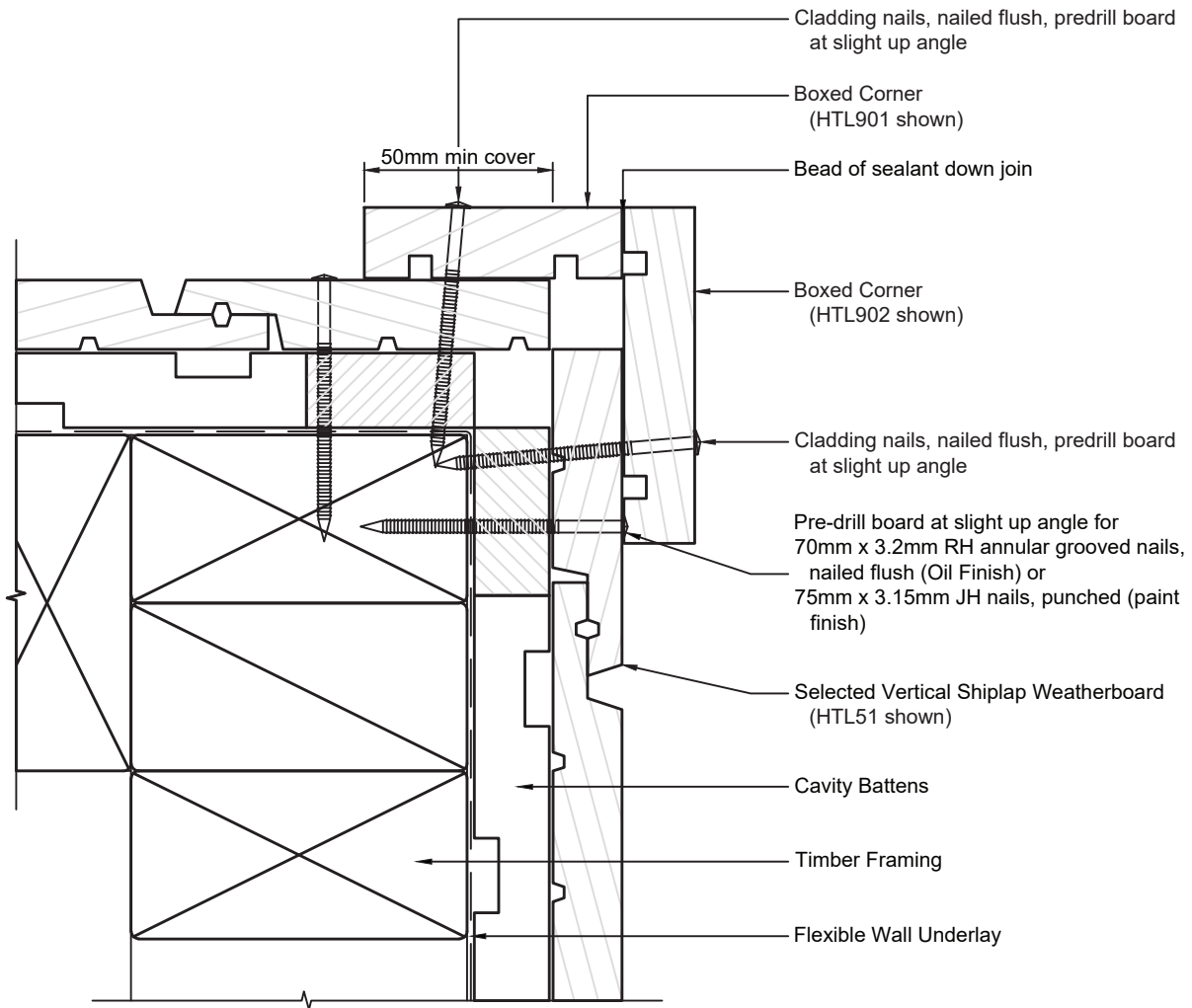

Option A

Typical External Corner Detail Option B

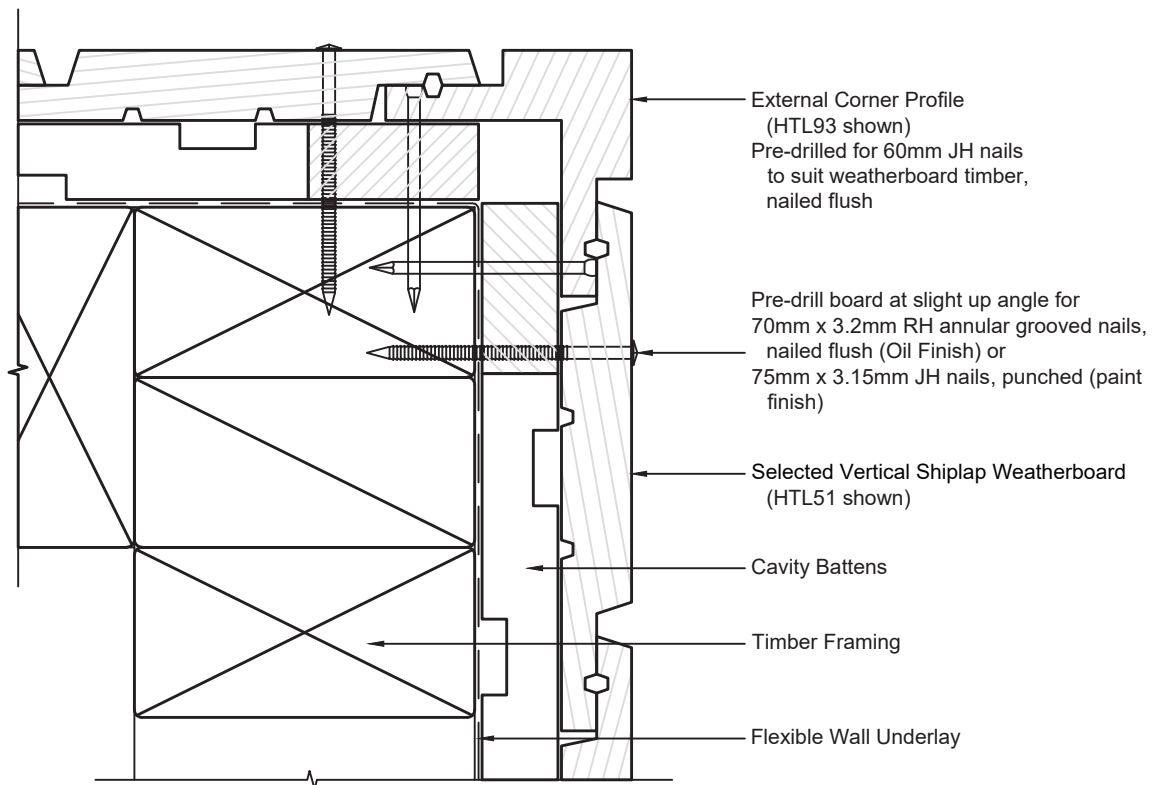

Option B

Typical Internal Corner Detail

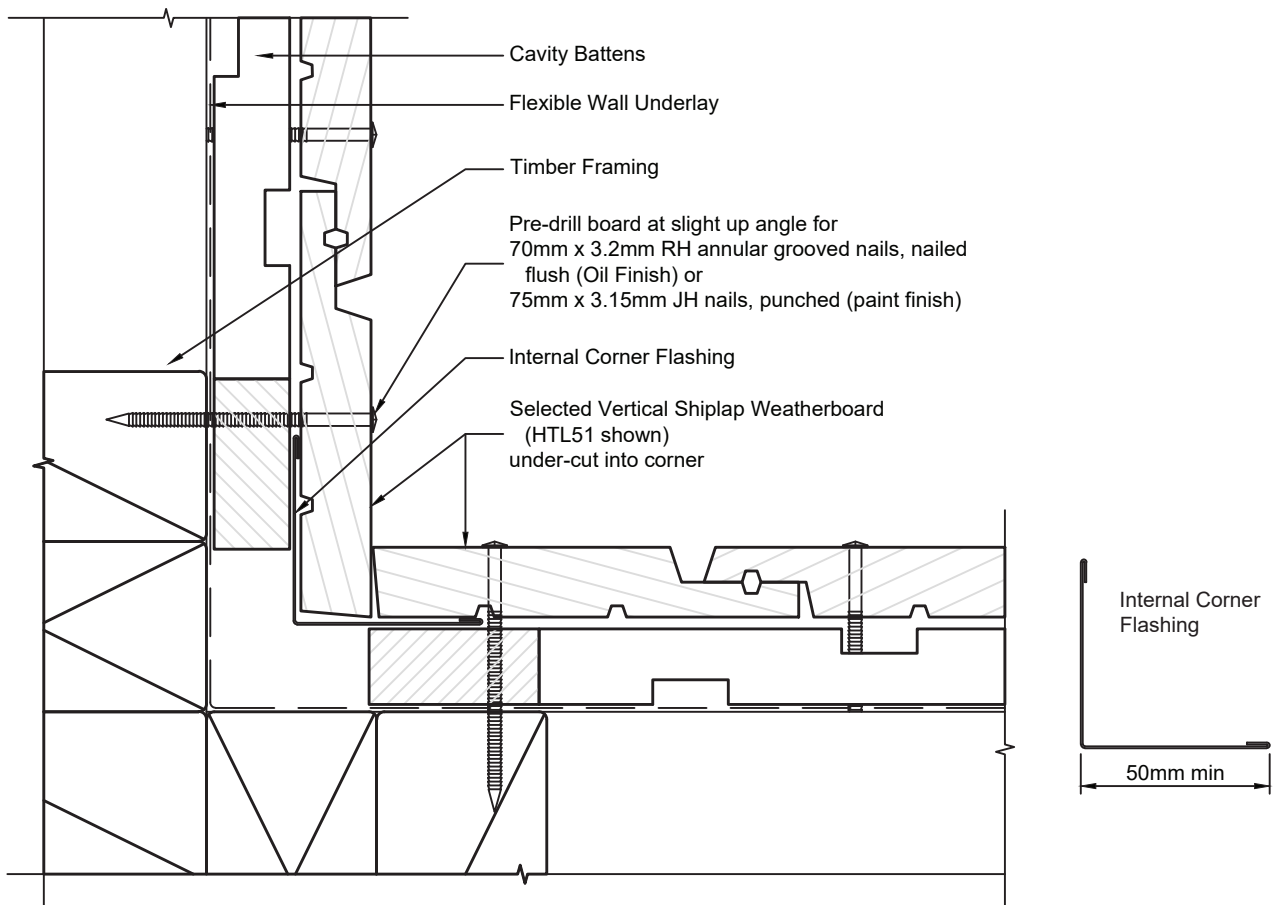

Typical Window Head and Sill Details

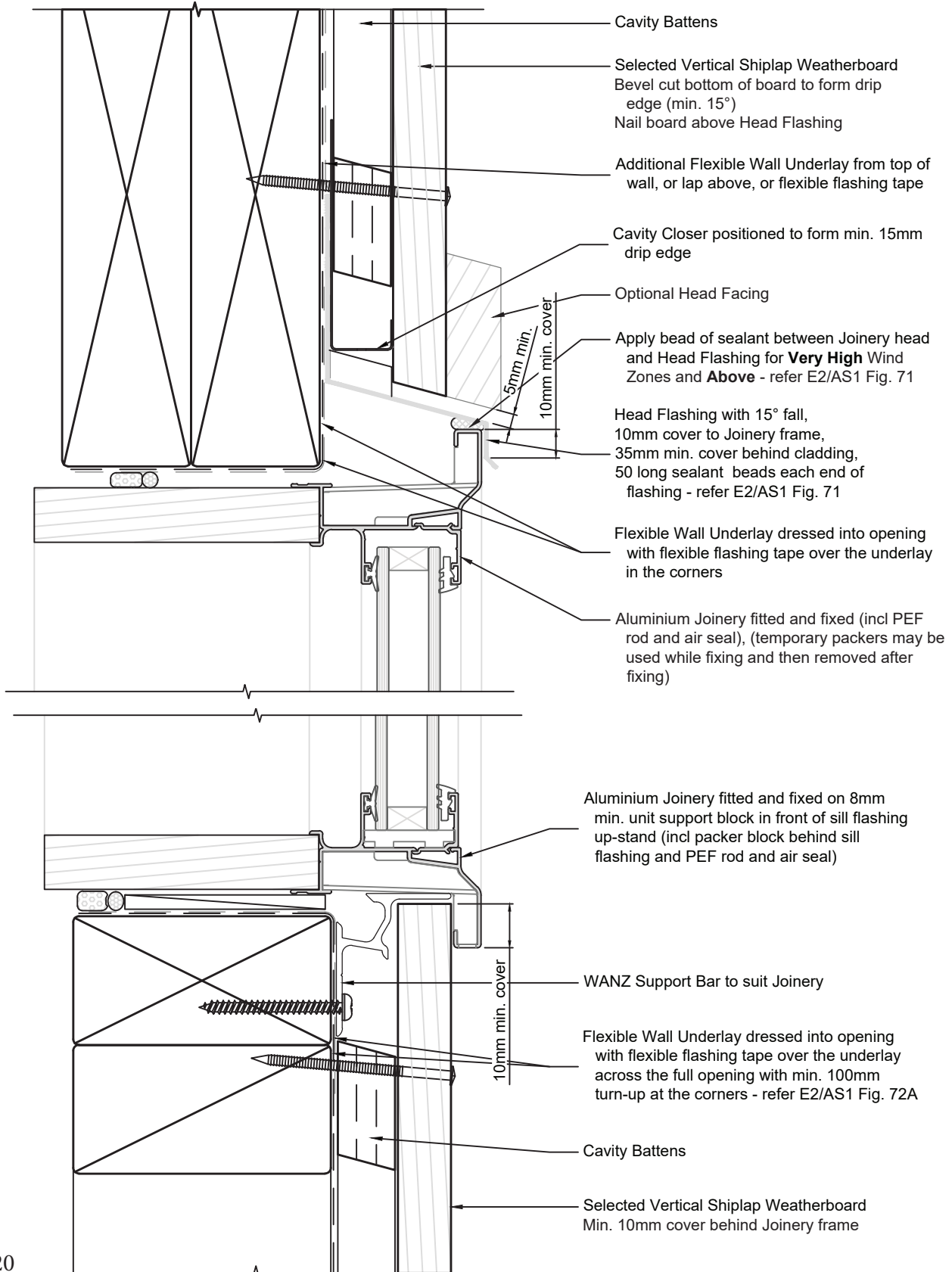

Typical Window Jamb Detail

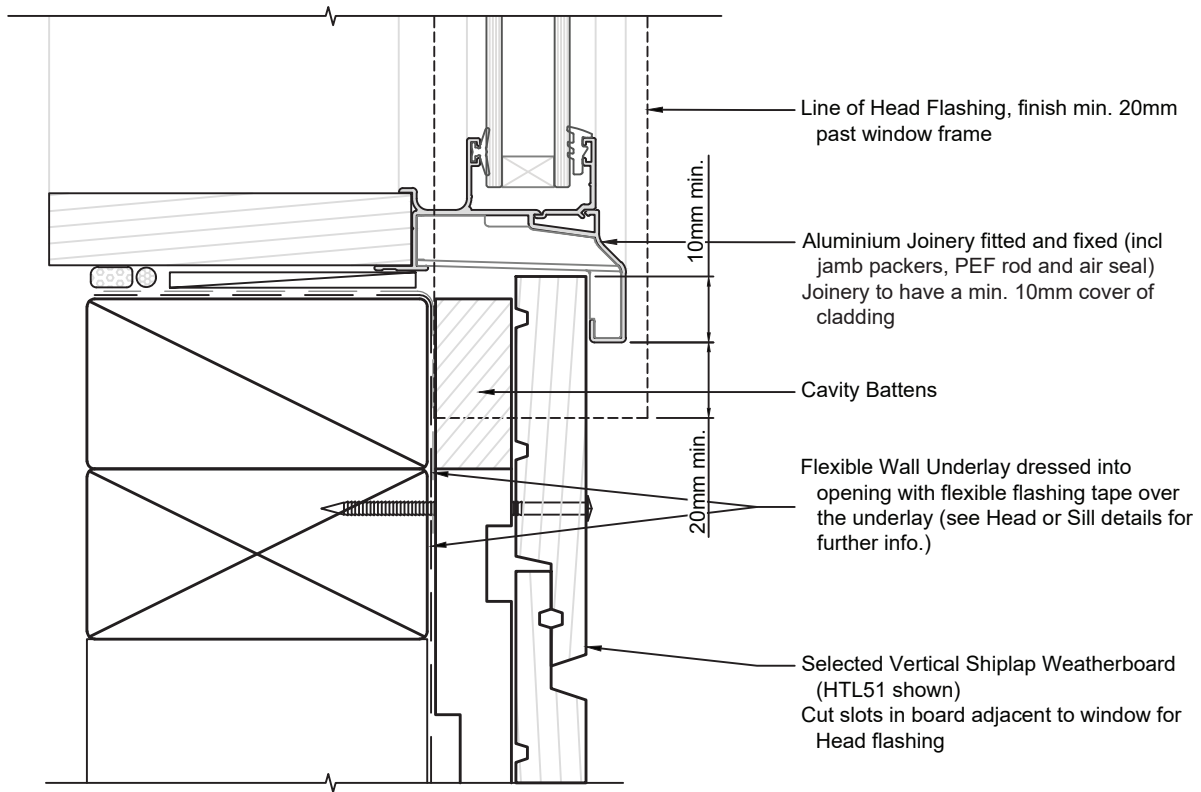

Typical Soffit Detail

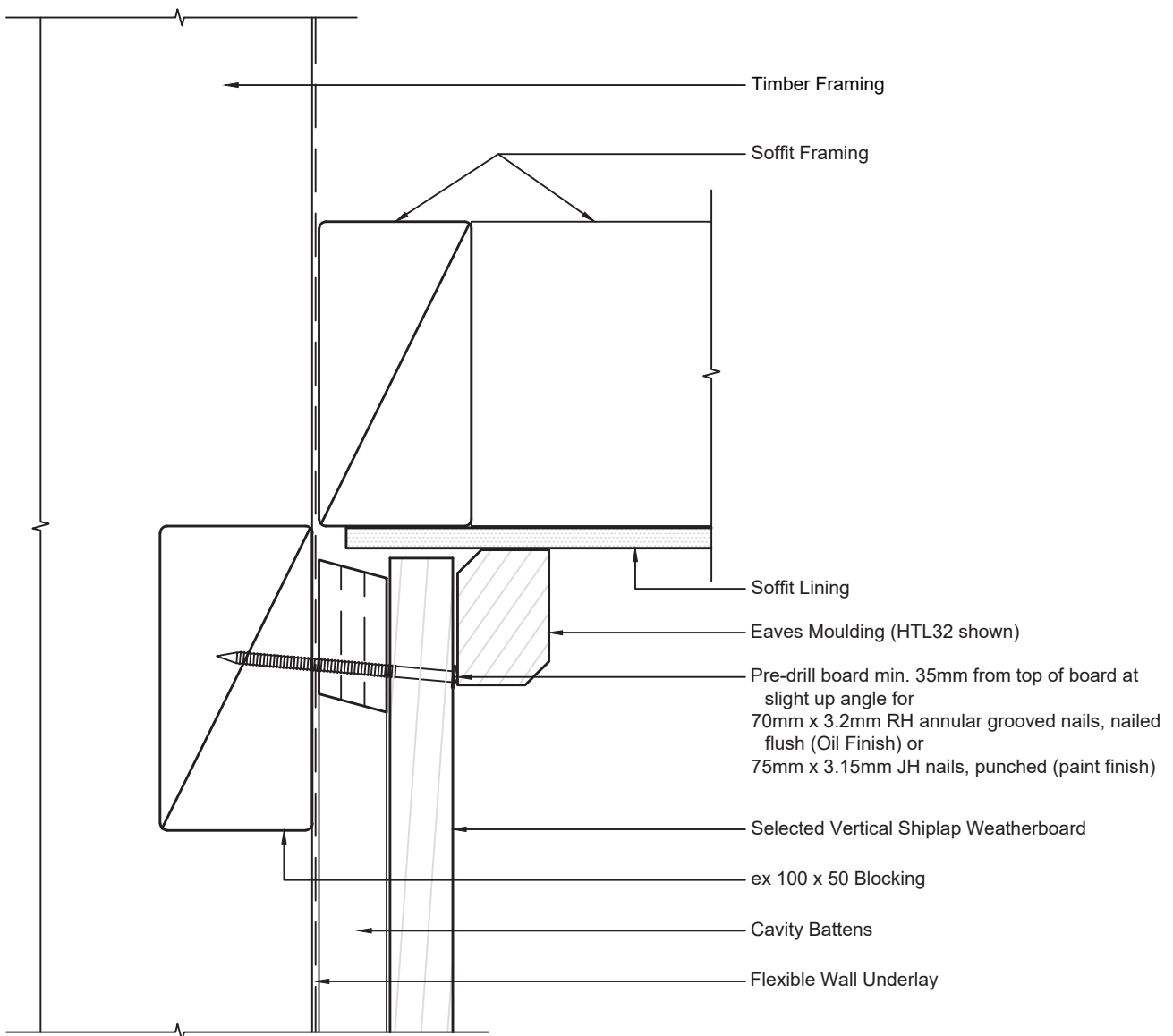

Typical Fascia Detail

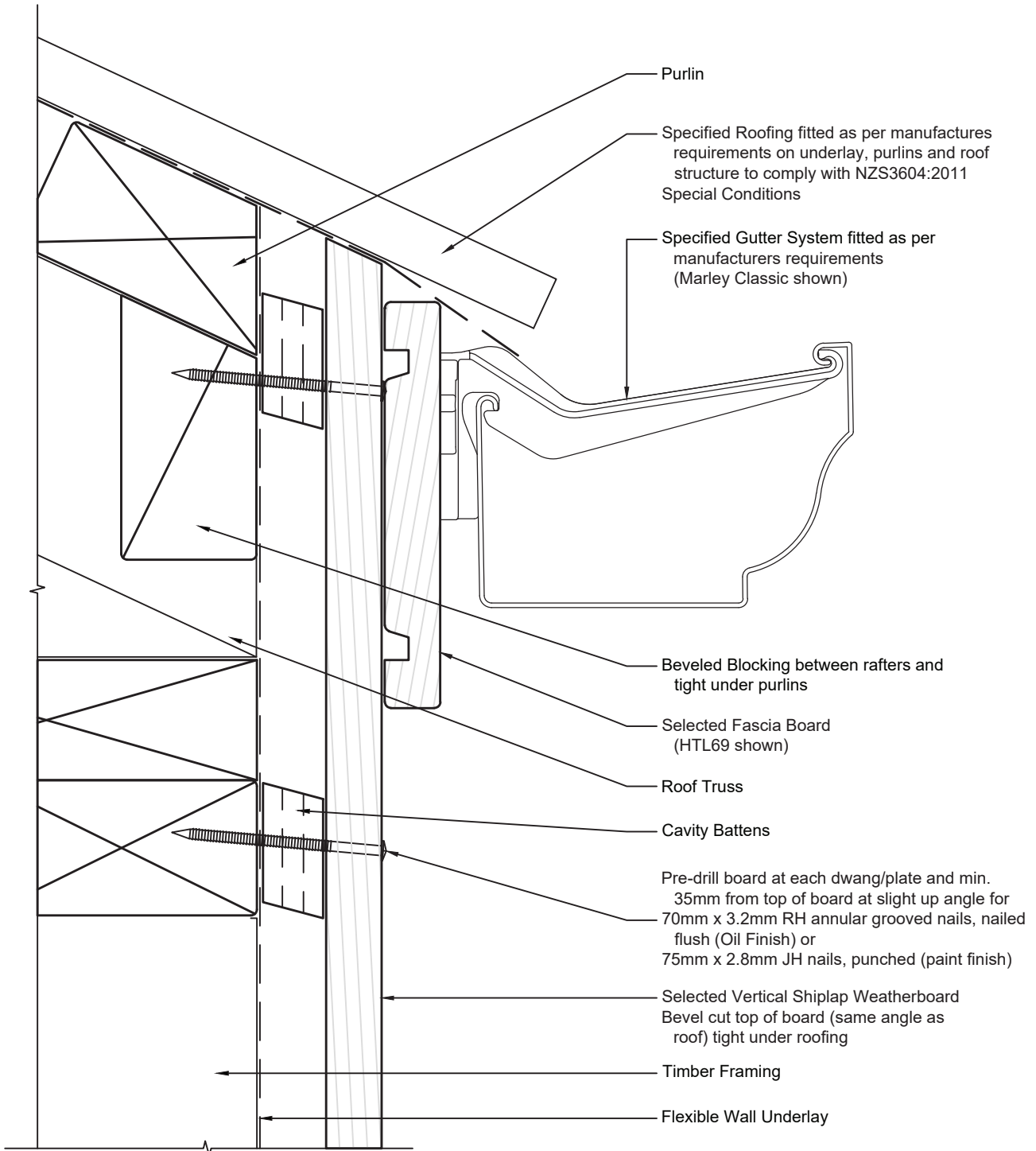

Typical Roof Detail

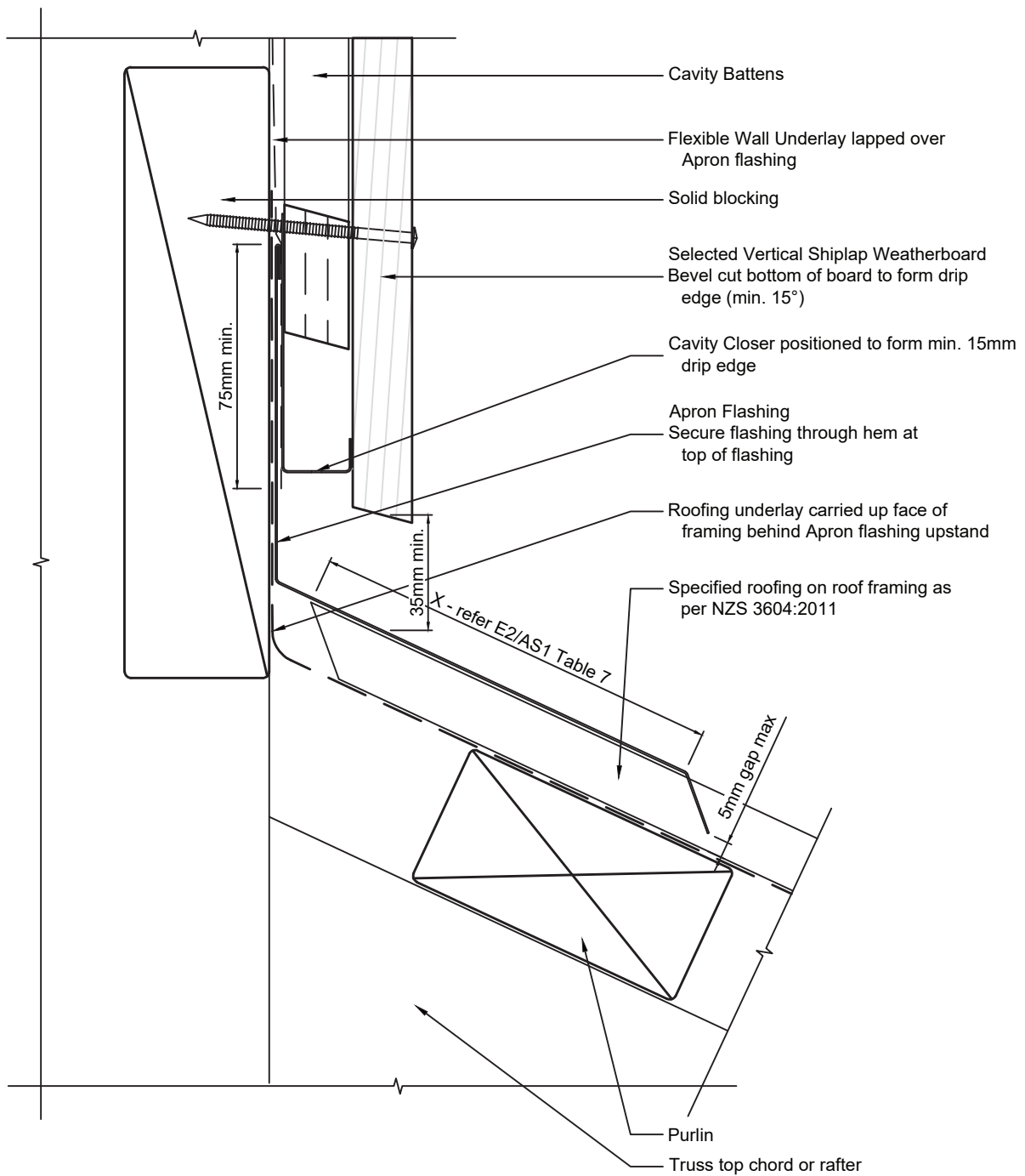

Typical Drained Inter-Story Joint Detail

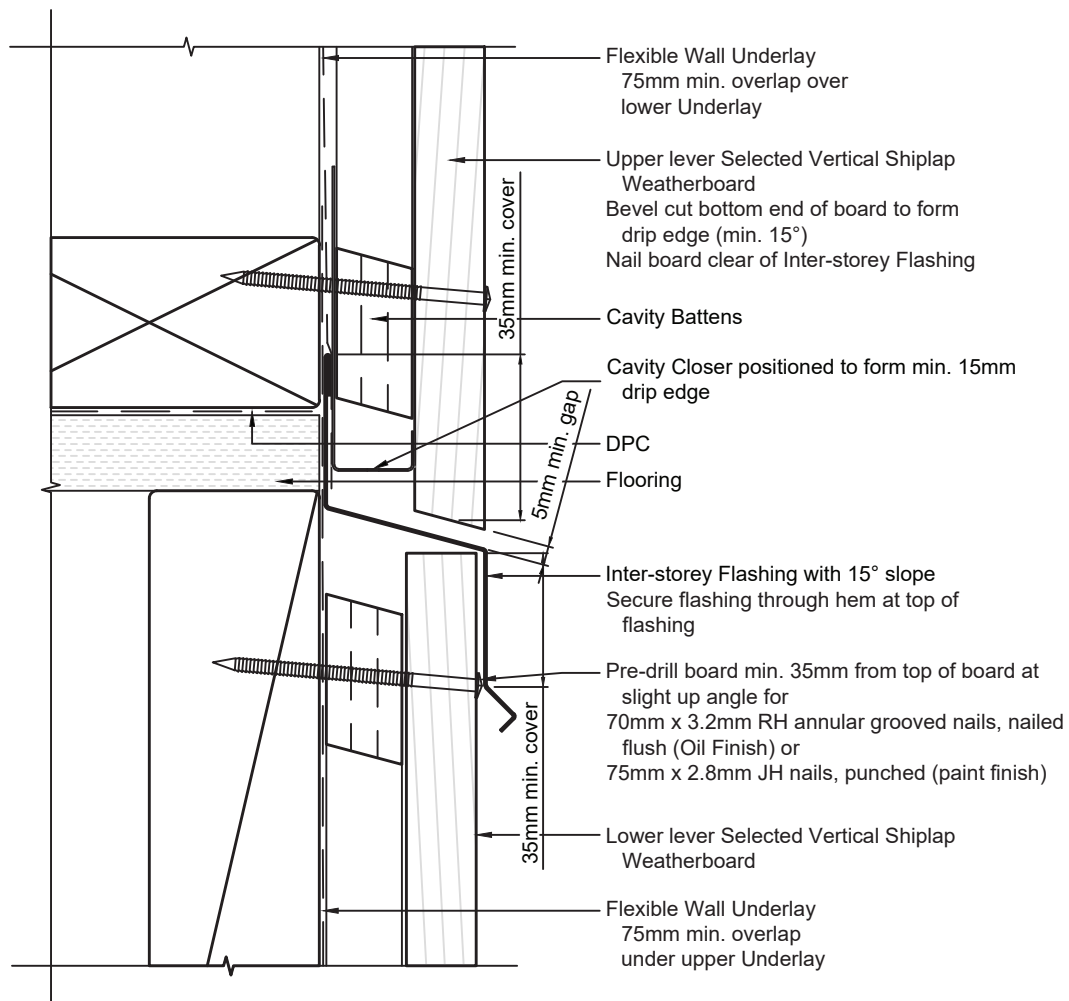

Typical Horizontal Joint Detail

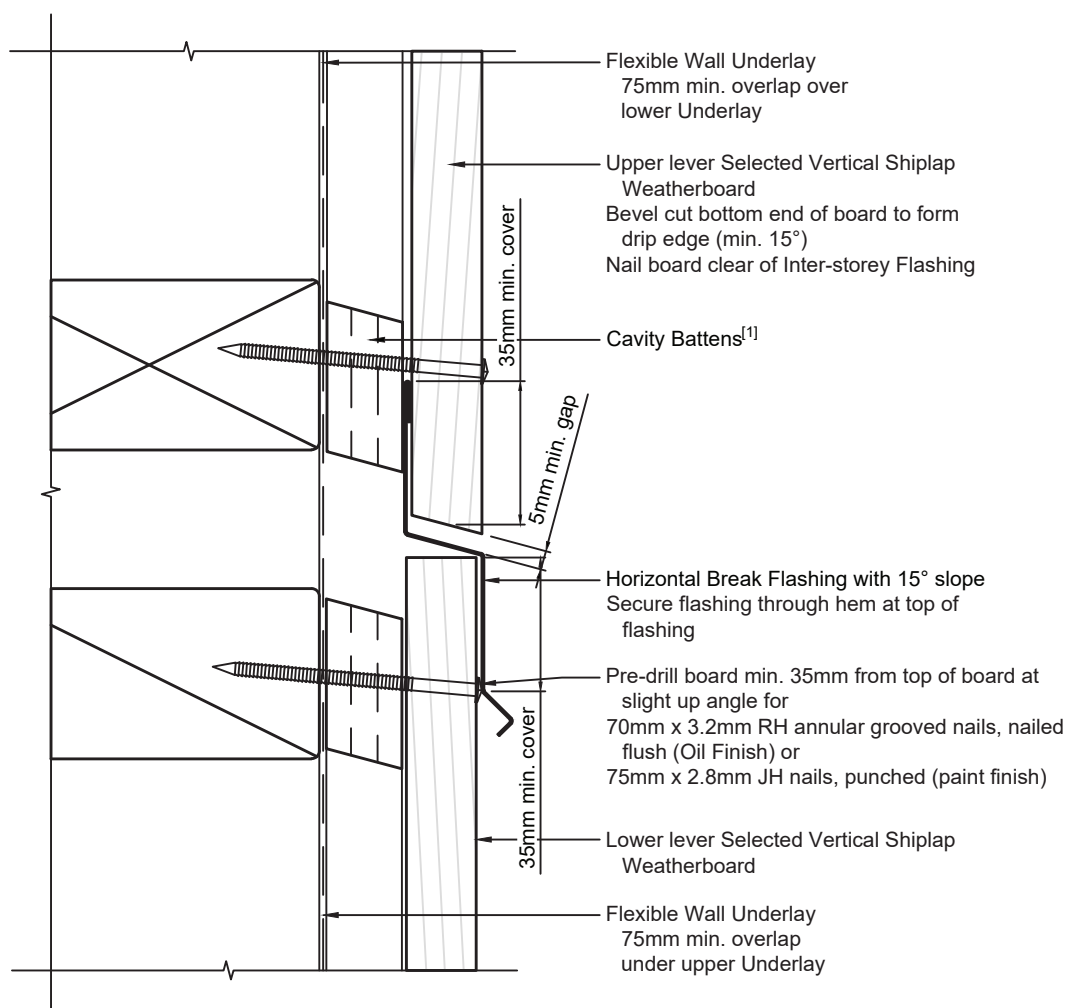

Typical Parapet Detail

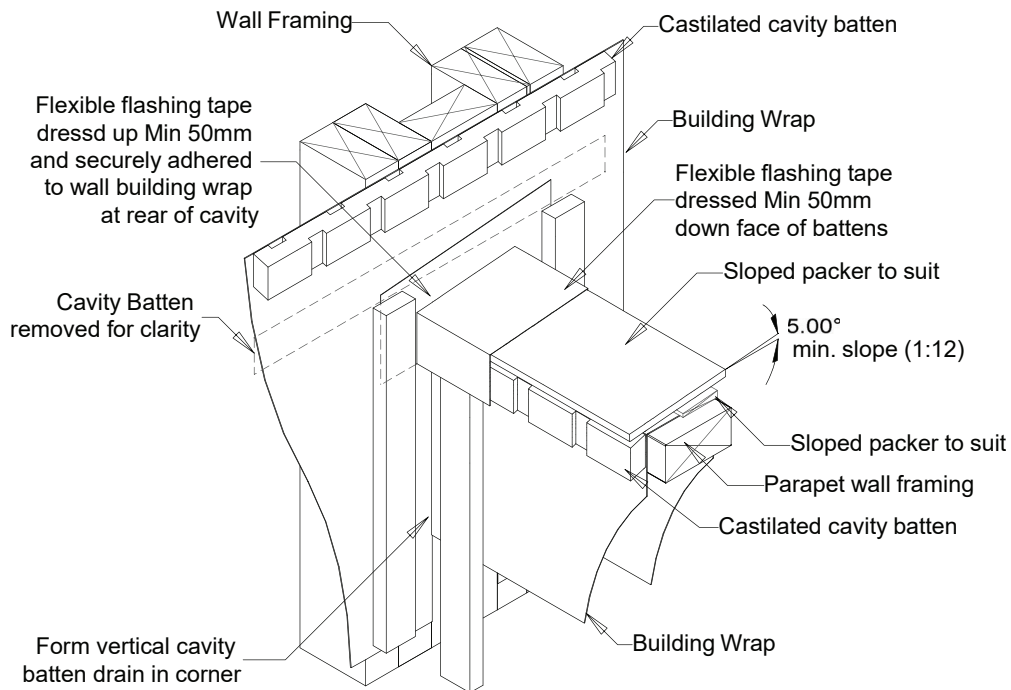
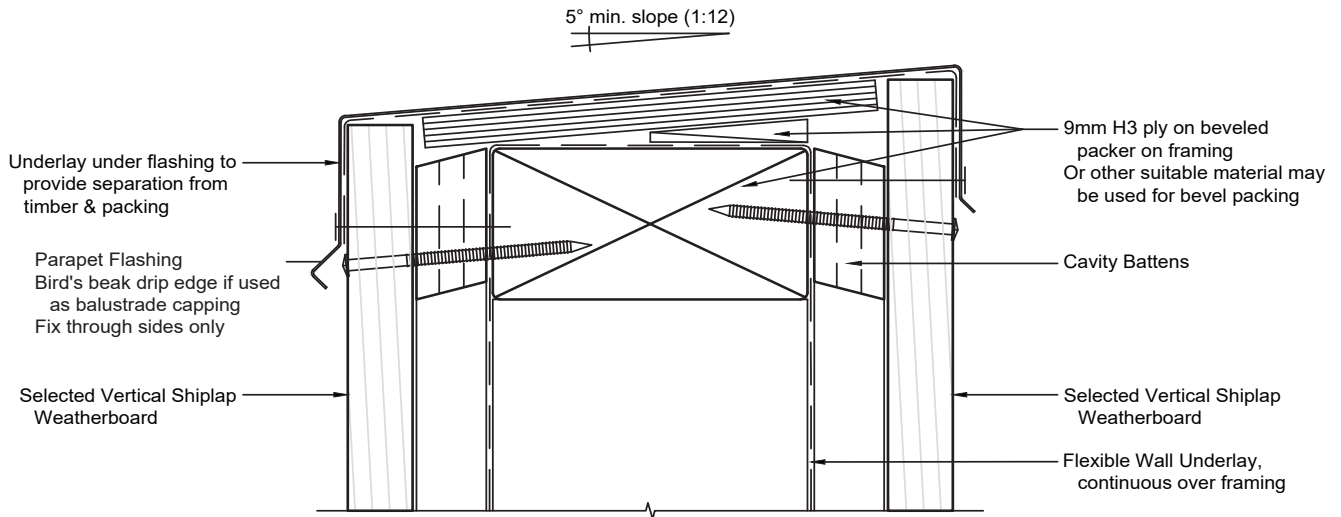

FEXIBLE FLASHING INSTALLATION (DETAIL 1)

Typical Parapet Detail

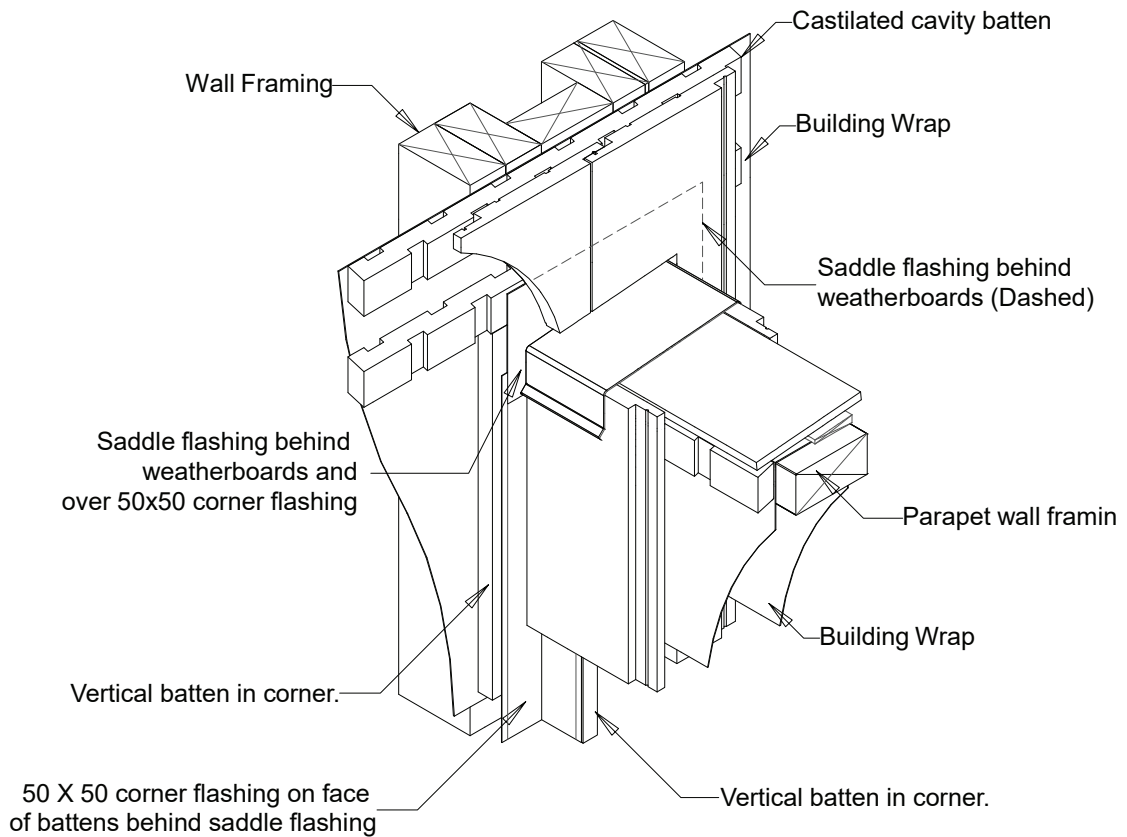

SADDLE FLASHING (DETAIL 2)

Typical Pipe Penetration Detail

