



SIMPLEX[®]
E-PLEX[®]

5000 Series





The Complete
TOOLKIT
For Access Control.

AUDIT REPORT
ACCESS SCHEDULES

PROX BY
HID

SIMPLEX® / E-PLEX® The Simplex and E-Plex 5000 Series is the complete toolkit for all your access control needs. Built on five decades of reliable and convenient keyless entry, this Series provides everything from the simplicity of mechanical single code access to the added security and features of electronic access control.

Meet All Your Needs With The Simplex and E-Plex 5000 Series

- Cylindrical, mortise or exit trim locking options
- PIN, PROX or dual credential access
- Single or multiple access codes
- Easy-to-use software available to simplify management of doors and access users
- Available features include audit trails, access schedules, remote unlock, passage and privacy
- Quick and easy through-bolt installation – no wiring to or through the door

EASY TO INSTALL, EASY TO MAINTAIN

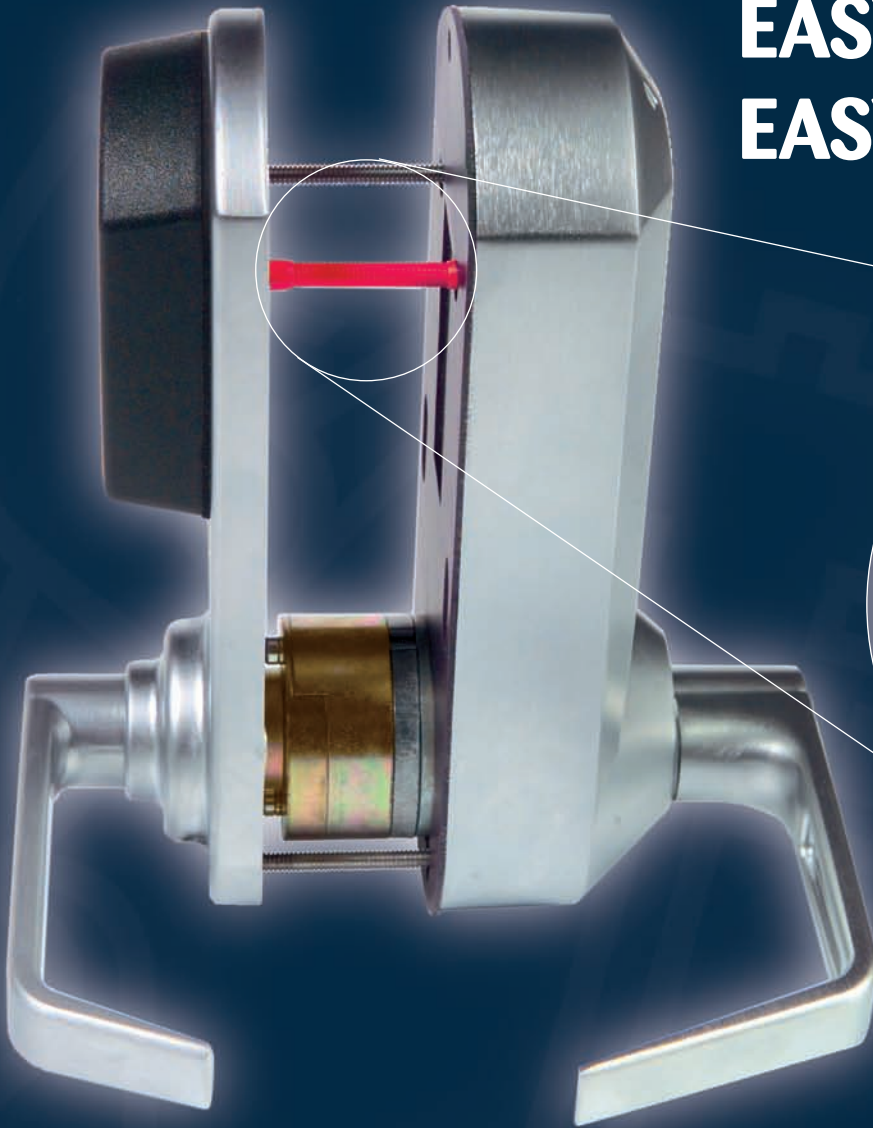

LECTROBOLT®



E-Plex's Patented LECTROBOLT™ eliminates running wires to or through the door – no risk of damage from pinched wires that can result in costly callbacks.

Four bolt installation

No Wiring

One door prep

- Common template lets you change from mechanical to electronic, or electronic to mechanical – with ease
- Universal Exit Trim Mount – fits most leading brands of exit devices

Installs easily on wood or metal doors

Interchangeable knobs and levers

Non-handed / field reversible – fits both left- and right-hand doors

Extra heavy-duty locks provide unparalleled strength













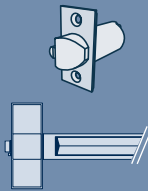
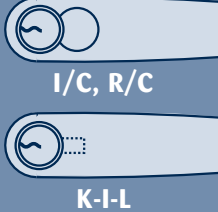

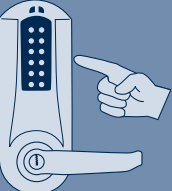
ANSI / BHMA Grade I Certified

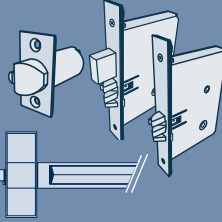
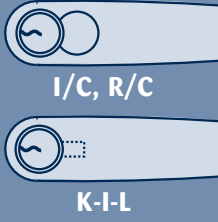
Both housings are rugged and weather-resistant – can be mounted outdoors, no installation gaskets required

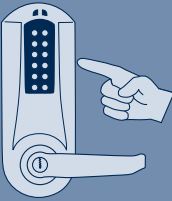
Outstanding technical support team with excellent reputation

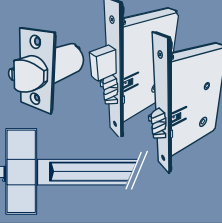
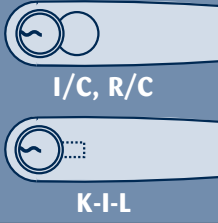
Three-year warranty

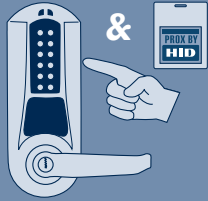
A SOLUTION FOR EVERY DOOR

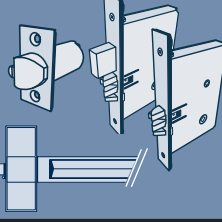
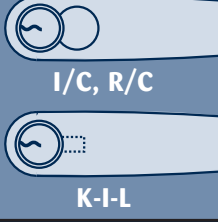
ELECTRONIC	MECHANICAL	SIMPLEX[®] 5000 		 SINGLE CODE		 I/C, R/C K-I-L
		E-PLEX[®] 5000 		 100 CODES		 I/C, R/C K-I-L
		E-PLEX[®] 5200 		 3,000 CODES		 I/C, R/C K-I-L
		E-PLEX[®] 5700 	 & 	 3,000 CODES/CARDS		 I/C, R/C K-I-L
		ACCESS CREDENTIALS	NUMBER OF ACCESS CODES	LOCKING DEVICE OPTIONS	KEY OVERRIDE	

E-PLEX[®]

Electronic access control

No wire installation – to or through the door

Multiple authority levels give you control over who has access to specific features

- Master level – can perform all setup and programming functions
- Manager / Maintenance level – can administrate common programming functions
- Authorized access user level
- Service level – codes for single event or single day access
- Visitor management – for access up to one-year with expiry (E-Plex 5200 and 5700)

Programmable Lock Functions

- Entry lock – normally locked, passage mode can be activated by authorized operator
- Storeroom lock – normally locked, passage mode deactivated
- Residence lock – remains in passage until locked from interior with deadbolt or exterior key command
- Privacy lock – activated from inside, restricts entry to privileged master or manager level user, or key override
- Remote unlock (optional) – from up to 100 feet away

SIMPLEX®

Mechanical pushbutton lock

Simple, single access code











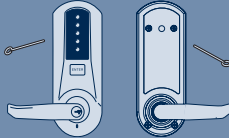

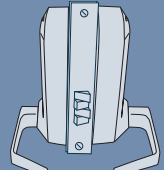

No batteries

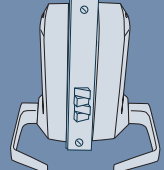
No wiring

Economical

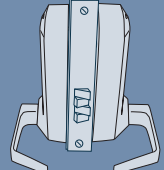
Multiple operation modes

- Single credential (PIN) access
- Passage
- Lockout

	<p>EXTERIOR/INTERIOR COMBINATION CHANGE</p>  <p>KNOB</p> <p>PASSAGE</p>				
	<p>ENTRY/EGRESS</p>  <p>PRIVACY</p> <p>KNOB</p> <p>REMOTE RELEASE</p>	 <p>OPTIONAL</p>	 <p>3,000 EVENTS</p>		
	<p>ENTRY/EGRESS</p>  <p>PRIVACY</p> <p>KNOB</p> <p>REMOTE RELEASE</p>		 <p>30,000 EVENTS</p>	 <p>SCHEDULES</p>	
	<p>ENTRY/EGRESS</p>  <p>PRIVACY</p> <p>KNOB</p> <p>REMOTE RELEASE</p>		 <p>30,000 EVENTS</p>	 <p>SCHEDULES</p>	
<p>CERTIFICATIONS</p>	<p>OPTIONS</p>	<p>SOFTWARE PROGRAMMING</p>	<p>AUDIT CAPABILITIES</p>	<p>ACCESS SCHEDULES</p>	

Easy-to-Use Software

- Simplifies management of doors and access users
- Match each door and user's access requirement to security needs
- Point and click software lets you manage users
- Settings are easily cloned permitting quick multi-lock set-ups
- Up to 32 holiday and vacation blocks (E-Plex 5200 and 5700)
- Up to 16 access schedules (E-Plex 5200 and 5700)

Wireless Communication

- No cables are needed to upload and download your data

- Communicates through infrared data transfer function of a handheld PDA (personal digital assistant)
- Fully contained E-Plex electronics module eliminates repair hassles

FINISHES

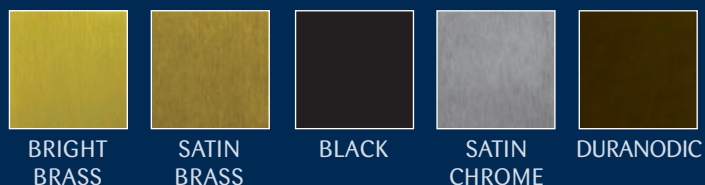

SPECIFICATIONS

Locking Trims

Cylindrical Latch (with optional privacy thumbturn)

- 1/2" (13mm) throw latch, floating face plate
- optional 3/4" (19mm) throw latch, beveled face plate
- 2 3/4" backset

Mortise (available on E-Plex only)

- ASM with 1" (25mm) or 1 1/4" (32mm) faceplate; with and without deadbolt

Rim Exit Device Trim

Construction

Mechanical construction: Extra heavy-duty lock; solid cast housings; solid cast levers

Numeric keypad: Vandal resistant, metal keys

Installation

Door Thickness:

- Cylindrical: 1 3/8" (35mm) to 2 1/4" (57mm)
- Mortise: 1 3/4" (44mm) to 2 1/4" (57mm)
- Exit Trim: 1 3/4" (44mm) to 2 1/4" (57mm)
 - Pre-assembled to accommodate doors 1 5/8" (41mm) to 2" (51mm)
 - Hardware kits included to accommodate thin and thick doors

Non-Handed / Field Reversible

- Pre-assembled for left-hand door installations – easily changed in the field

Minimum Stile Required: 5" (127mm)

Finishes

Five attractive finishes to blend with any decor – Bright Brass, Satin Brass, Satin Chrome, Black, Duranodic, and Bright Chrome

Key Override Options

Key-in-Lever / Knob Cylinders (cylinder included)

- Tailpieces included for compatibility with models by Abloy, Arrow, ASSA, Corbin Russwin, Kaba, Medeco, Sargent, Schlage, and Primus (see catalog for specific model details)

Small Format Interchangeable Core

- Configured for Best and compatibles (6 or 7-pin length)

Large Format Interchangeable Cores

- Available configurations for Schlage, Medeco, ASSA, Yale (6-pin), Sargent and Corbin Russwin

Batteries (E-Plex models only)

(4) four AA Alkaline batteries

- Provides quick and easy battery replacements for institutions
- Lock data is retained if batteries fail
- Long battery life – up to 180,000 cycles

Certification and Testing

Accessibility standard: Americans with Disabilities Act (ADA)

Latch fire rating: Three-hour U.L./U.L.C. Fire Door Rating

Durability: ANSI/BHMA A156.2, and .25 (where applicable)

BHMA Grade 1 Certification

(See BHMA Directory for listing of Grade 1 Certified Simplex and E-Plex.)

Environmental: Indoor/Outdoor

- Front housing: -31 °F (-35 °C) to +151 °F (66 °C)
- Rear housing: -31 °F (-35 °C) to +130 °F (55 °C)

Customizable User Preferences (E-Plex models only)

2 to 20 second relock time

4 to 8 digit user codes

Anti-tamper (disables lock after multiple invalid code entries)

KAA1051 0906