

1.2



BEYOND SECURITY

KABA[®]

Plate Furniture

100 Series, 600 Series, Narrow Style,
1500 Series, 2900 Series



OCTOBER 2014

Plate furniture

Kaba Australia's range of plate furniture is best suited to commercial applications due to the furniture's hard wearing design and features.

All of our plate furniture series have been designed for use with Kaba mortice locks and latches but are also compatible with similar locks and tubular latches.





INDEX

Plate Furniture

- 2 Finishes, Fire Rating and Disabled Access details
- 3 Plate furniture overview and door handing

100 Series and 600 Series

- 4 Ordering details
- 5-6 100 Series details and dimensions
- 7-8 100 Series round end functions
- 9-10 600 Series details and dimensions
- 11-12 600 Series square end functions

N100 and N600 Narrow Style Series

- 13 Ordering details
- 14-15 N100 and N600 Series details and dimensions
- 16 N100 Series - round end functions
- 17 N600 Series - square end functions

1500 Series

- 18 Ordering details
- 19-20 1500 Series details and dimensions
- 21-24 1500 Series functions

2900 Series

- 25 Ordering details
- 26 2900 Series overview
- 27-28 W2900 Series details and dimensions
- 29-32 W2900 Series Plate Functions
- 33-34 N2900 Series Plate details and dimensions
- 35-37 N2900 Series Plate functions



Our plate furniture has been designed for use with Australian mortice locks and latches and is available in a variety of configurations including, concealed and visible fixing, with cylinder hole and with AS1428 compliant levers and turn snibs.

Finishes



SCP Satin Chrome Plate

- > 100 Series
- > 600 Series
- > Narrow Style Series



CP Chrome Plate

- > 100 Series
- > 600 Series



SSS Satin Stainless Steel

- > 1500 Series
- > 2900 Series
Wide and Narrow Style

Fire Rating



The 100, 600, 1500 and 2900 Series have been successfully tested on fire door assemblies to comply with Australian Standard AS1905-1-2005 Part 1, Fire Resistant Door Sets. All testing is carried out by independent laboratories.

Disabled Access



A large selection of our plate furniture complies with AS1428.1 Design for Access and Mobility. Compliance depends on lever and turn snib selections.

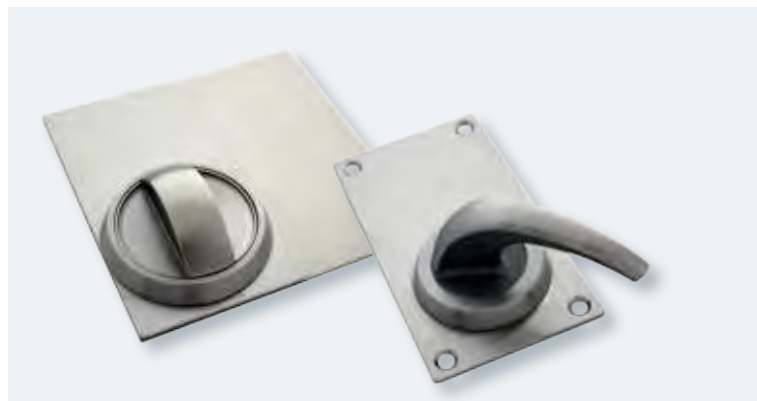

100 Series and 600 Series

Non handed, depending of lever choice and available with a round end (100 Series) or a square end (600 Series) to complement the modern architectural design of Kaba lever handles.

1500 Series

Consisting of flat-form square plates, our 1500 Series plate furniture is constructed of 316 grade stainless steel. Along with lever options, this series offers pulls, knobs and plain plates.

N100 and N600 Narrow Style Series

Our narrow style plate furniture is supplied with our 25 series lever only. The plate itself is available with a round end (N100) or square end (N600).

2900 Series

Our 2900 Series harm minimisation and vandal resistant plate furniture is manufactured from 316 grade stainless steel. This flat-form plate furniture is available in a wide and narrow style configuration.

Handing of Door - British Standards

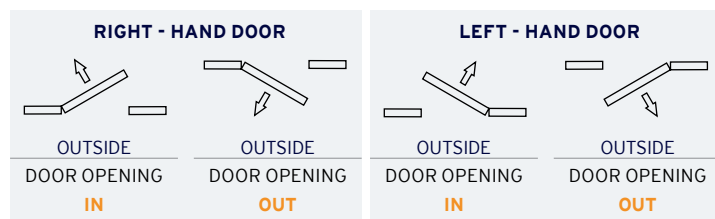

Ordering Details - 100 Series and 600 Series

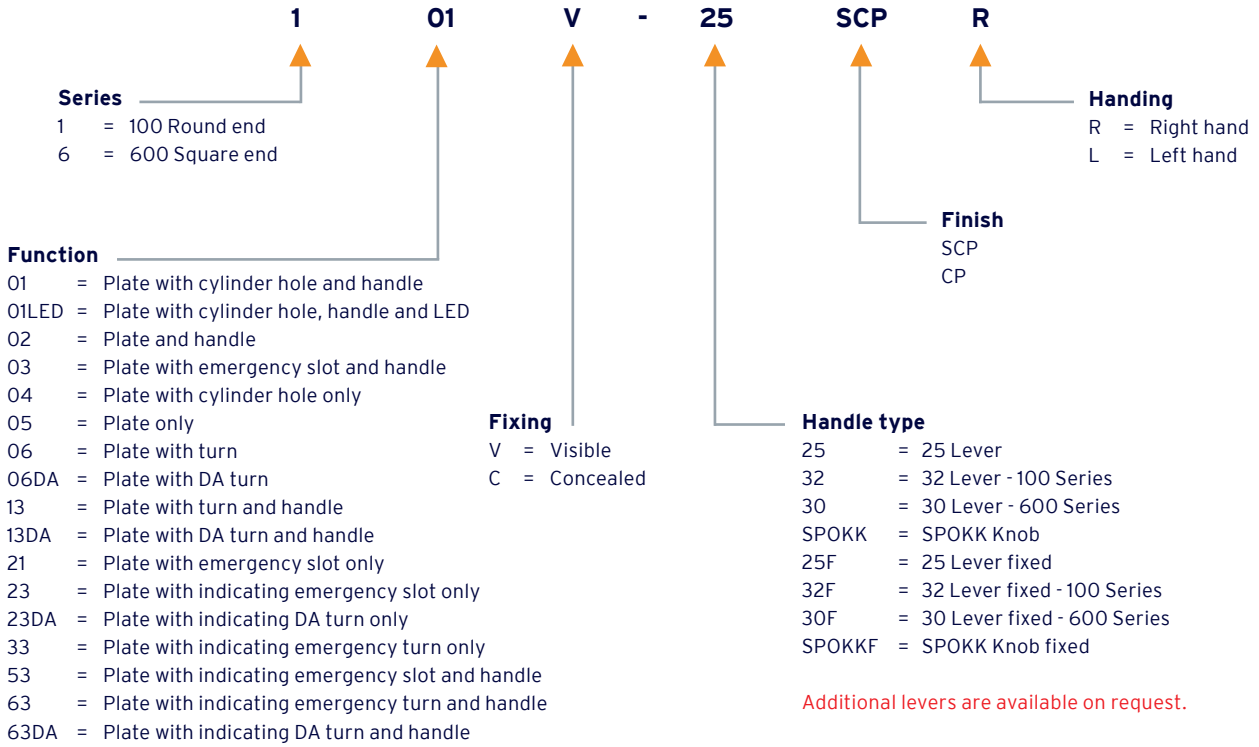

Additional levers are available on request.

Kaba recommends the use of WAFE/TAFE series pull handles where a fixed lever is required.

CODE

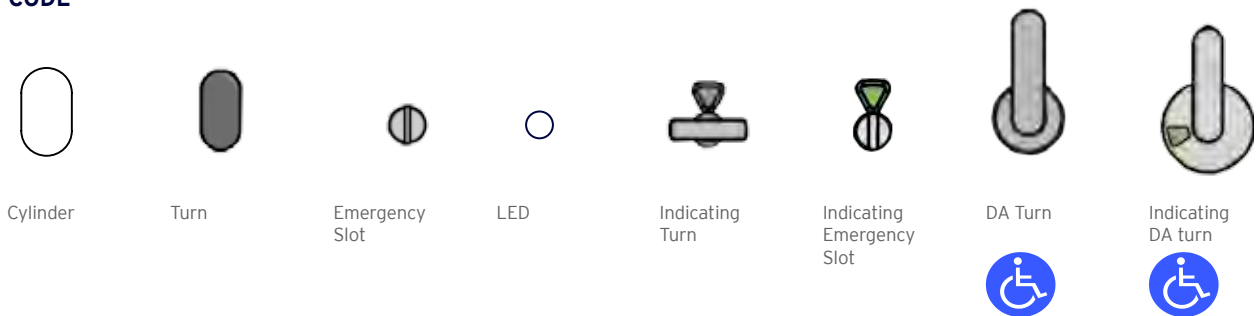

Common handle types





100 Series Plate Furniture

The traditional round end Kaba 100 Series door furniture is best suited for commercial applications due to its hard wearing design and features. The levers or knobs are mounted on a 165mm high x 44mm wide solid forged brass base plate projecting 12mm and are designed for use with Kaba mortice locks and latches and are also compatible with similar locks and tubular latches.

PRODUCT EXAMPLES

					
101C-25SCP Plate with cylinder hole & 25 lever - concealed fix	101C-32SCP Plate with cylinder hole & 32 lever - concealed fix	104CSCP Plate with cylinder hole - concealed fix	113V-25SCP Plate with turn and 25 lever - visible fix	113VDA-25SCP Plate with DA turn snib & 25 lever - visible fix	153C-25SCP Plate with indicating emergency turn & 25 lever - concealed fix

100 Series

Mortice Lock Furniture - Round End

Dimensions

165mm high, 44mm wide, 12mm thick and 149.25mm fixing centres.

Fixing

Plates are designed to fit back to back with the outside plate having concealed fixing. Secured by two M5 cross recessed countersunk screws. Fixing screws supplied in concealed fixing package only.

Construction

The 100 series plate is constructed from a solid forged brass, a corrosion resistant stainless steel cam, an integrated precision ground 9mm bush that provides enhanced handle support and a spring steel wire torsion spring to eliminate handle sag. Levers and knobs are made from either zinc die cast or solid forged brass (refer to lever designs for more information).

Handing

Levers and knobs on the 100 series plates are non-handed and in most cases the levers can be reversed on site (refer to lever designs for more information).

Door Thickness

Standard model is designed to suit 32mm-50mm thick door as standard. Thick door kits available on request (TDK1).

Fire Rating

The 100 Series plate furniture is Fire Rated and complies with Australian Standard AS1905-1-2005 Part 1.



Disabled Access

A selection of the 100 Series plate furniture complies with AS1428 - Design for Access and Mobility, depending on lever handle and turn snib selection.



Functions

Refer to plates and function illustrations for specific details.

Note: For fixed lever options Kaba also recommends the use of the Wafe pull handle series (to match 100 series) in the Pull handle section of this catalogue

Finishes

Satin Chrome Plate SCP
Other finishes on application

Accessories

Code	Description
400-033	Cam - fixed lever 100/600
100-002	Spring - lever return spring 100/600
100-012	Screw pack 100/600.
TDK1	Thick door kit, 50-80mm suit 100/600

SPECIFICATION

The furniture plate should be rectangular in shape with round ends, constructed of forged brass and is 165mm high x 44mm wide x 12mm deep. Having a cam, stop plate and stop screw made from corrosion resistant stainless steel with a spring steel wire torsion spring. The plate is to have a bearing surface for the handle not less than 9mm in depth. The furniture is to have back to back fixing with visible screws fitted on the inside face of the door (where applicable). Fixing screws for the furniture are to be M5 countersunk with cross recessed heads.

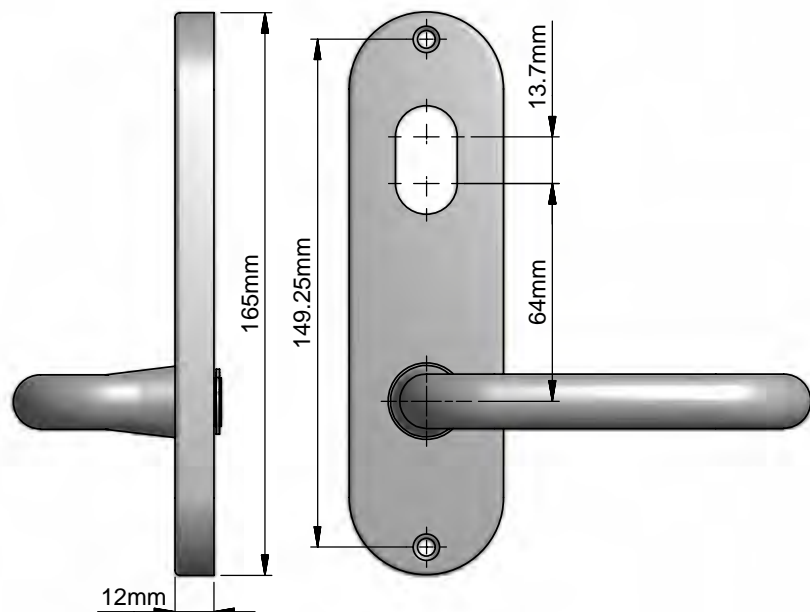

100 Series Round End Plate Range - Functions

Plates with Lever

Note: Plates supplied as standard with a 25 or 32 lever. Different lever designs are available on request.
The standard finish is satin chrome plate (SCP). Other finishes available on request.
MTO= Made to Order, these items are available as a special order

101 Function

Plate with cylinder hole and handle

Note: non-handed

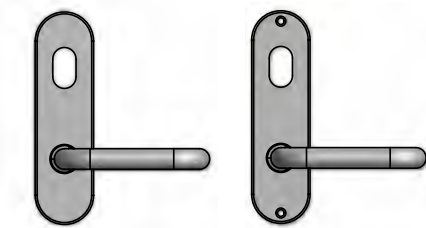

CONCEALED	VISIBLE
25 LEVER	
101C-25SCP	101V-25SCP
32 LEVER	
101C-32SCP	101V-32SCP

101LED Function

Plate with cylinder hole, handle and LED indicator

Note: non-handed

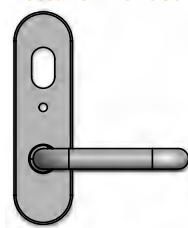

CONCEALED	VISIBLE
25 LEVER	
101CLEd-25SCP	MTO
32 LEVER	
101CLEd-32SCP	MTO

102 Function

Plate and handle

Note: non-handed

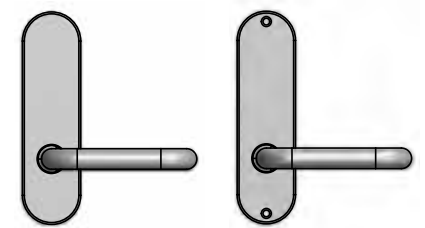

CONCEALED	VISIBLE
25 LEVER	
102C-25SCP	102V-25SCP
32 LEVER	
102C-32SCP	102V-32SCP

103 Function

Plate with emergency slot and handle

Note: non-handed

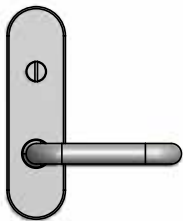

CONCEALED	VISIBLE
25 LEVER	
103C-25SCP	MTO
32 LEVER	
103C-32SCP	MTO

113 Function

Plate with turn and handle

Note: non-handed

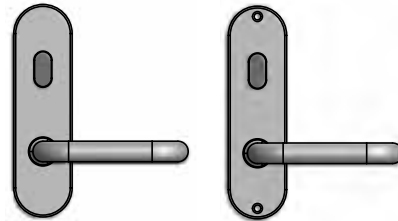

CONCEALED	VISIBLE
25 LEVER	
113C-25SCP	113V-25SCP
32 LEVER	
113C-32SCP	113V-32SCP

113DA Function

Plate with DA turn and handle

Note: handed, field reversible

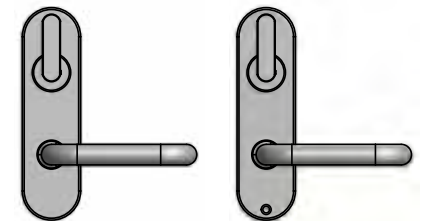

CONCEALED	VISIBLE
25 LEVER	
113CDA-25SCP	113VDA-25SCP
32 LEVER	
113CDA-32SCP	113VDA-32SCP

153 Function

Plate with indicating emergency slot and handle

Note: non-handed

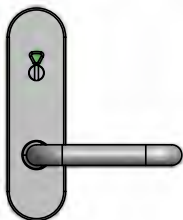

CONCEALED	VISIBLE
25 LEVER	
153C-25SCP	MTO
32 LEVER	
153C-32SCP	MTO

163 Function

Plate with indicating emergency turn and handle

Note: non-handed

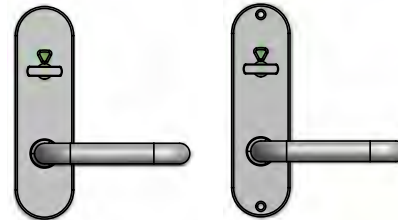

CONCEALED	VISIBLE
25 LEVER	
163C-25SCP	163V-25SCP
32 LEVER	
163C-32SCP	163V-32SCP

163DA Function

Plate with indicating DA turn and handle

Note: handed ** specify Left or Right

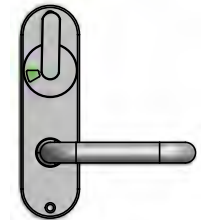

CONCEALED	VISIBLE
25 LEVER	
MTO	163VDA-25SCP**
32 LEVER	
MTO	163VDA-32SCP**

100 Series Round End Plate Range - Functions

Plates without Lever

104 Function

Plate with cylinder hole only

Note: non-handed

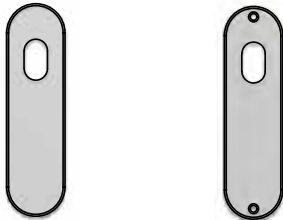

CONCEALED
104CSCP

VISIBLE
104VSCP

105 Function

Plate only

Note: non-handed

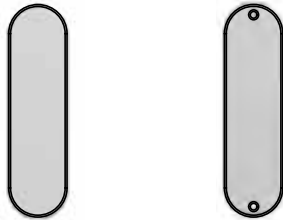

CONCEALED
105CSCP

VISIBLE
105VSCP

106 Function

Plate with turn only

Note: non-handed



CONCEALED
MTO

VISIBLE
106VSCP

106DA Function

Plate with DA turn only

Note: non-handed



CONCEALED
MTO

VISIBLE
106VDASCP

121 Function

Plate with emergency slot only

Note: non-handed



CONCEALED
121CSCP

VISIBLE
MTO

123 Function

Plate with indicating emergency slot only

Note: non-handed



CONCEALED
123CSCP

VISIBLE
MTO

123DA Function

Plate with indicating DA turn only

Note: handed ** specify Left or Right



CONCEALED
MTO

VISIBLE
123VDASCP**

133 Function

Plate with indicating emergency turn only

Note: non-handed



CONCEALED
133SCP

VISIBLE
MTO



600 Series Plate Furniture

The traditional square end Kaba 600 Series door furniture is best suited for commercial applications due to its hard wearing design and features. The levers or knobs are mounted on a 165mm high x 44mm wide solid forged brass base plate projecting 12mm and are designed for use with Kaba mortice locks and latches and are also compatible with similar locks and tubular latches.

PRODUCT EXAMPLES

					
601C-25SCP Plate with cylinder hole & 25 lever - concealed fix	601C-30SCP Plate with cylinder hole & 30 lever - concealed fix	604CSCP Plate with cylinder hole - concealed fix	613V-25SCP Plate with turn and 25 lever - visible fix	613VDA-25SCP Plate with DA turn snib & 25 lever - visible fix	653C-25SCP Plate with indicating emergency turn & 25 lever - concealed fix

600 Series

Mortice Lock Furniture - Square End

Dimensions

165mm high, 44mm wide, 12mm thick and 149.25mm fixing centres.

Fixing

Plates are designed to fit back to back with the outside plate having concealed fixing. Secured by two M5 cross recessed countersunk screws. Fixings screws supplied in concealed fixing package only.

Construction

The 600 series plate is constructed from a solid forged brass, a corrosion resistant stainless steel cam, an integrated precision ground 9mm bush that provides enhanced handle support and a spring steel wire torsion spring to eliminate handle sag. Levers and knobs are made from either zinc die cast or solid forged brass (refer to lever designs for more information).

Handing

Levers and knobs on the 600 series plates are non-handed and in most cases the levers can be reversed on site (refer to lever designs for more information).

Door Thickness

Standard model is designed to suit 35mm-50mm thick door as standard. Thick door kits available on request (TDK1).

Fire Rating

The 600 Series plate furniture is Fire Rated and complies with Australian Standard AS1905-1-2005 Part 1.

FIRE RATED



Disabled Access

A selection of the 600 Series plate furniture complies with AS1428.1 - Design for Access and Mobility, depending on lever handle and turn snib selection.



Functions

Refer to plates and function illustrations for specific details.

Note: For fixed lever options Kaba also recommends the use of the Tafe pull handle series (to match 600 series) in the Pull handle section of this catalogue

Finishes

Satin Chrome Plate SCP
Other finishes on application

Accessories

Code	Description
400-033	Cam - fixed lever 100/600
100-002	Spring - Lever return spring 100/600
100-012	Screw pack 100/600
TDK1	Thick Door Kit, 50-80mm suit 100/600

SPECIFICATION

The furniture plate should be rectangular in shape, constructed of forged brass and is 165mm high x 44mm wide x 12mm deep. Having a cam, stop plate and stop screw made from corrosion resistant stainless steel with a spring steel wire torsion spring. The plate is to have a bearing surface for the handle not less than 9mm in depth. The furniture is to have back to back fixing with visible screws fitted on the inside face of the door (where applicable). Fixing screws for the furniture are to be M5 countersunk with cross recessed heads.

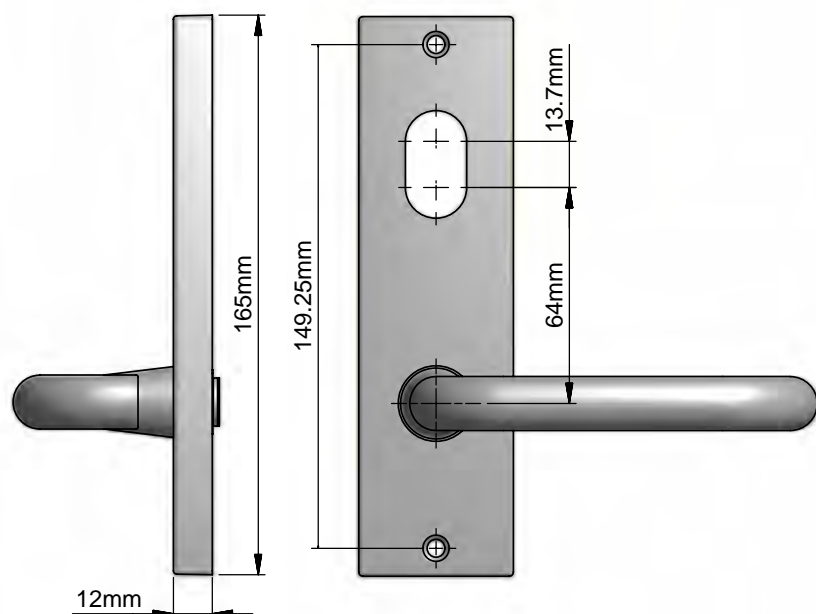

600 Series Square End Plate Range - Functions

Plates with Lever

Note: Plates supplied as standard with a 25 or 32 lever. Different lever designs are available on request.
The standard finish is satin chrome plate (SCP). Other finishes available on request.
MTO= Made to Order, these items are available as a special order

601 Function

Plate with cylinder hole and handle

Note: non-handed

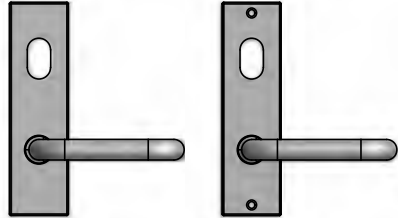

CONCEALED	VISIBLE
25 LEVER	601V-25SCP
601C-25SCP	
30 LEVER	601V-30SCP
601C-30SCP	

601LED Function

Plate with cylinder hole, handle and LED indicator

Note: non-handed

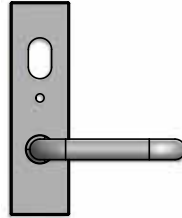

CONCEALED	VISIBLE
25 LEVER	601V-25SCP
601CLED-25SCP	MTO
30 LEVER	601V-30SCP
601CLED-30SCP	MTO

602 Function

Plate and handle

Note: non-handed

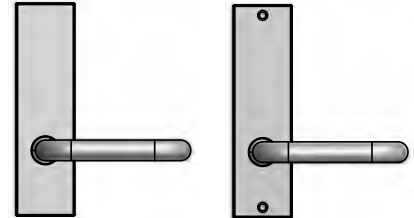

CONCEALED	VISIBLE
25 LEVER	602V-25SCP
602C-25SCP	
30 LEVER	602V-30SCP
602C-30SCP	

603 Function

Plate with emergency slot and handle

Note: non-handed

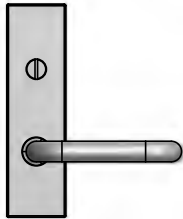

CONCEALED	VISIBLE
25 LEVER	603V-25SCP
603C-25SCP	MTO
30 LEVER	603V-30SCP
603C-30SCP	MTO

613 Function

Plate with turn and handle

Note: non-handed

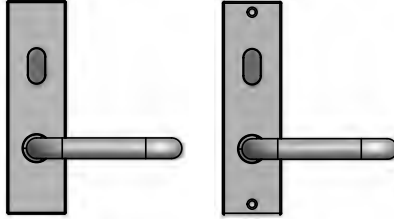

CONCEALED	VISIBLE
25 LEVER	613V-25SCP
613C-25SCP	
30 LEVER	613V-30SCP
613C-30SCP	

613DA Function

Plate with DA turn and handle

Note: handed, field reversible

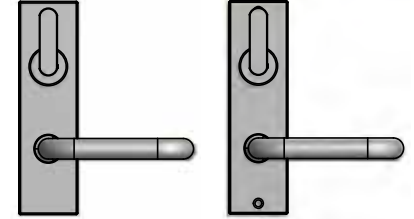

CONCEALED	VISIBLE
25 LEVER	613VDA-25SCP
613CDA-25SCP	
30 LEVER	613VDA-30SCP
613CDA-30SCP	

653 Function

Plate with indicating emergency slot and handle

Note: non-handed

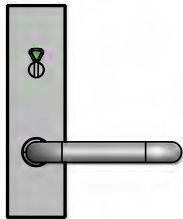

CONCEALED	VISIBLE
25 LEVER	653V-25SCP
653C-25SCP	MTO
30 LEVER	653V-30SCP
653C-30SCP	MTO

663 Function

Plate with indicating emergency turn and handle

Note: non-handed

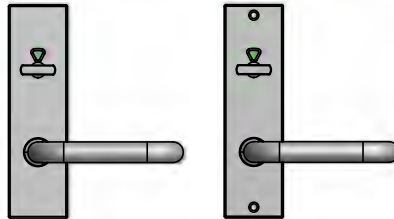

CONCEALED	VISIBLE
25 LEVER	663V-25SCP
663C-25SCP	
30 LEVER	663V-30SCP
663C-30SCP	

663DA Function

Plate with indicating DA turn and handle

Note: handed ** specify Left or Right

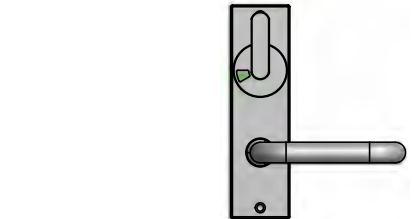

CONCEALED	VISIBLE
25 LEVER	663VDA-25SCP**
MTO	
30 LEVER	663VDA-30SCP**
MTO	

600 Series Round End Plate Range - Functions

Plates without Lever

604 Function

Plate with cylinder hole only

Note: non-handed

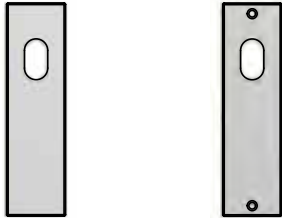

CONCEALED
604CSCP

VISIBLE
604VSCP

605 Function

Plate only

Note: non-handed

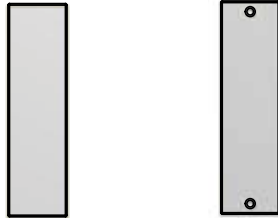

CONCEALED
605CSCP

VISIBLE
605VSCP

606 Function

Plate with turn only

Note: non-handed



CONCEALED
MTO

VISIBLE
606VSCP

606DA Function

Plate with DA turn only

Note: non-handed



CONCEALED
MTO

VISIBLE
606VDASCP

621 Function

Plate with emergency slot only

Note: non-handed



CONCEALED
621CSCP

VISIBLE
MTO

623 Function

Plate with indicating emergency slot only

Note: non-handed



CONCEALED
623CSCP

VISIBLE
MTO

623DA Function

Plate with indicating DA turn only

Note: handed ** specify Left or Right



CONCEALED
MTO

VISIBLE
623VDASCP**

633 Function

Plate with indicating emergency turn only

Note: non-handed



CONCEALED
633SCP

VISIBLE
MTO

Ordering Details - Narrow Style Series (N100 and N600)

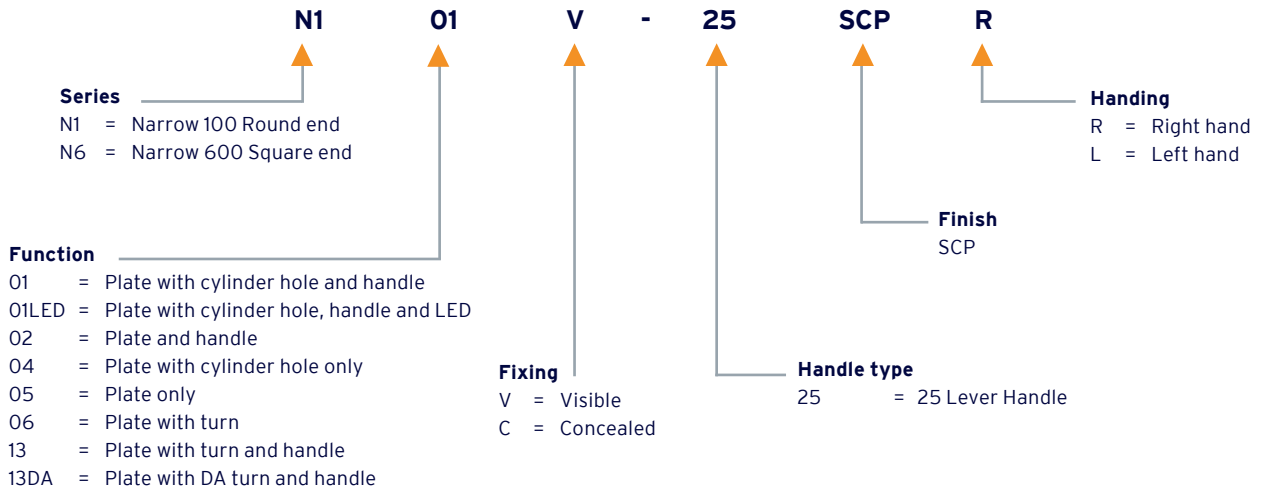

CODE



Cylinder



Turn



LED



DA Turn



Standard handle type



25 Lever standard on both Series



N100 and N600 Narrow Style Series

The Kaba Narrow Style furniture series is designed for use with the Kaba SBM short backset mortice latch and similar products. Available in round end N100 Series and square end N600 Series, our narrow style plate furniture is only available with the 25 lever.

PRODUCT EXAMPLES

N101C-25SCP Plate with cylinder hole & 25 lever - concealed fix	N102V-25SCP Plate with 25 lever - visible fix	N104CSCP Plate with cylinder hole - concealed fix	N606VSCP Plate with turn - visible fix	N613V-25SCP Plate with turn & 25 lever - visible fix	N613VDA-25SCP Plate with DA turn & 25 lever - visible fix

N100 and N600 Narrow Style Series

Mortice Lock Furniture

Dimensions

185mm high, 26mm wide, 12mm thick and 159mm fixing centres.

Fixing

Plates are 12mm thick and are designed to fit back to back with 2 x M4 through fix screws. Concealed fixing to outside and visible fixing to inside. Screws supplied with concealed plates only.

Construction

Constructed from forged brass handles and plates including an integrated precision ground bush providing superior handle support and combined with a heavy duty compression spring eliminates lever handle sag.

Handing

The levers are non-handed & easily converted on site by rotating lever 180°.

Door Thickness

Supplied with 2 x M4, 55mm stainless steel screws and 2 x M4, 68mm stainless steel screws, the Kaba narrow style furniture series is supplied to suit door thickness 32mm to 50mm.

Thicker doors require extended spindles, turn bars & fixing screws.

Fire Rating

The Narrow Style N100 and N600 Series plate furniture (only when used in conjunction with the M Series mortice lock) is Fire Rated and complies with Australian Standard AS1905-1-2005 Part 1.



Disabled Access

A selection of the Narrow Style Series plate furniture complies with AS1428 - Design for Access and Mobility, depending on turn snib selection.



Lever Designs

Plates are only available in the 25 lever handle design. Optional 190-080 fixed lever cam available as accessory (requires installation).

Finishes

Satin Chrome Plate SCP

Accessories

Code	Description
SP-NSF	Screw Pack - Suit N100/N600 Narrow Style Furniture SSS
190-080	Cam - Fixed lever N100/N600 Series

SPECIFICATION

The furniture plate should be rectangular in shape (radius ends for N100 series), constructed of forged brass and is 185mm high x 26mm wide x 12mm deep. Having a cam, stop plate and stop screw made from corrosion resistant stainless steel with a spring steel wire compression spring. The plate is to have a bearing surface for the handle not less than 9mm in depth. The furniture is to have back to back fixing with visible screws fitted on the inside face of the door (where applicable). Fixing screws for the furniture are to be M4 countersunk with cross recessed heads.

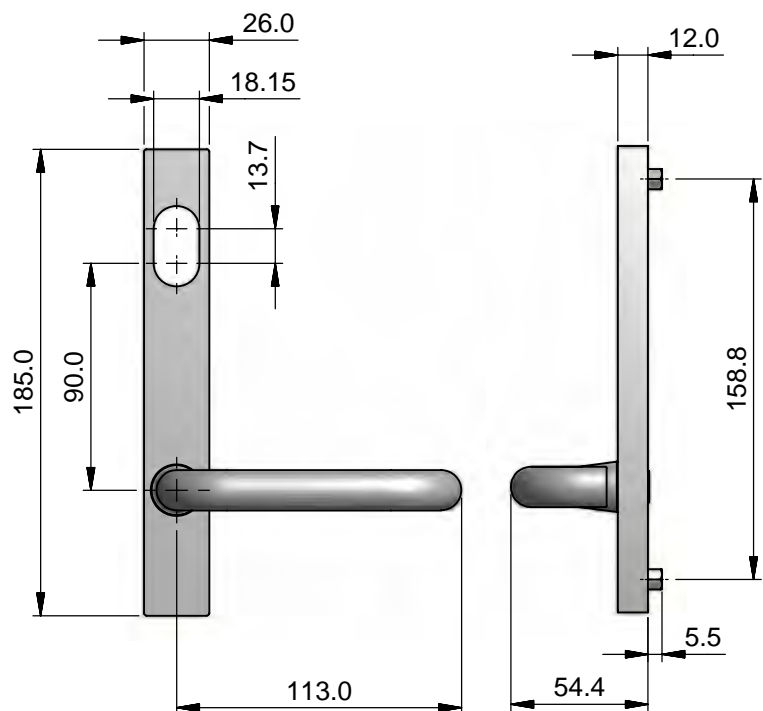

N100 Narrow Style Series Round End Plate Range - Functions

Plates with Lever

Note: MTO= Made to Order, these items are available as a special order

N101 Function

Plate with cylinder hole and 25 lever

Note: non-handed

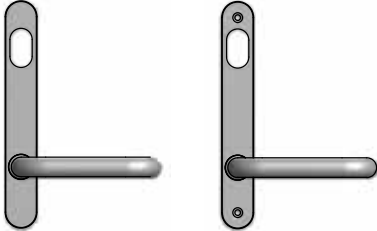

CONCEALED
N101C-25SCP

VISIBLE
N101V-25SCP

N101LED Function

Plate with cylinder hole, LED and 25 lever

Note: non-handed

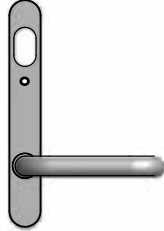

CONCEALED
N101CLEd-25SCP

VISIBLE
MTO

N102 Function

Plate without cylinder hole with 25 lever

Note: non-handed

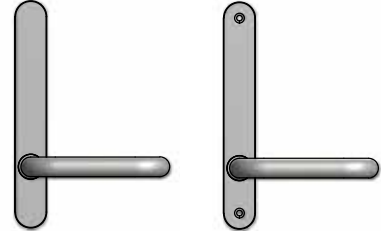

CONCEALED
N102C-25SCP

VISIBLE
N102V-25SCP

N113 Function

Plate with turn and 25 lever

Note: non-handed

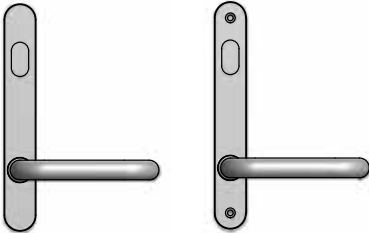

CONCEALED
N113C-25SCP

VISIBLE
N113V-25SCP

N113DA Function

Plate with DA turn and 25 lever

Note: handed, field reversible

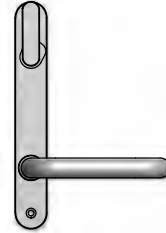

CONCEALED
MTO

VISIBLE
N113VDA-25SCP

Plates without Levers

N104 Function

Plate with cylinder hole only

Note: non-handed

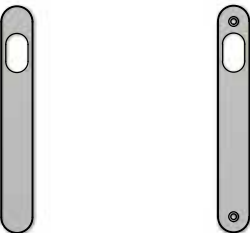

CONCEALED
N104CSCP

VISIBLE
N104VSCP

N105 Function

Plate only

Note: non-handed

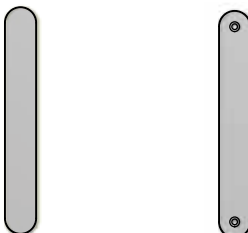

CONCEALED
N105CSCP

VISIBLE
N105VSCP

N106 Function

Plate with turn only

Note: non-handed



CONCEALED
MTO

VISIBLE
N106VSCP

N600 Narrow Style Series Square End Plate Range - Functions

Plates with Lever

Note: MTO= Made to Order, these items are available as a special order

N601 Function

Plate with cylinder hole and 25 lever

Note: non-handed

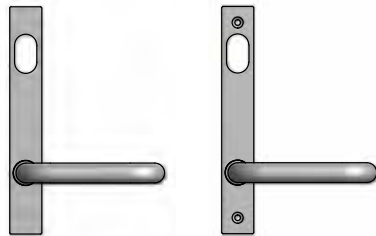

CONCEALED
N601C-25SCP

VISIBLE
N601V-25SCP

N601LED Function

Plate with cylinder hole, LED and 25 lever

Note: non-handed

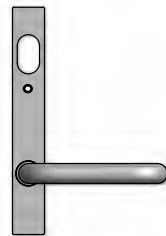

CONCEALED
N601CLEd-25SCP

VISIBLE
MTO

N602 Function

Plate without cylinder hole with 25 lever

Note: non-handed

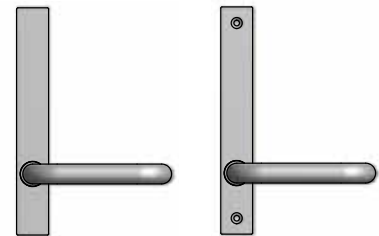

CONCEALED
N602C-25SCP

VISIBLE
N602V-25SCP

N613 Function

Plate with turn and 25 lever

Note: non-handed

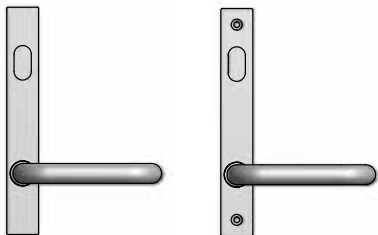

CONCEALED
N613C-25SCP

VISIBLE
N613V-25SCP

N613DA Function

Plate with DA turn and 25 lever

Note: handed, field reversible

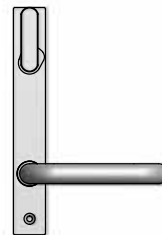

CONCEALED
N/A

VISIBLE
N613VDA-25SCP

Plates without Levers

N604 Function

Plate with cylinder hole only

Note: non-handed

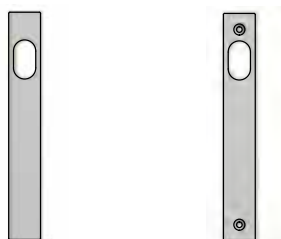

CONCEALED
N604CSCP

VISIBLE
N604VSCP

N605 Function

Plate only

Note: non-handed

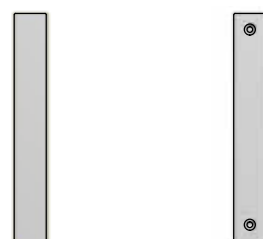

CONCEALED
N605CSCP

VISIBLE
N605VSCP

N606 Function

Plate with turn only

Note: non-handed



CONCEALED
N/A

VISIBLE
N606VSCP

Ordering Details - 1500 Series

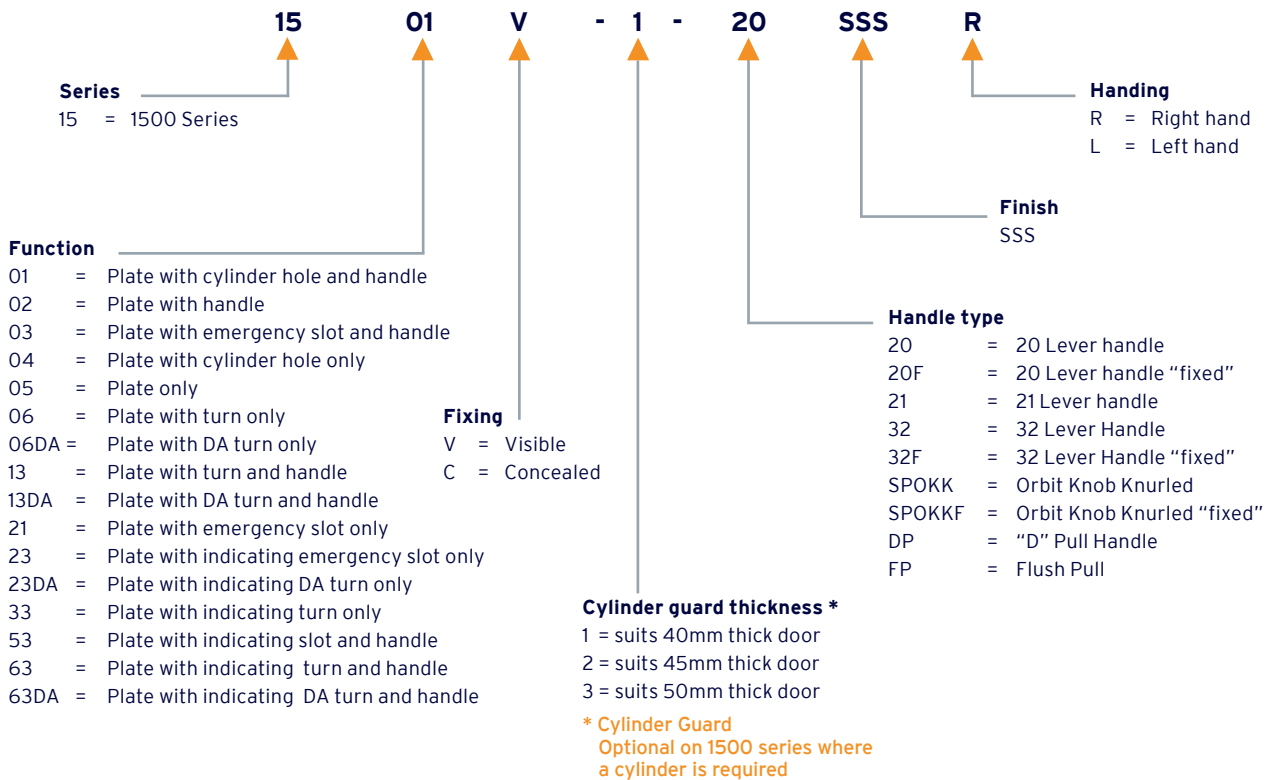

Function codes



Standard handle types

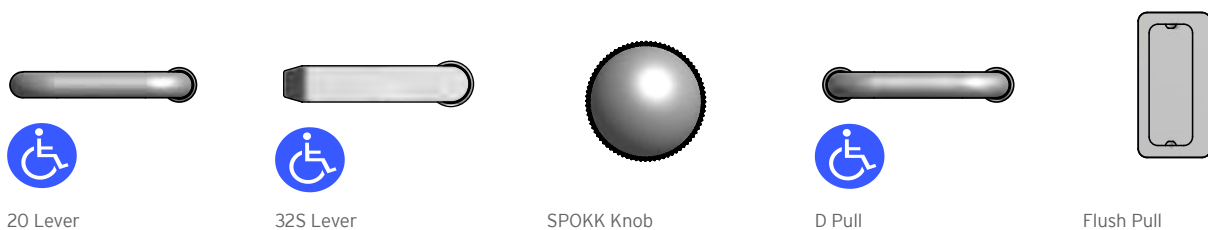



1500 Series Plate Furniture

The Kaba 1500 Series flat form square door furniture is designed for use with Kaba mortice locks or similar locks and latches. The 1500 Series has been manufactured for commercial applications where high traffic and wear is expected. The levers or knobs are mounted on a high quality 316 grade stainless steel sheet metal plate, 160mm x 160mm x 2mm thick.

PRODUCT EXAMPLES



1504CSSS
Plate with cylinder hole only
- concealed fix



1501-20SSS
Plate with cylinder hole & 20 lever
- concealed fix



1513V-SPOKKSSS
Plate with turn and knob
- visible fix



1546C-FPSSS
Plate with Flush Pull
- concealed fix



1501C-DPSSS
Plate with cylinder hole & D Pull
- concealed fix

1500 Series

Mortice Lock Furniture - Square End

Dimensions

160mm high, 160mm wide and 2mm thick.

Fixing

Plates are designed to fit back to back with the outside plate having concealed fixing. Secured by 4 x M5 cross recessed countersunk screws. Optional security screws are available for high risk areas.

Construction

The 1500 Series plate is constructed from a high quality 316 grade stainless steel sheet metal, a corrosion resistant stainless steel cam, an integrated precision ground 8mm stainless steel bush that provides enhanced handle support and strength, a spring steel wire torsion spring to eliminate handle sag and a heavy duty stainless steel stop cam. Levers and knobs are also constructed of a high quality 316 grade stainless steel.

Handing

Plates are handed.

Door Thickness

Standard model is designed to suit 35mm-50mm thick door as standard. For thick doors extended screw packs are required.

Fire Rating

The 1500 Series plate furniture is fire rated and complies with Australian Standard AS1905-1-2005 Part 1.



Disabled Access

A selection of the 1500 Series plate furniture complies with AS1428 - Design for Access and Mobility, depending on lever handle and turn snib selection.



Functions

See Function Chart for all functions.

Lever and knob designs

Standard lever is No. 20 and Knob is SPOKK (Special orbit knurled knob). Other levers available on request are No. 32S and No. 21. All levers and knobs are spring assisted for positive operation.

Finishes

Satin Stainless Steel SSS

Accessories

Code	Description
100-009	Screw Pack - 1500 Series
TDK2	Thick Door Kit, 50-80mm suit 1500
150-000	Cam - 1500 Series
PTS	Post Torx Screws (M5) pkt 4
150-010	Spring - Lever return, 1500 Series

SPECIFICATION

The door furniture should be square in shape, 160mm x 160mm x 2mm, manufactured from stainless steel. The corners are to have a 2mm radius, stainless steel cams. The plate is to incorporate an 8mm bearing surface. The screws are to be a countersunk stainless steel M5 cross recessed type, visible only from the non-secure face of the door.

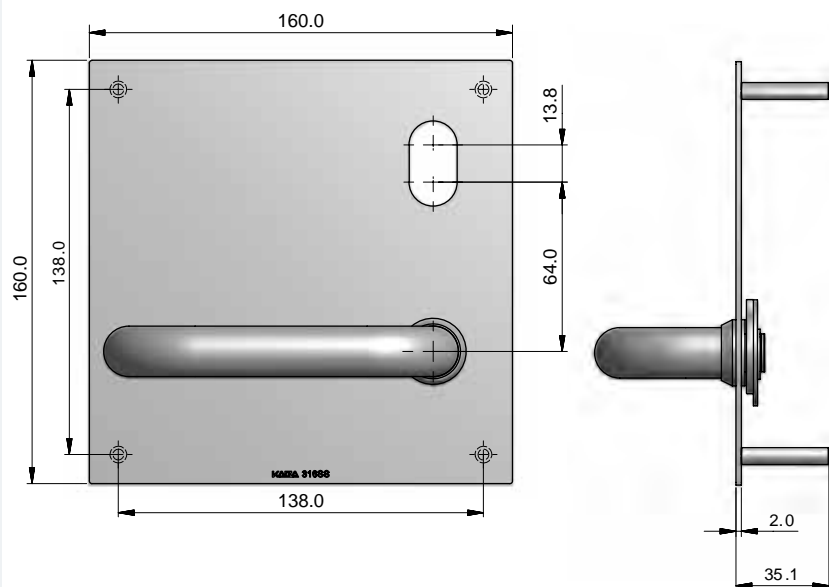

1500 Series Plate Range - Functions

Plates with 20 Lever

Note: Illustrations are shown as right handed plates, all plates are handed ** unless specified
MTO= Made to Order, these items are available as a special order

1501 Function

1500 plate with cylinder hole and 20 lever

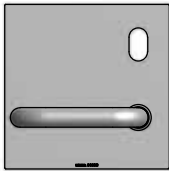

CONCEALED
1501C-20SSS**

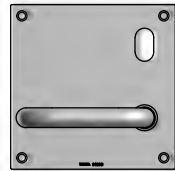

VISIBLE
1501V-20SSS**

1502 Function

1500 plate with 20 lever

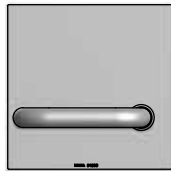

CONCEALED
1502C-20SSS**

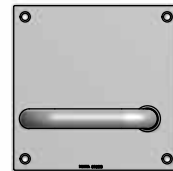

VISIBLE
1502V-20SSS**

1503 Function

1500 plate with emergency slot and 20 lever

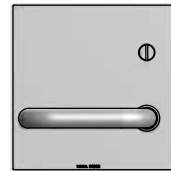

CONCEALED
1503C-20SSS**

VISIBLE
MTO

1513 Function

1500 plate with turn and 20 lever

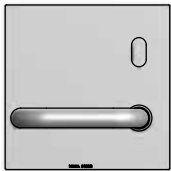

CONCEALED
1513C-20SSS**

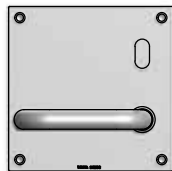

VISIBLE
1513V-20SSS**

1513DA Function

1500 plate with DA turn and 20 lever

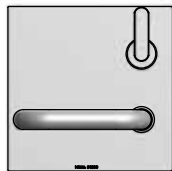

CONCEALED
1513CDA-20SSS**

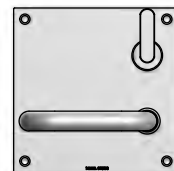

VISIBLE
1513VDA-20SSS**

1553 Function

1500 plate with indicating emergency slot and 20 lever

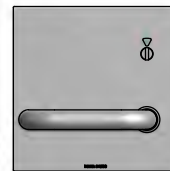

CONCEALED
1553C-20SSS**

VISIBLE
MTO

1563 Function

1500 plate with indicating turn and 20 lever

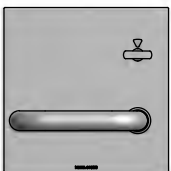

CONCEALED
1563C-20SSS**

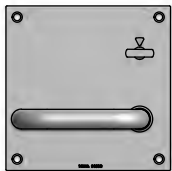

VISIBLE
1563V-20SSS**

1563DA Function

1500 plate with indicating DA turn and 20 lever

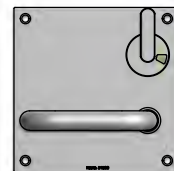

CONCEALED
MTO

VISIBLE
1563VDA-20SSS**

Plates without Handles

1504 Function

1500 plate with cylinder hole

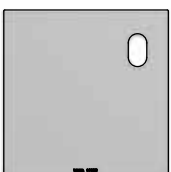

CONCEALED
1504C-SSS**

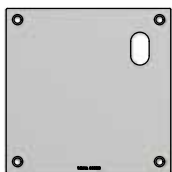

VISIBLE
1504V-SSS**

1505 Function

1500 plain plate

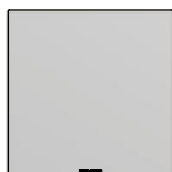

CONCEALED
1505C-SSS

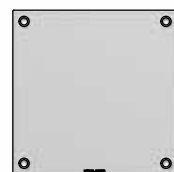

VISIBLE
1505V-SSS

1506 Function

1500 plate with turn

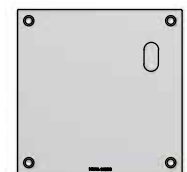

CONCEALED
MTO

VISIBLE
1506V-SSS**

1500 Series Plate Range - Functions

Plates without Handles cont.

Note: Illustrations are shown as right hand, all plates that require handing are listed with ** in part number
MTO= Made to Order, these items are available as a special order

1506DA Function

1500 plate with DA turn

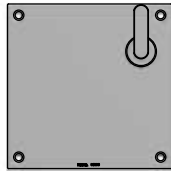

CONCEALED
MTO

VISIBLE
1506VDASSS**

1521 Function

1500 plate with emergency slot

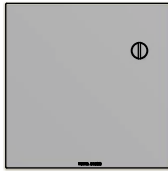

CONCEALED
1521CSSS**

VISIBLE
MTO

1523 Function

1500 plate with indicating emergency slot

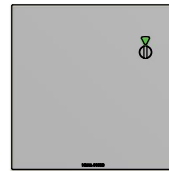

CONCEALED
1523C2SSS**

VISIBLE
MTO

1523DA Function

1500 plate with indicating DA turn

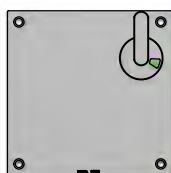

CONCEALED
MTO

VISIBLE
1523VDASSS**

1533 Function

1500 plate with indicating turn

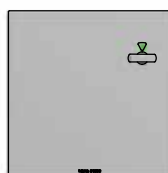

CONCEALED
1533CSSS**

VISIBLE
MTO

Plates with Knob

1501 Function

1500 plate with cylinder hole and SPOKK

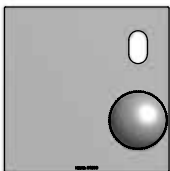

CONCEALED
1501C-SPOKKSSS**

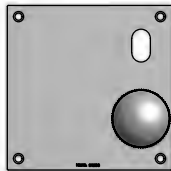

VISIBLE
1501V-SPOKKSSS**

1502 Function

1500 plate with SPOKK

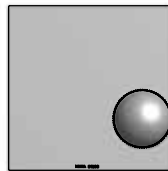

CONCEALED
1502C-SPOKKSSS**

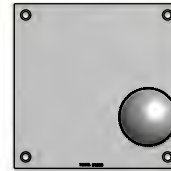

VISIBLE
1502V-SPOKKSSS**

1503 Function

1500 plate with emergency slot and SPOKK

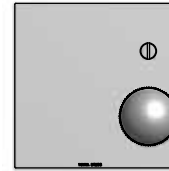

CONCEALED
1503C-SPOKKSSS**

VISIBLE
MTO

1513 Function

1500 plate with turn and SPOKK

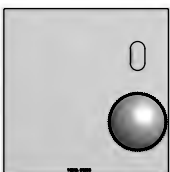

CONCEALED
1513C-SPOKKSSS**

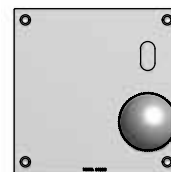

VISIBLE
1513V-SPOKKSSS**

1513DA Function

1500 plate with DA turn and SPOKK

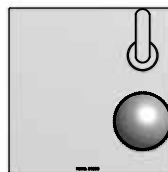

CONCEALED
1513CDA-SPOKKSSS**

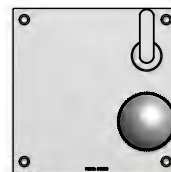

VISIBLE
1513VDA-SPOKKSSS**

1553 Function

1500 plate with indicating emergency slot and SPOKK

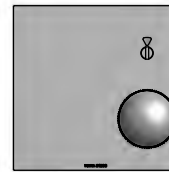

CONCEALED
1553C-SPOKKSSS**

VISIBLE
MTO

1500 Series Plate Range - Functions

Plates with Knob cont.

Note: Illustrations are shown as right handed plates, all plates are handed ** unless specified
MTO= Made to Order, these items are available as a special order

1563 Function

1500 plate with indicating turn and SPOKK

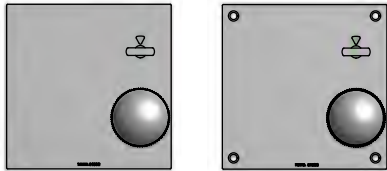

CONCEALED 1563C-SPOKKSSS**
VISIBLE 1563V-SPOKKSSS**

1563DA Function

1500 plate with indicating DA turn and SPOKK

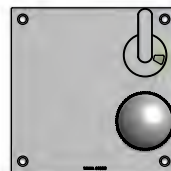

CONCEALED MTO
VISIBLE 1563VDA-SPOKKSSS**

Plates with D-Pull

1501 Function

1500 plate with cylinder hole and D-Pull

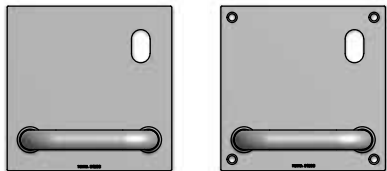

CONCEALED 1501C-DPSSS**
VISIBLE 1501V-DPSSS**

1502 Function

1500 plate with D-Pull

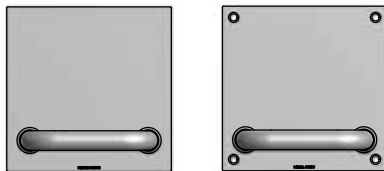

CONCEALED 1502C-DPSSS
VISIBLE 1502V-DPSSS

1503 Function

1500 plate with emergency slot and D-Pull

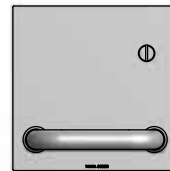

CONCEALED 1503C-DPSSS**
VISIBLE MTO

1513 Function

1500 plate with turn and D-Pull

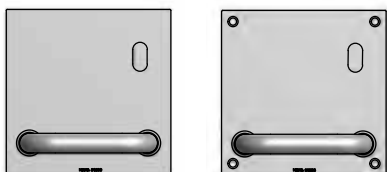

CONCEALED 1513C-DPSSS**
VISIBLE 1513V-DPSSS**

1513DA Function

1500 plate with DA turn and D-Pull

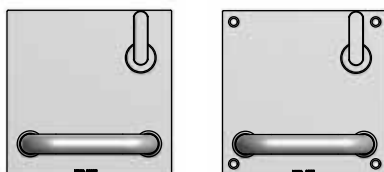

CONCEALED 1513CDA-DPSSS**
VISIBLE 1513VDA-DPSSS**

1553 Function

1500 plate with indicating emergency slot and D-Pull



CONCEALED 1553C-DPSSS**
VISIBLE MTO

1563 Function

1500 plate with indicating turn and D-Pull

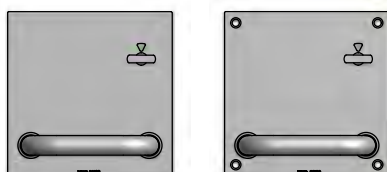

CONCEALED 1563C-DPSSS**
VISIBLE 1563V-DPSSS**

1563DA Function

1500 plate with indicating DA turn and D-Pull

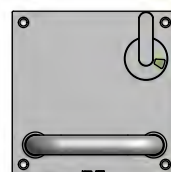

CONCEALED MTO
VISIBLE 1563VDA-DPSSS**

1500 Series Plate Range - Functions

Plates with Flush Pull

Note: Illustrations are shown as right hand, all plates that require handing are listed with ** in part number
MTO= Made to Order, these items are available as a special order

1501 Function

1500 plate with cylinder hole and flush pull

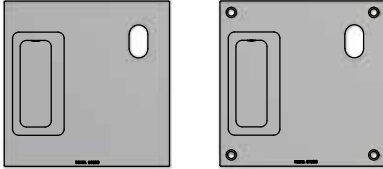

CONCEALED
1501C-FPSSS**

VISIBLE
1501V-FPSSS**

1502 Function

1500 plate with flush pull

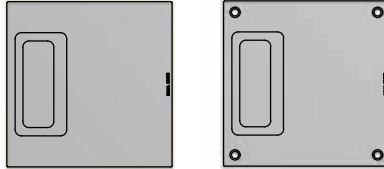

CONCEALED
1502C-FPSSS**

VISIBLE
1502V-FPSSS**

1503 Function

1500 plate with emergency slot and flush pull

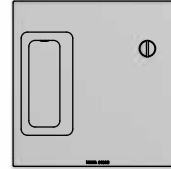

CONCEALED
1503C-FPSSS**

VISIBLE
MTO

1513 Function

1500 plate with turn and flush pull

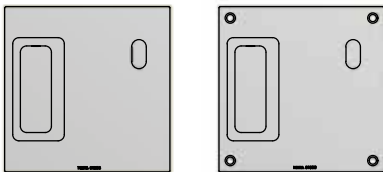

CONCEALED
1513C-FPSSS**

VISIBLE
1513V-FPSSS**

1513DA Function

1500 plate with DA turn and flush pull

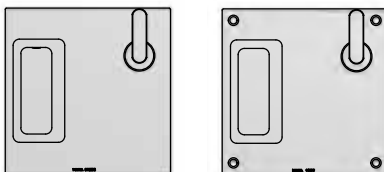

CONCEALED
1513CDA-FPSSS**

VISIBLE
1513VDA-20SSS**

1553 Function

1500 plate with indicating emergency slot and flush pull

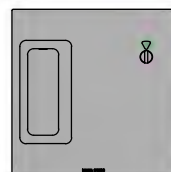

CONCEALED
1553C-FPSSS**

VISIBLE
MTO

1563 Function

1500 plate with indicating turn and flush pull

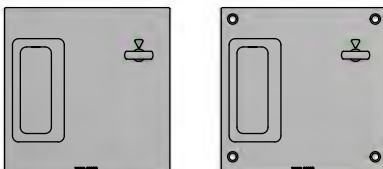

CONCEALED
1563C-FPSSS**

VISIBLE
1563V-FPSSS**

1563DA Function

1500 plate with indicating DA turn and flush pull

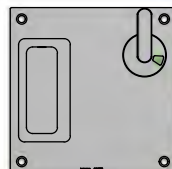

CONCEALED
MTO

VISIBLE
1563VDA-FPSSS**

Ordering Details - 2900 Series

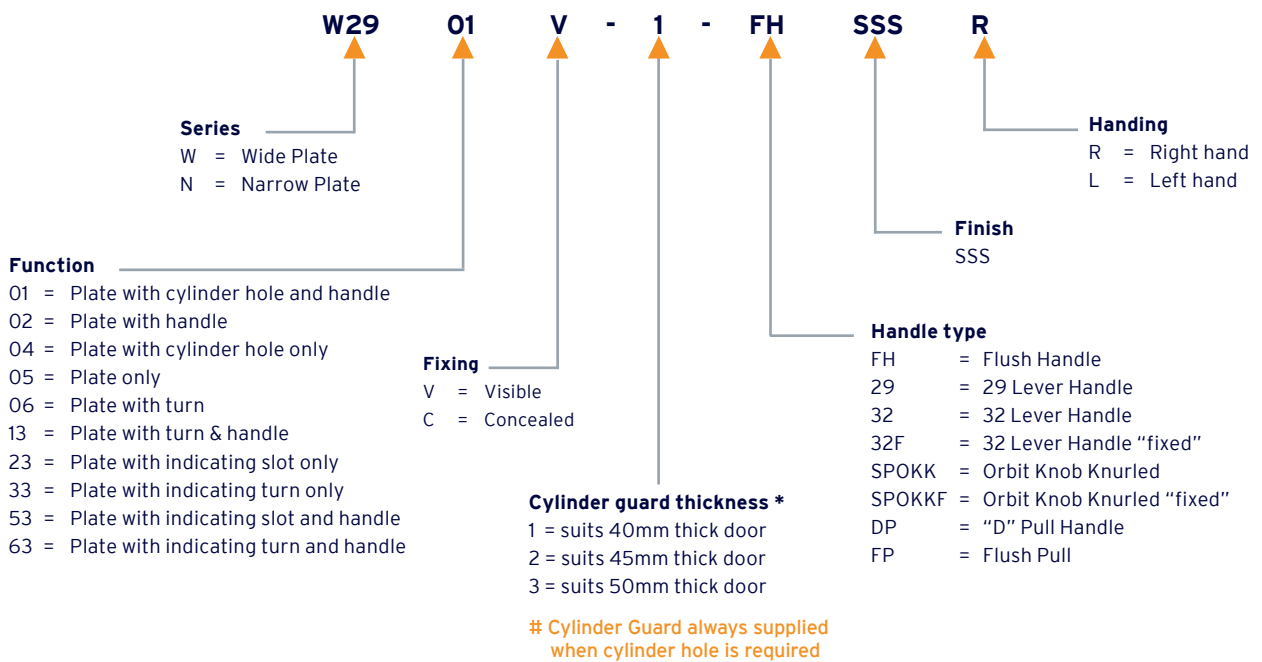

Function codes

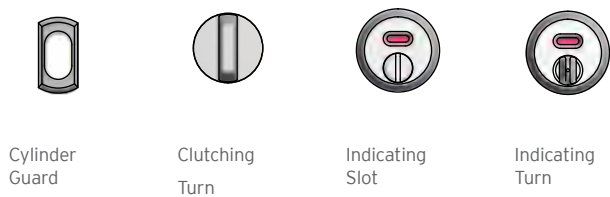

Standard handle types

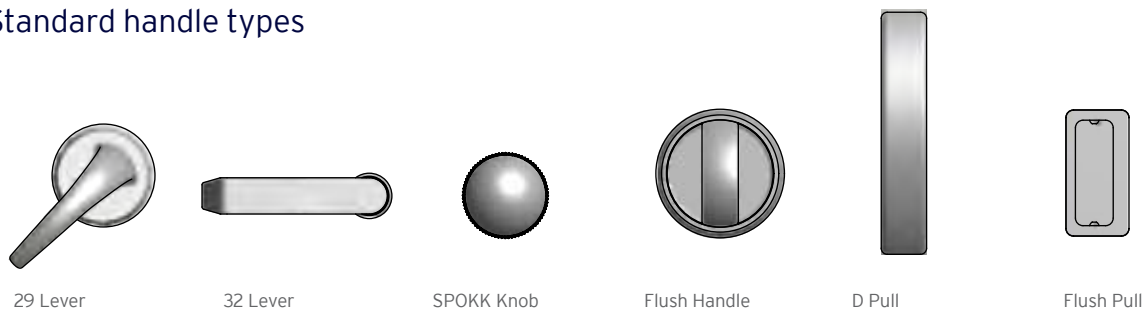

2900 Series Plate Furniture

Harm Minimisation Range

The Kaba 2900 Series flat form square door furniture is designed for use with contemporary Australian mortice locks and latches. For optimal effectiveness, Kaba Australia recommends the use of the MSE extended backset version of mortice lock.

Features

The 2900 Series is a true harm minimisation range and features smooth surfaces and edges, providing minimal ligature and impact points. These same features make the 2900 Series perfect for use in areas where vandalism is a risk.

Using the classic Kaba 1500 Series mortice lock furniture as a basis for its design, the 2900 Series retains all of the features Kaba is known for, such as security, reliability, strength and durability, whilst also maintaining convenience and the aesthetics of the door.

The construction material is high quality 316 grade stainless steel

(except the flush pull "FP", which is brass with a satin nickel plate finish).

All models with cylinder holes come with cylinder guards as standard. Models that require a turn snib are supplied with a patented clutching feature for key over-ride if the turn is held from the inside. All concealed fixed plates are supplied with four post torx anti tamper screws. Snake eyed screws available on request.

Door Thickness

The Kaba 2900 Series plate door furniture suits door thickness from 35mm minimum to 50mm maximum. Thicker doors require extended spindles, turn bars and longer fixing screws.

Application

The product is designed for use with Kaba MS and MSE Series mortice locks, with Kaba recommending the MSE extended backset version for optimal product performance.



W2900 Series Plate Furniture - Wide Plate

The W2900 Series has been manufactured for commercial applications where minimal ligature and impact points are required. The levers or knobs are mounted on a high quality 316 grade stainless steel sheet metal plate.

PRODUCT EXAMPLES



W2901C-1-DPSSSR

Wide - concealed fix
cylinder guard and
D Pull - right hand



W2902C-FHSSSL

Wide - concealed fix
Flush Handle - left
hand



W2902V-SPOKKSSSL

Wide - visible fix
Knurled Knob - left
hand



W2902V-29SSSL

Wide - visible fix
29 lever - left hand



W2902V-32SSSL

Wide - visible fix
32 lever - left hand

W2900 Series

Harm Minimisation Range - Wide Plate

Dimensions

160mm (H), 160mm (W), 4mm (T).

Fixing

Plates are designed to fit back to back with the side at most risk having concealed fixings. Secured by 6 x M5 post torx countersunk security screws (supplied as standard for added safety/security).

Construction

The W2900 series plate is constructed from a high quality 316 grade stainless steel sheet metal, a corrosion resistant stainless steel cam, an integrated precision ground 8mm stainless steel bush that provides enhanced handle support and strength, a spring steel wire torsion spring to eliminate handle sag and a heavy duty stainless steel stop cam. All levers, knobs and pulls are constructed from high quality 316

grade stainless steel (excluding the flush pull "FP" which is constructed from brass with a satin nickel plate finish).

Handing

Plates are handed.

Fire Rating

The 2900 Series wide plate furniture is fire rated and complies with Australian Standard AS1905-1-2005 Part 1.

FIRE RATED



Lever, Knob, Pull and Turn designs

Standard lever is No. 32S or No. 29 lever the knob is SPOKK (special orbit knurled knob). Flush Handles (FH) and D Pull (DP) offer features such as solid infill sections where anti-ligature features are required. All levers and knobs are spring assisted for positive operation. Other levers are available on request.

Patented clutching turn design

All turns on Kaba 2900 Series offer our unique patented clutching turn. This feature offers the ability to override with a key from the outside when the turn is being held from the opposite side of the door.

Door Thickness

Standard model is designed to suit 35mm-50mm thick door as standard. For thick doors extended screw packs are required.

Functions

See the function chart for all functions.

Finish

Satin Stainless Steel SSS

SPECIFICATION

The door furniture should be square in shape, 160mm (H) x 160mm (W) x 4mm (T), manufactured from stainless steel. The corners are to have a 2mm radius, stainless steel cams. The plate is to incorporate an 8mm bearing surface.

The screws are to be a countersunk stainless steel M5 post torx security screw type, visible only from the non-secure face of the door.

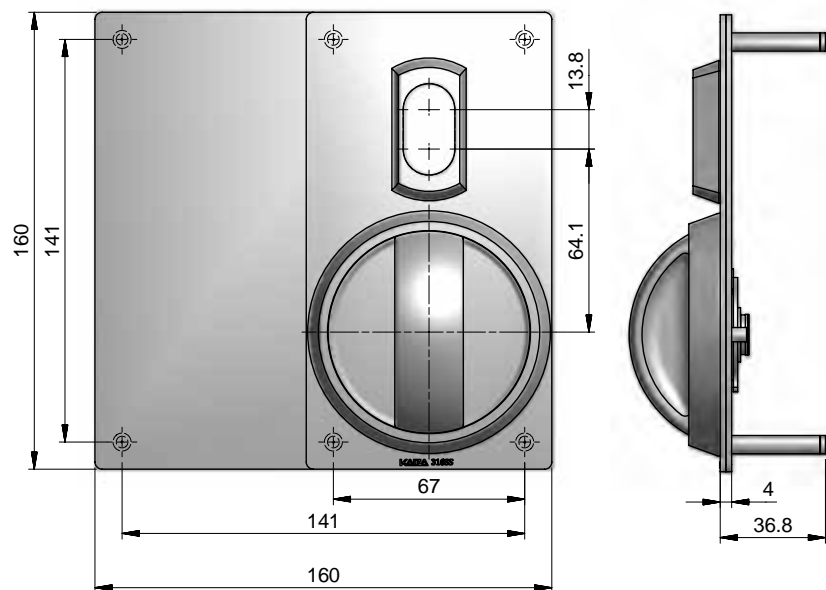

Wide Plate Range - Functions

Plates with Flush Handle

Note: Illustrations are shown as right hand, all plates that require handing are listed with ** in part number
MTO= Made to Order, these items are available as a special order

W2901 Function

Wide plate with cylinder hole guard and flush handle # specify cylinder guard

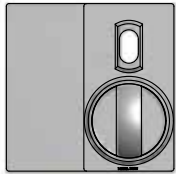

CONCEALED
W2901C-#-FHSSS**

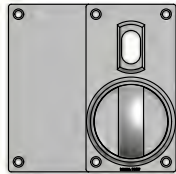

VISIBLE
W2901V-#-FHSSS**

W2902 Function

Wide plate with flush handle

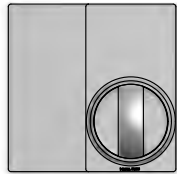

CONCEALED
W2902C-FHSSS**

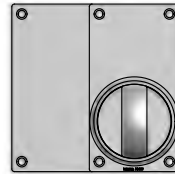

VISIBLE
W2902V-FHSSS**

W2913 Function

Wide plate with turn and flush handle

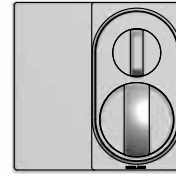

CONCEALED
W2913C-FHSSS**

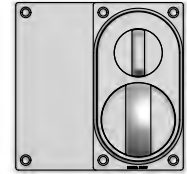

VISIBLE
W2913V-FHSSS**

W2953 Function

Wide plate with indicating slot and flush handle

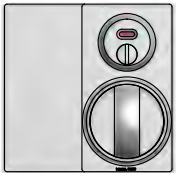

CONCEALED
W2953C-FHSSS**

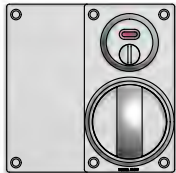

VISIBLE
W2953V-FHSSS**

W2963 Function

Wide plate with indicating turn and flush handle

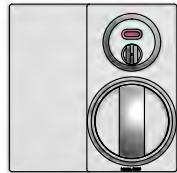

CONCEALED
W2963C-FHSSS**



VISIBLE
MTO

Plates without Handles

W2904 Function

Wide plate with cylinder hole guard #specify cylinder guard

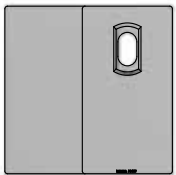

CONCEALED
W2904C-#-SSS**

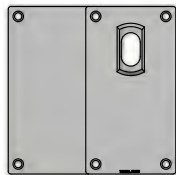

VISIBLE
W2904V-#-SSS**

W2905 Function

Wide plate

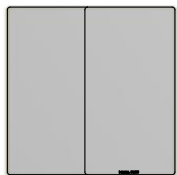

CONCEALED
W2905C-SSS**

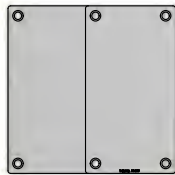

VISIBLE
W2905V-SSS**

W2906 Function

Wide plate with turn

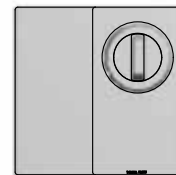

CONCEALED
W2906C-SSS**

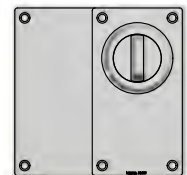

VISIBLE
W2906V-SSS**

W2923 Function

Wide plate with indicating slot



CONCEALED
W2923C-SSS**

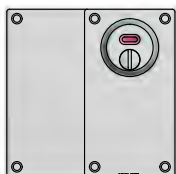

VISIBLE
W2923V-SSS**

W2933 Function

Wide plate with indicating turn

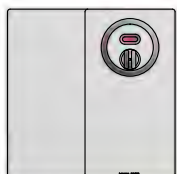

CONCEALED
W2933C-SSS**

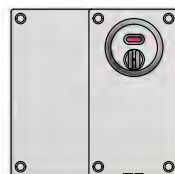

VISIBLE
W2933V-SSS**

Wide Plate Range - Functions

Plates with 29 Lever

Note: Illustrations are shown as right hand, all plates that require handing are listed with ** in part number
MTO= Made to Order, these items are available as a special order

W2901 Function

Wide plate with cylinder hole guard and 29 lever # specify cylinder guard

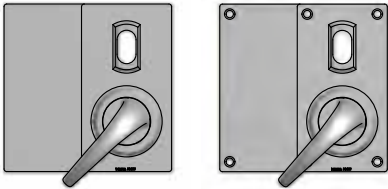

CONCEALED W2901C-#-29SSS**
VISIBLE W2901V-#-29SSS**

W2902 Function

Wide plate with 29 lever

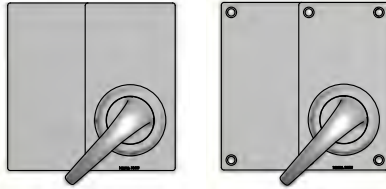

CONCEALED W2902C-29SSS**
VISIBLE W2902V-29SSS**

W2913 Function

Wide plate with turn and 29 lever

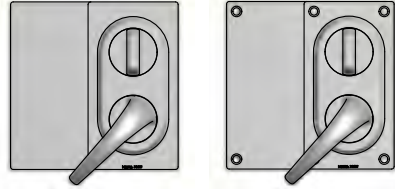

CONCEALED W2913C-29SSS**
VISIBLE W2913V-29SSS**

W2953 Function

Wide plate with indicating slot and 29 lever

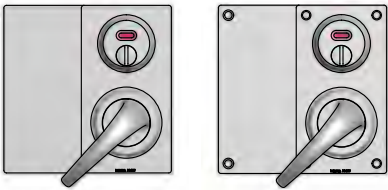

CONCEALED W2953C-29SSS**
VISIBLE W2953V-29SSS**

W2963 Function

Wide plate with indicating turn and 29 lever



CONCEALED W2963C-29SSS**
VISIBLE MTO

Plates with 32 Lever

W2901 Function

Wide plate with cylinder hole guard and 32 lever # specify cylinder guard

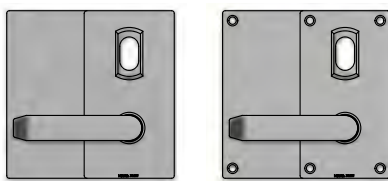

CONCEALED W2901C-#-32SSS**
VISIBLE W2901V-#-32SSS**

W2902 Function

Wide plate with 32 lever



CONCEALED W2902C-32SSS**
VISIBLE W2902V-32SSS**

W2913 Function

Wide plate with turn and 32 lever

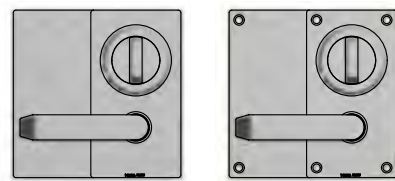

CONCEALED W2913C-32SSS**
VISIBLE W2913V-32SSS**

W2953 Function

Wide plate with indicating slot and 32 lever

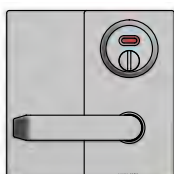

CONCEALED W2953C-32SSS**
VISIBLE MTO

W2963 Function

Wide plate with indicating turn and 32 lever

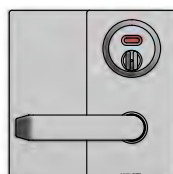

CONCEALED W2963C-32SSS**
VISIBLE MTO

Wide Plate Range - Functions

Plates with Knob

Note: Illustrations are shown as right hand, all plates that require handing are listed with ** in part number
MTO= Made to Order, these items are available as a special order

W2901 Function

Wide plate with cylinder hole guard and SPOKK # specify cylinder guard

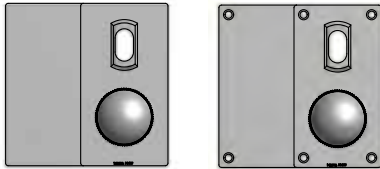

CONCEALED VISIBLE
W2901C-#-SPOKKSSS** W2901V-#-SPOKKSSS**

W2902 Function

Wide plate with SPOKK

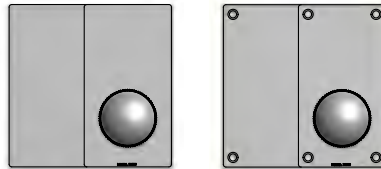

CONCEALED VISIBLE
W2902C-SPOKKSSS** W2902V-SPOKKSSS**

W2913 Function

Wide plate with turn and SPOKK

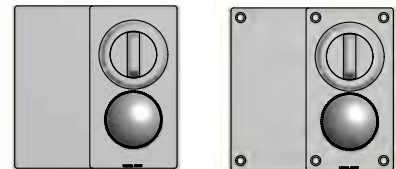

CONCEALED VISIBLE
W2913C-SPOKKSSS** W2913V-SPOKKSSS**

W2953 Function

Wide plate with indicating slot and SPOKK

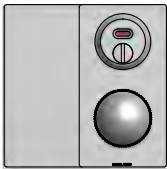

CONCEALED VISIBLE
W2953C-SPOKKSSS** MTO

W2963 Function

Wide plate with indicating turn and 29 lever

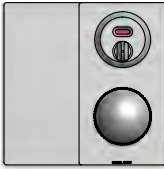

CONCEALED VISIBLE
W2963C-SPOKKSSS** MTO

Plates with D-Pull

W2901 Function

Wide plate with cylinder hole guard and D-Pull # specify cylinder guard

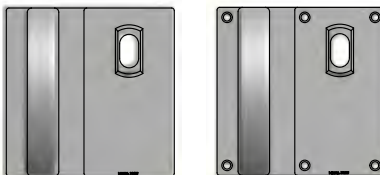

CONCEALED VISIBLE
W2901C-#-DPSSS** W2901V-#-DPSSS**

W2902 Function

Wide plate with D-Pull

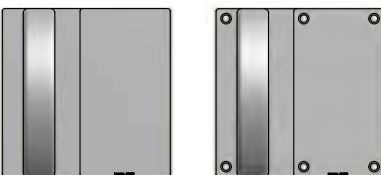

CONCEALED VISIBLE
W2902C-DPSSS** W2902V-DPSSS**

W2913 Function

Wide plate with turn and D-Pull

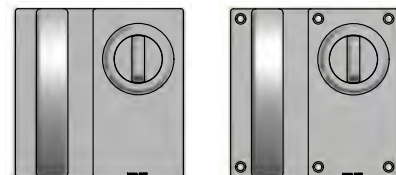

CONCEALED VISIBLE
W2913C-DPSSS** W2913V-DPSSS**

W2953 Function

Wide plate with indicating slot and D-Pull

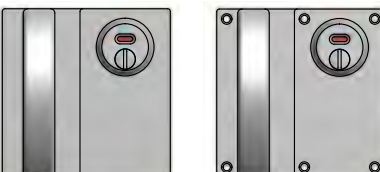

CONCEALED VISIBLE
W2953C-DPSSS** W2953V-DPSSS**

W2963 Function

Wide plate with indicating turn and D-Pull

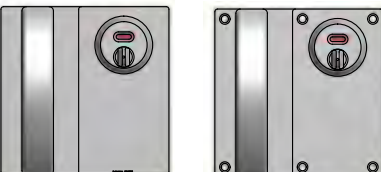

CONCEALED VISIBLE
W2963C-DPSSS** W2963V-DPSSS**

Wide Plate Range - Functions

Plates with Flush Pull

Note: Illustrations are shown as right hand, all plates that require handing are listed with ** in part number
MTO= Made to Order, these items are available as a special order

W2901 Function

Wide plate with cylinder hole guard and flush pull

specify cylinder guard

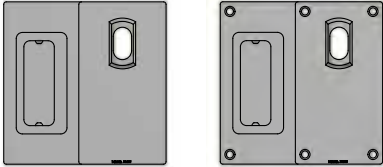

CONCEALED	VISIBLE
W2901C-#-FPSSS**	W2901V-#-FPSSS**

W2902 Function

Wide plate with flush pull

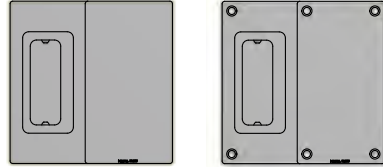

CONCEALED	VISIBLE
W2902C-FPSSS**	W2902V-FPSSS**

W2913 Function

Wide plate with turn and flush pull

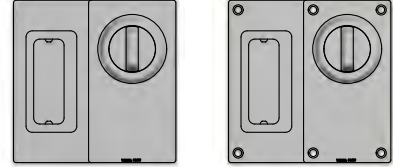

CONCEALED	VISIBLE
W2913C-FPSSS**	W2913V-FPSSS**

W2953 Function

Wide plate with indicating slot and flush pull

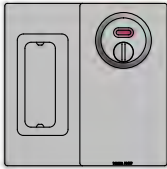

CONCEALED	VISIBLE
W2953C-FPSSS**	MTO

W2963 Function

Wide plate with indicating turn and flush pull



CONCEALED	VISIBLE
W2963C-FPSSS**	MTO



N2900 Series Plate Furniture - Narrow Plate

The N2900 Series has been manufactured for commercial applications where minimal ligature and impact points are required. The levers or knobs are mounted on a high quality 316 grade stainless steel sheet metal plate.



N2902V-29SSSL
Narrow - visible fix
29 Lever - left hand



N2902V-32SSSL
Narrow - visible fix
32 Lever - left hand



N2953C-FHSSS
Narrow - concealed
Indicating Slot &
Flush Handle



N2902V-SPOKKSSS
Narrow - visible
SPOKK knob



N2904CSSS
Narrow - concealed
cylinder hole guard

N2900 Series

Harm Minimisation Range - Narrow Plate

Dimensions

160mm (H), 86mm (W), 2mm (T).

Fixing

Plates are designed to fit back to back with the side at most risk having concealed fixings. Secured by 4 x M5 post torx countersunk security screws (supplied as standard for added safety/security).

Construction

The N2900 series plate is constructed from a high quality 316 grade stainless steel sheet metal, a corrosion resistant stainless steel cam, an integrated precision ground 8mm stainless steel bush that provides enhanced handle support and strength, a spring steel wire torsion spring to eliminate handle sag and a heavy duty stainless steel stop cam. All levers, knobs and pulls are constructed from high quality 316

grade stainless steel (excluding the flush pull "FP" which is constructed from brass with a satin nickel plate finish).

Handing

Plates are handed.

Fire Rating

The 2900 Series narrow plate furniture is fire rated and complies with Australian Standard AS1905-1-2005 Part 1.



Lever, Knob, Pull and Turn designs

Standard lever is No. 32S or No. 29 lever the knob is SPOKK (special orbit knurled knob). Flush Handles (FH) and D Pull (DP) offer features such as solid infill sections where anti-ligature features are required. All levers and knobs are spring assisted for positive operation. Other levers are available on request.

Patented clutching turn design

All turns on Kaba 2900 Series offer our unique patented clutching turn. This feature offers the ability to override with a key from the outside when the turn is being held from the opposite side of the door.

Door Thickness

Standard model is designed to suit 35mm-50mm thick door as standard. For thick doors extended screw packs are required.

Functions

See the function chart for all functions.

Finish

Satin Stainless Steel SSS

SPECIFICATION

The door furniture should be rectangular in shape, 160mm (H) x 86mm (W) x 2mm (T), manufactured from stainless steel. The corners are to have a 2mm radius, stainless steel cams. The plate is to incorporate an 8mm bearing surface.

The screws are to be a countersunk stainless steel M5 post torx security screw type, visible only from the non-secure face of the door

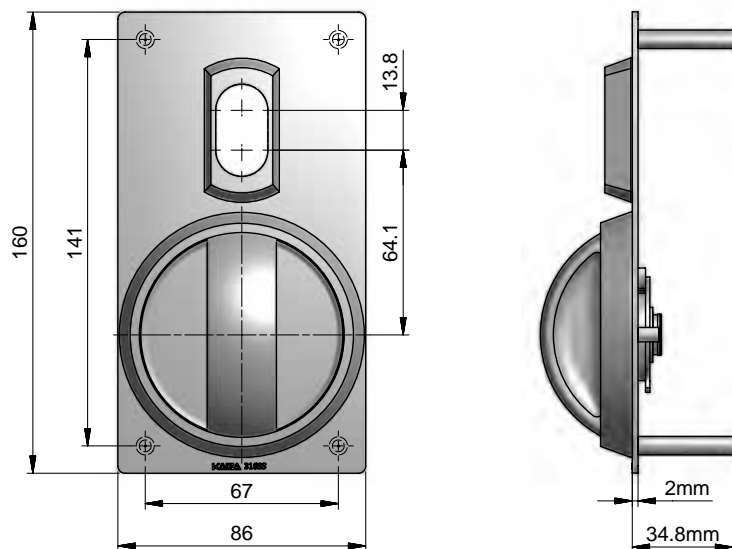

Narrow Plate Range - Functions

Plates with Flush Handle

Note: Illustrations are shown as right hand, all plates that require handing are listed with ** in part number
MTO= Made to Order, these items are available as a special order

N2901 Function

Narrow plate with cylinder hole guard and flush handle # specify cylinder guard

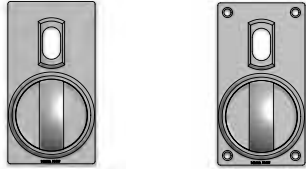

CONCEALED N2901C-#-FHSSS
VISIBLE N2901V-#-FHSSS

N2902 Function

Narrow plate with flush handle

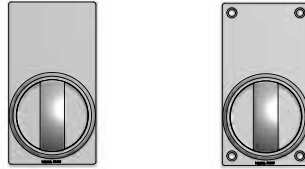

CONCEALED N2902C-FHSSS
VISIBLE N2902V-FHSSSS

N2913 Function

Narrow plate with turn and flush handle

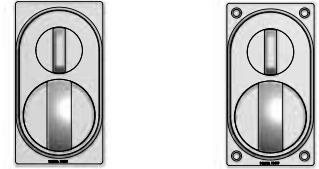

CONCEALED N2913C-FHSSS
VISIBLE N2913V-FHSSS

N2953 Function

Narrow plate with indicating slot and flush handle

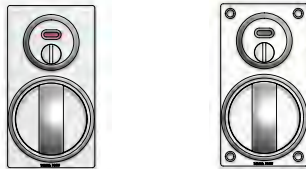

CONCEALED N2953C-FHSSS
VISIBLE N2953V-FHSSS

N2963 Function

Narrow plate with indicating turn and flush handle

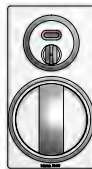

CONCEALED N2963C-FHSSS
VISIBLE MTO

Plates without Handles

N2904 Function

Narrow plate with cylinder hole guard # specify cylinder guard

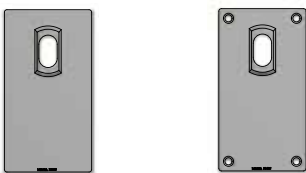

CONCEALED N2904C-#-SSS
VISIBLE N2904V-#-SSS

N2905 Function

Narrow plate

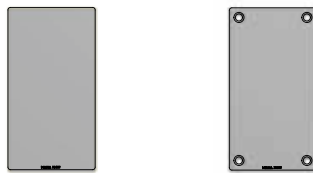

CONCEALED N2905C-SSS
VISIBLE N2905V-SSS

N2906 Function

Narrow plate with turn

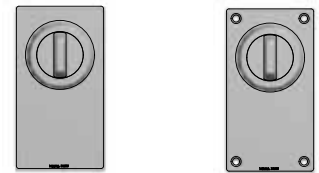

CONCEALED N2906C-SSS
VISIBLE N2906V-SSS

N2923 Function

Narrow plate with indicating slot

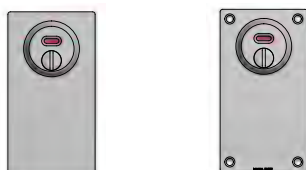

CONCEALED N2923C-SSS
VISIBLE N2923V-SSS

N2933 Function

Narrow plate with indicating turn

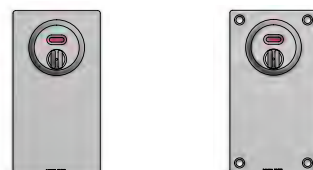

CONCEALED N2933C-SSS
VISIBLE N2933V-SSS

Narrow Plate Range - Functions

Plates with 29 Lever

Note: Illustrations are shown as right hand, all plates that require handing are listed with ** in part number
MTO= Made to Order, these items are available as a special order

N2901 Function

Narrow plate with cylinder hole guard and 29 lever # specify cylinder guard

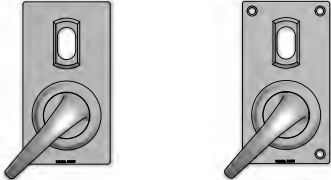

CONCEALED N2901C-#-29SSS**
VISIBLE N2901V-#-29SSS**

N2902 Function

Narrow plate with 29 lever

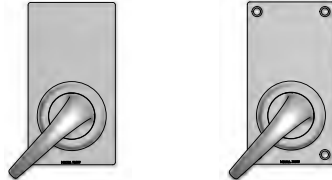

CONCEALED N2902C-29SSS**
VISIBLE N2902V-29SSSS**

N2913 Function

Narrow plate with turn and 29 lever

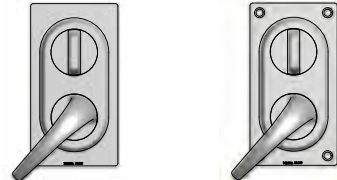

CONCEALED N2913C-29SSS**
VISIBLE N2913V-29SSS**

N2953 Function

Narrow plate with indicating slot and 29 lever

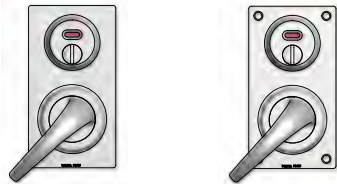

CONCEALED N2953C-29SSS**
VISIBLE N2953V-29SSS**

N2963 Function

Narrow plate with indicating turn and 29 lever



CONCEALED N2963C-29SSS**
VISIBLE MTO

Plates with 32 Lever

N2901 Function

Narrow plate with cylinder hole guard and 32 lever # specify cylinder guard

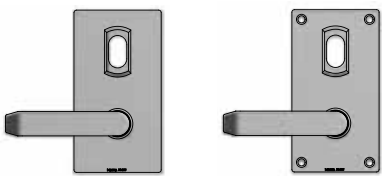

CONCEALED N2901C-#-32SSS**
VISIBLE N2901V-#-32SSS**

N2902 Function

Narrow plate with 32 lever

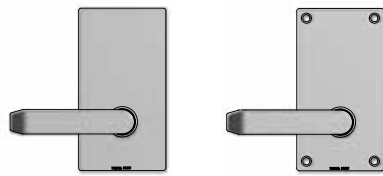

CONCEALED N2902C-32SSS**
VISIBLE N2902V-32SSSS**

N2913 Function

Narrow plate with turn and 32 lever

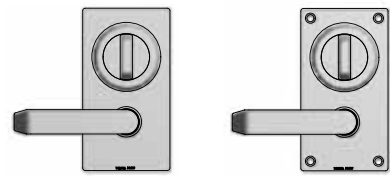

CONCEALED N2913C-32SSS**
VISIBLE N2913V-32SSS**

N2953 Function

Narrow plate with indicating slot and 32 lever



CONCEALED N2953C-32SSS**
VISIBLE MTO

N2963 Function

Narrow plate with indicating turn and 32 lever

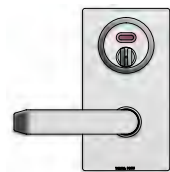

CONCEALED N2963C-32SSS**
VISIBLE MTO

Narrow Plate Range - Functions

Plates with Knob

Note: Illustrations are shown as right hand, all plates that require handing are listed with ** in part number
MTO= Made to Order, these items are available as a special order

N2901 Function

Narrow plate with cylinder hole guard and SPOKK # specify cylinder guard

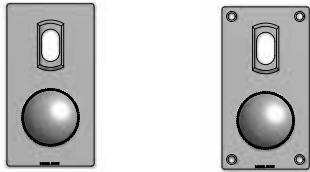

CONCEALED N2901C-#-SPOKKSSS**
VISIBLE N2901V-#-SPOKKSSS**

N2902 Function

Narrow plate with SPOKK

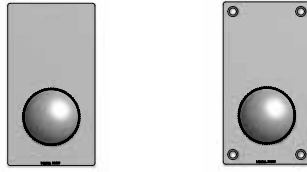

CONCEALED N2902C-SPOKKSSS**
VISIBLE N2902V-SPOKKSSS**

N2913 Function

Narrow plate with turn and SPOKK

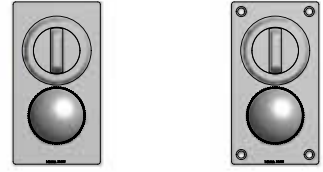

CONCEALED N2913C-SPOKKSSS**
VISIBLE N2913V-SPOKKSSS**

N2953 Function

Narrow plate with indicating slot and SPOKK

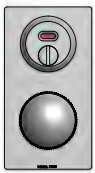

CONCEALED N2953C-SPOKKSSS**
VISIBLE MTO

N2963 Function

Narrow plate with indicating turn and SPOKK



CONCEALED N2963C-SPOKKSSS**
VISIBLE MTO

Plates with D-Pull

N2902 Function

Narrow plate with D-Pull

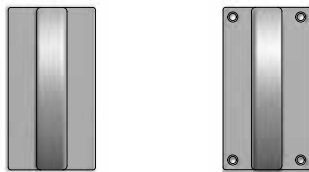

CONCEALED N2902C-DPSSS
VISIBLE N2902V-DPSSS

Plate Furniture

Notes
