

TRU-CLOSE HEAVY DUTY
HINGES ON PED GATE
1:4

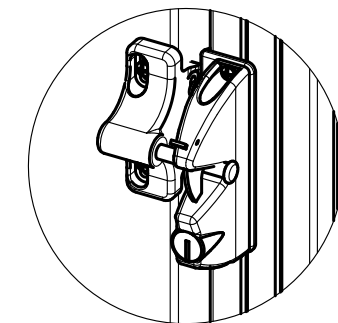

LOKKLATCH ON PED GATE
1:4

PANEL CODE	DESCRIPTION	BRACKET CODE	HEIGHT	WIDTH	PANEL RAKE	HORIZONTALS	VERTICALS	TUBE SPACINGS
SFP-1400G	STABIFENCE PANEL	N/A	1440	1810	N/A	STABIWOOD TGV	N/A	N/A
SFPGF/1412	STABIFENCE PEDESTRIAN GATE	N/A	1400	1200	N/A	STABIWOOD TGV	N/A	N/A



SIZE:	A3	SCALE:	1:25
DRAWING NO:	SF14 - SS	REVISION:	01
DATE ISSUED:	2023-04-20	SHEET:	1 OF 2

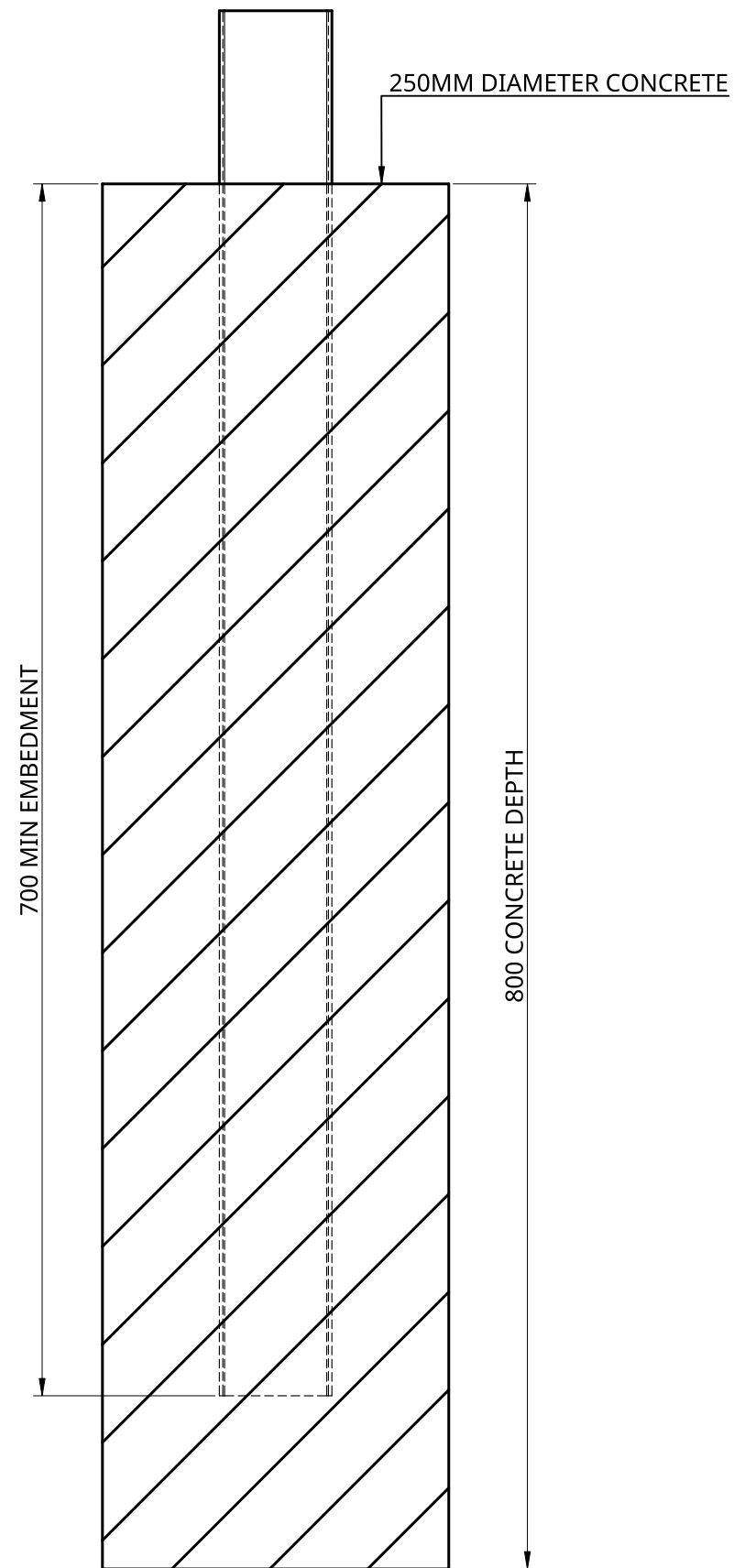

IN GROUND POST CONNECTION

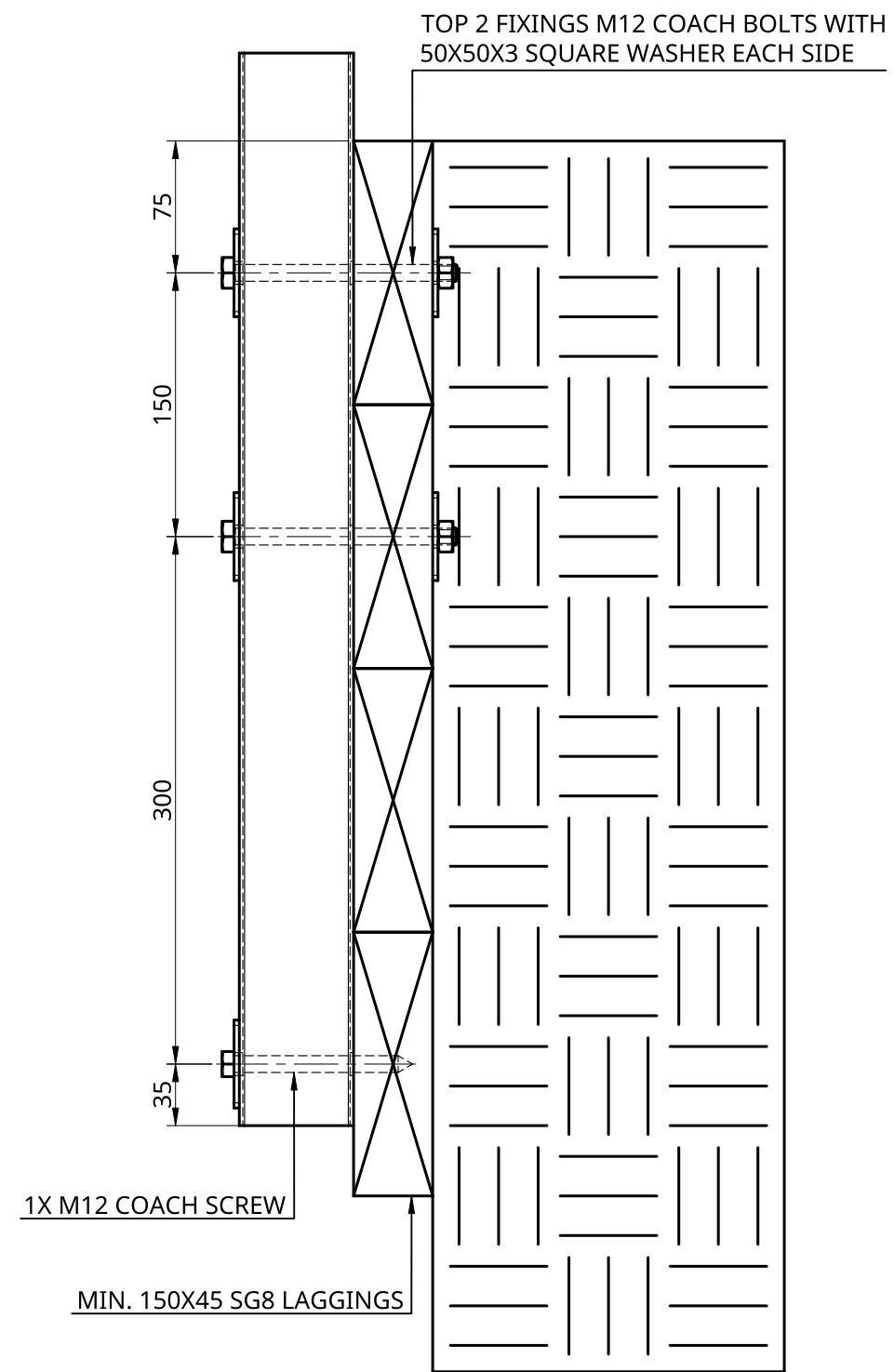

SIDE FIX TO TIMBER RETAINING WALL CONNECTION

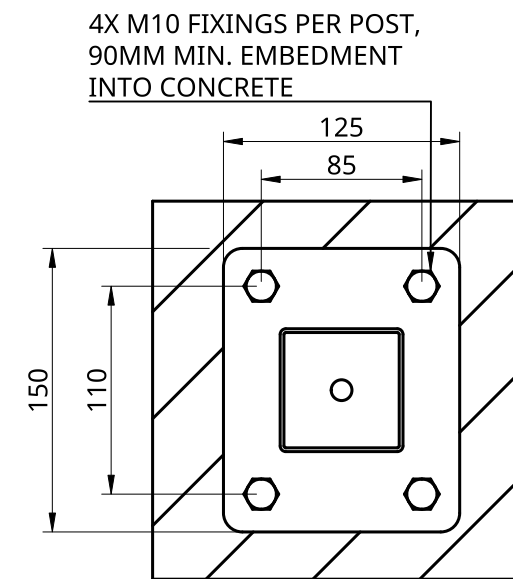

BASEPLATED POST CONNECTION

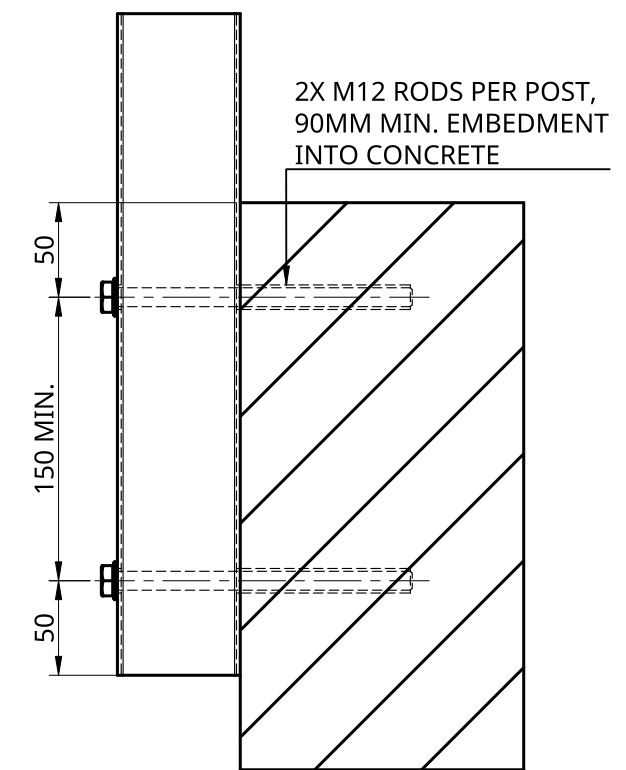

SIDE FIX TO CONCRETE CONNECTION



SIZE:	A3	SCALE:	1:4
DRAWING NO:	SF14 - SS	REVISION:	01
DATE ISSUED:	2023-04-20	SHEET:	2 OF 2