

TRU-CLOSE HEAVY DUTY
HINGES ON PED GATE
1:4

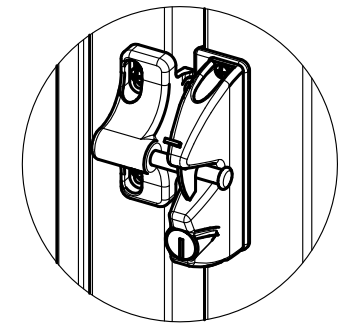

LOKKLATCH ON PED GATE
1:4

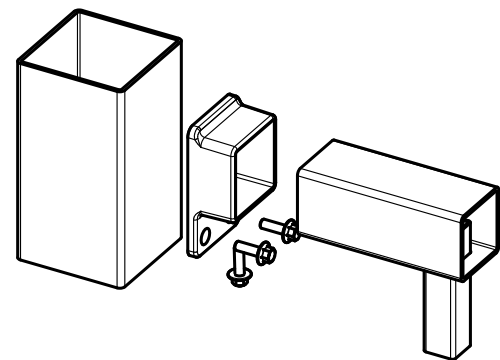

FIXED PANEL TO POST DETAIL
1:4

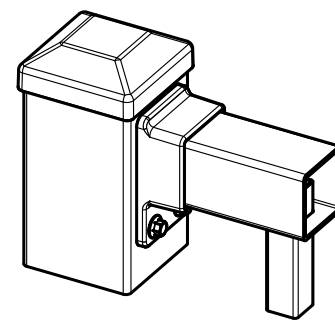

FIXED PANEL TO POST DETAIL
1:4

PANEL CODE	DESCRIPTION	BRACKET CODE	HEIGHT	WIDTH	PANEL RAKE	HORIZONTALS	VERTICALS	TUBE SPACINGS
UFFIN12	PALADIN FENCE PANEL	HBKT40	1200	2400	N/A	40X40X2 SHS	65X16X1.3 RHS	90 (106 CENTRES)
PPG/1210	PALADIN PEDESTRIAN GATE	N/A	1200	1000	N/A	40X40X2 SHS	65X16X1.3 RHS	90 (106 CENTRES)



SIZE:	A3	SCALE:	1:25
DRAWING NO:	PAL10 - SS	REVISION:	01
DATE ISSUED:	2023-04-20	SHEET:	1 OF 2

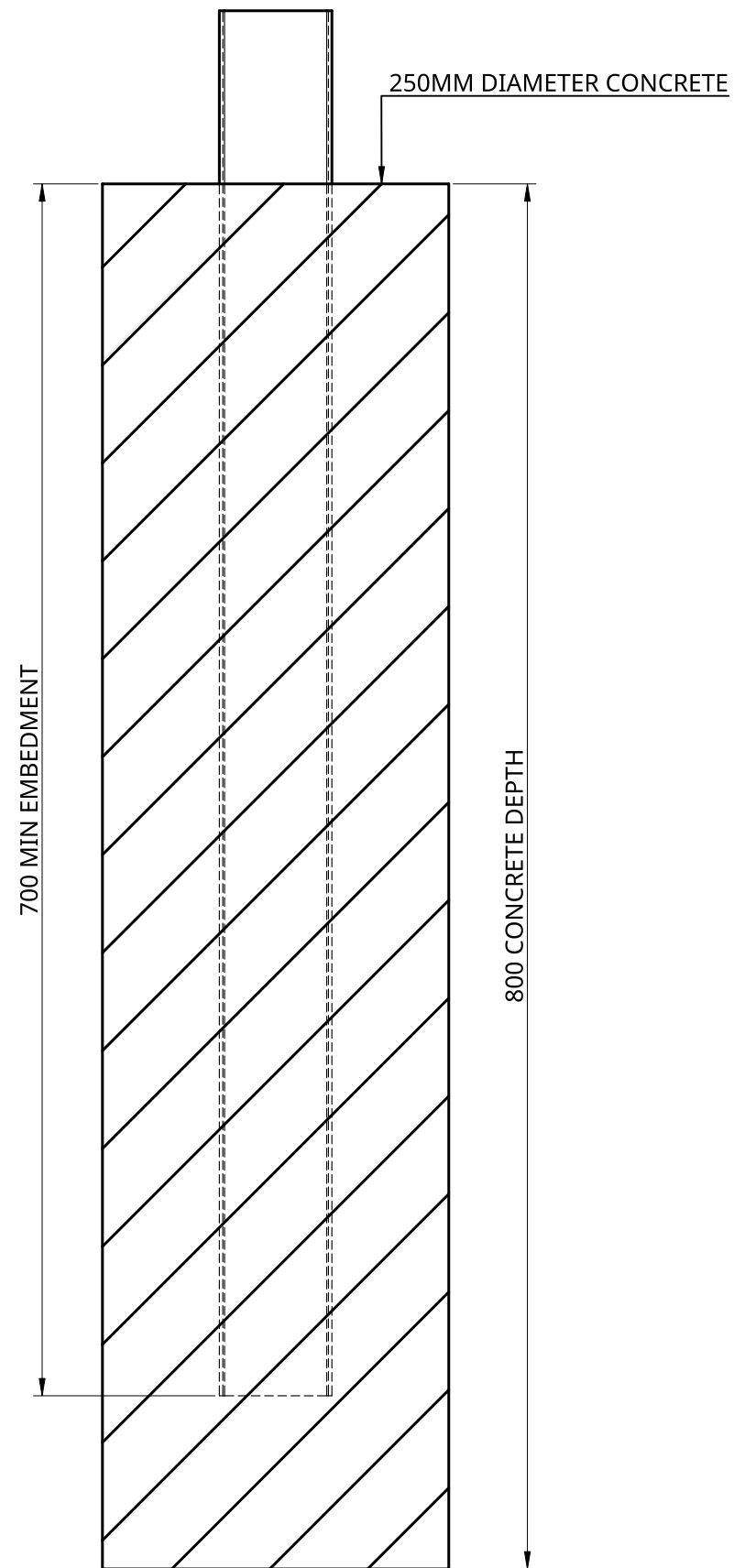

IN GROUND POST CONNECTION

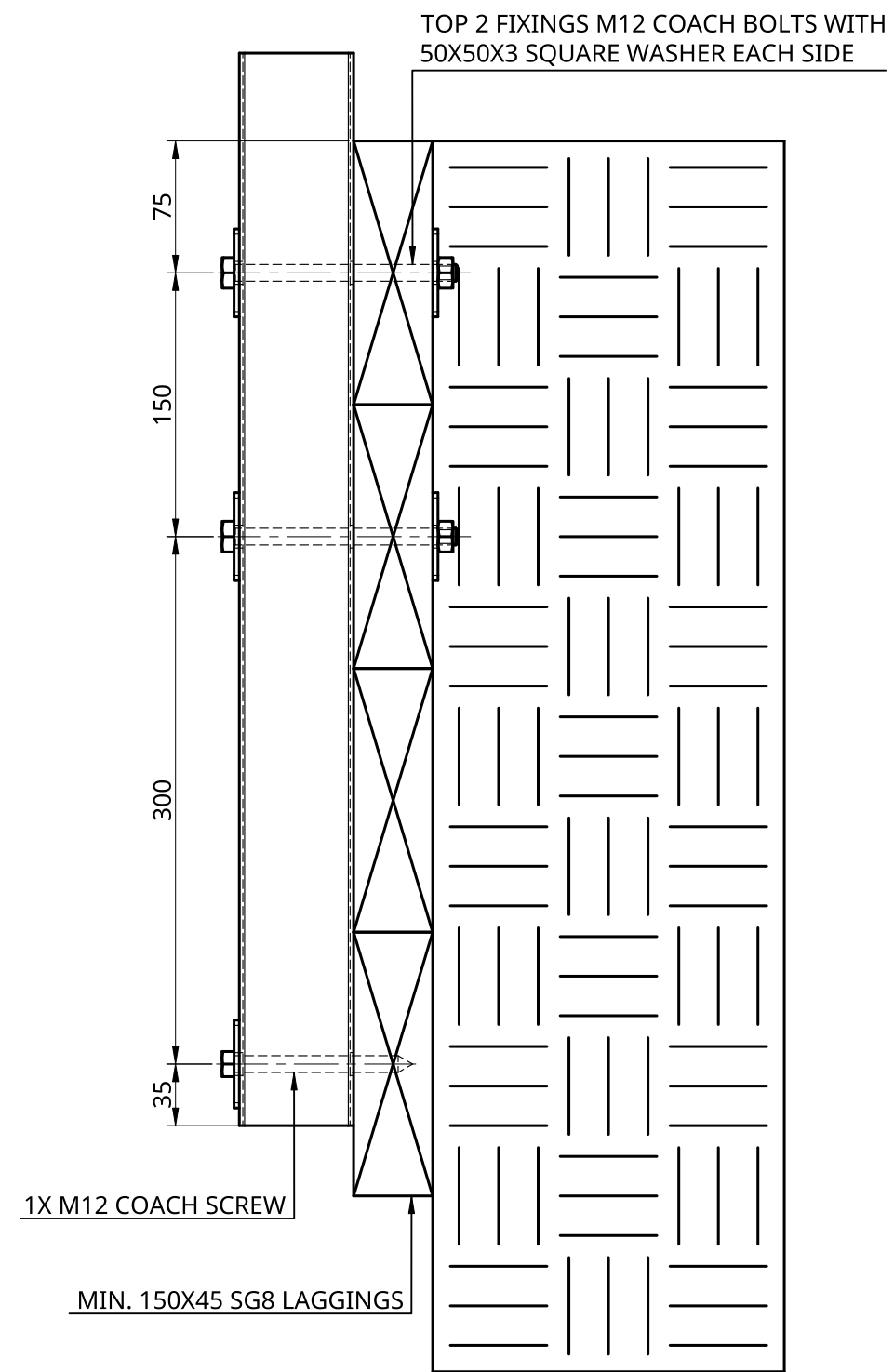

SIDE FIX TO TIMBER RETAINING WALL CONNECTION

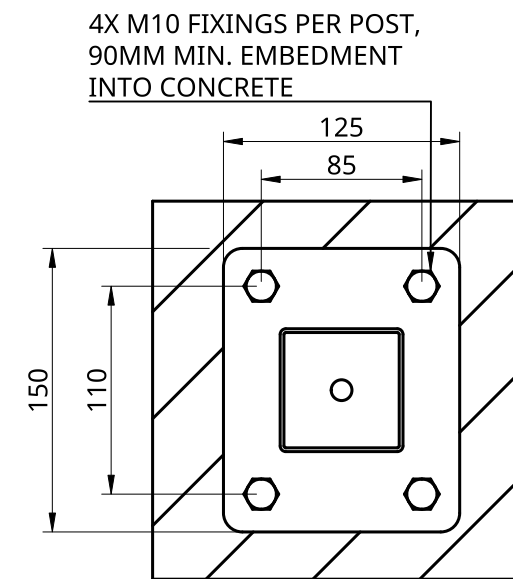

BASEPLATED POST CONNECTION

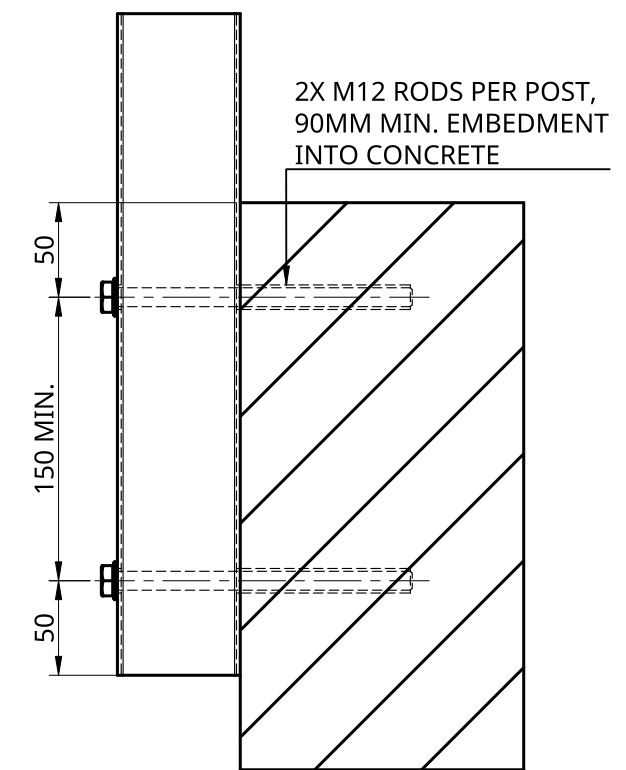

SIDE FIX TO CONCRETE CONNECTION



SIZE:	A3	SCALE:	1:4
DRAWING NO:	PAL10 - SS	REVISION:	01
DATE ISSUED:	2023-04-20	SHEET:	2 OF 2