

ECLIPSE SMART-HEAT™ ELECTRIC

Dim the lights and turn up the heat with our
Eclipse Smart-Heat™ Electric heater.

Available in six unique mounting options,
the new Bronic Eclipse Smart-Heat™ series adds style,
warmth and light to design-focused outdoor spaces.



ECLIPSE
SMART-HEAT™ ELECTRIC

SPECIFICATIONS

Reference the specification guide below to help you select the correct solution for your needs.

MODEL NUMBER

PRODUCT CODE	2620621-1
FUEL TYPE	ELECTRIC (3000W)
COLOUR	MATTE BLACK
MATERIAL (HEATER HEAD)	PREMIUM COATED 304 STAINLESS STEEL
MATERIAL (MOUNTING ARMS)	PREMIUM, DOUBLE COATED STEEL
HEAT AREA	11M ²
LED COLOUR	WARM WHITE - DIMMABLE
LED TEMPERATURE	3000K
LED LUMENS	216.6
RATED CURRENT & VOLTAGE	220-240 V - A.C. - 50-60 HZ
MINIMUM FLOOR CLEARANCE	CEILING 2438MM WALL 2438MM

MOUNTING OPTIONS

WALL MOUNT	2620636 (OPTIONAL)
200MM STRAIGHT CEILING MOUNT POLE	2620631 (OPTIONAL)
600MM STRAIGHT CEILING MOUNT POLE	2620632 (OPTIONAL)
600MM TWIN STRAIGHT CEILING MOUNT POLE	INCLUDED
600MM CURVED CEILING MOUNT POLE	2620634 (OPTIONAL)
1200MM STRAIGHT CEILING MOUNT POLE	2620635 (OPTIONAL)

CONTROL OPTIONS

DIMMER CONTROL	INCLUDED
MASTER REMOTE ECLIPSE*	2620662-1 (OPTIONAL)

*Control up to six zones of heaters with unlimited heaters per zone from a single remote. Dimmer control required.

Measurements displayed within this document are minimum requirements for installation. Bromic takes no responsibility for incorrect or non-compliant installations. All measurement in this document are displayed in mm.

DIMENSIONS

With a wide range of sizes available, find the ideal heater to suit your outdoor space.

PRODUCT MEASUREMENTS

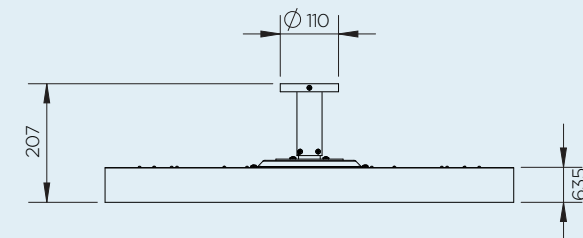
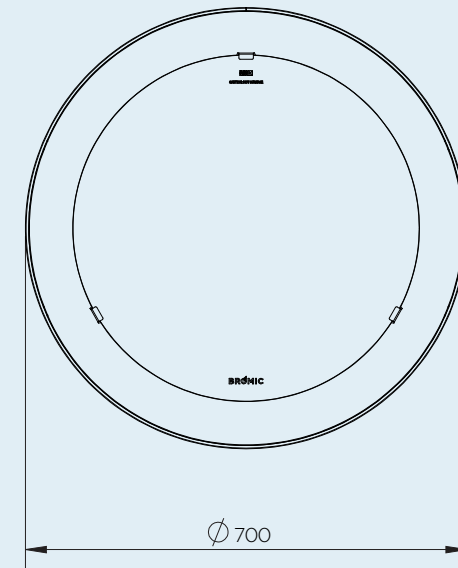

CLEARANCE

With a wide array of mounting options, Bromic offers solutions to compliment any décor and provide functionality for ambiance and comfort.

MOUNTING OPTIONS

CEILING MOUNTING OPTIONS

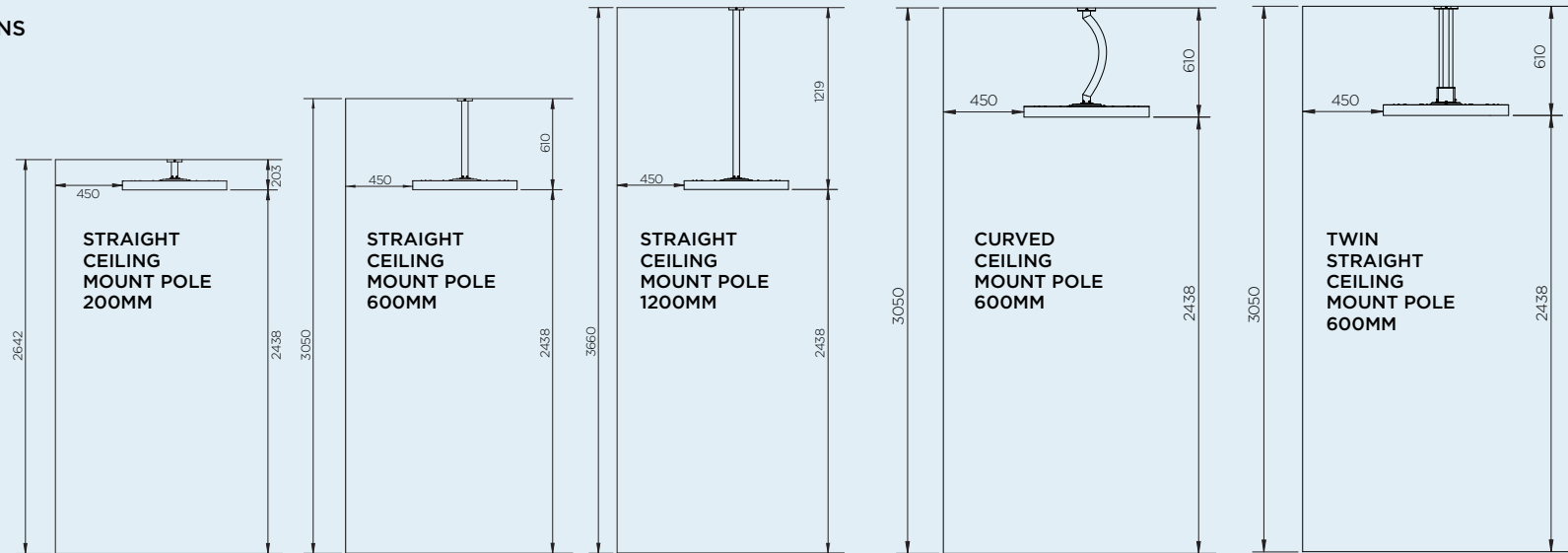

WALL MOUNTING

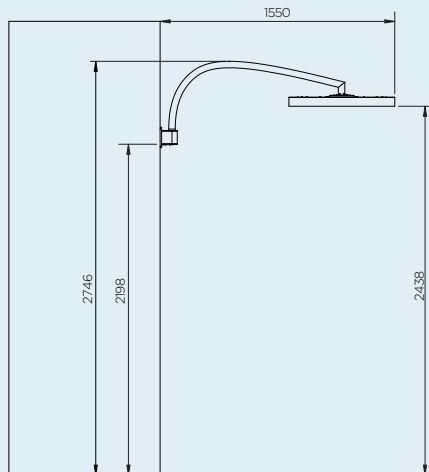

HEATING REACH

Creating ideal comfort levels, Bromic heaters offer a variety of heat distribution options to suit your outdoor heating needs.

HEAT AREAS

3000W SERIES

HEATING APPROXIMATELY 11M²
3000W HEATING POWER

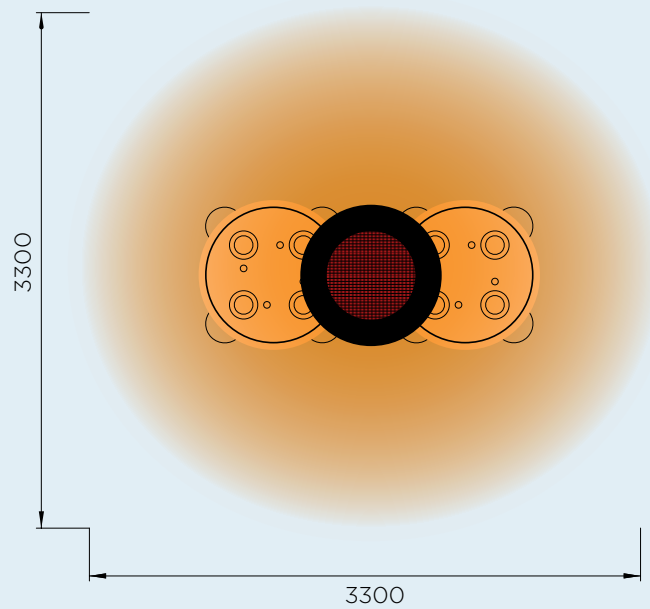

*HEAT AREA DEPENDENT ON AMBIENT TEMPERATURE AND WIND. OPTIMUM CONDITIONS EXPERIENCED AT APPROX 15.5°C AND IN A LOW WIND COVERED ENVIRONMENT.





EXTEND YOUR COMFORT OUTDOORS
WITH THE SUPERIOR HEAT AND
AWARD-WINNING DESIGN OF OUR
SMART-HEAT™ OUTDOOR HEATERS.

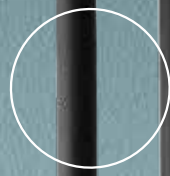

FLEXIBLE MOUNTING OPTIONS
 Minimal vertical clearance requirements and a wide range of wall, ceiling, and free-standing options to suit any space.

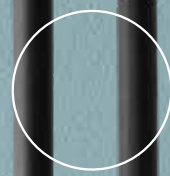

PREMIUM CONSTRUCTION
 Superior components, ensuring longevity of use and aesthetic appeal for years to come.

UNIQUE DESIGN
 Elegantly understated design that complements any design-focused outdoor environment.



CERAMIC SCREEN
 Spreads heat evenly across any area while minimising light emission from the heating element.



PRECISE CONTROL
 Accurately adjust the heat output (0/33/66/100%) for complete control over the level of comfort.



DIMMABLE LIGHT
 Complete flexibility over level of brightness for the right amount of ambience.



COMPATIBLE WITH SMART-WIRELESS TECHNOLOGY

BROMIC.COM

ASIA PACIFIC | NORTH AMERICA | EUROPE

Bromic pursues a policy of continuing improvement in design and performance of its products. The right is therefore reserved to vary specifications without notice.