

KOROK® SCISSOR STAIR SYSTEMS



OCTOBER 2024
Version 2

KOROK 

CONTENTS

INTRODUCTION	1	VERTICAL INSTALLATION - GENERAL DETAILS	20
Acoustic performance.....	1	Cutting panels	23
Fire performance	1	Last panel.....	23
100% reusable, minimum waste	1	Screw placement.....	24
Use only the current specification	2	Screw placement.....	25
Beware of substitutions	2	Table 1 - Screw placement vertical installation.....	25
Independently tested	2	Deflection C-track details.....	25
New Zealand Building Code (NZBC) compliance	2	Sealant placement.....	26
		Final check.....	27
SCOPE OF USE	3	HORIZONTAL INSTALLATION - GENERAL DETAILS	28
Design responsibility	3	Cutting panels	32
Design considerations	3	Last panel.....	33
Compliance.....	3	Screw placement.....	34
Compliance with the National Construction Code	3	Table 2 - Screw placement horizontal installation.....	34
Compliance with the New Zealand Building Code (NZBC), Clause C.....	3	Screw placement.....	35
Fire Resistance Ratings (FRR).....	3	C-track.....	35
Stair handrails.....	3	Deflection C-track details.....	35
Installation.....	3	Sealant placement.....	36
Liability	3	Final check.....	36
KOROK® SCISSOR STAIR SYSTEMS	4	KOROK® COMPONENTS SUMMARY	37
Figure 1 - Scissor stair tower	4	KOROK® PANEL PROPERTIES: 78MM	38
Figure 2 - Fire protection - two staircases separated by KOROK® scissor stair wall.....	5	Vertical span walls.....	38
Figure 3 - Quadrilateral section providing fire-resistance in the horizontal plane.....	6	Horizontal span walls	38
		Thermal resistance.....	38
KOROK® SCISSOR STAIR SYSTEMS	7	Definitions.....	38
Wall Type 1A (WT1A)	8	Use of tables	38
Wall Type 2 (WT2)	9	Deflection C-track details.....	38
Wall Type 2C (WT2C).....	10	Supporting structures.....	38
Wall Type 3C (WT3C).....	11	Installation note	38
Wall Type 3D (WT3D).....	12	Table 3 - Shear strength per fastener for the following connections.....	39
KOROK® SCISSOR STAIR SYSTEMS INSTALLATION	13	Table 4 - Horizontal span.....	39
INSTALLATION DETAILS SPECIFIC TO KOROK® SCISSOR STAIR SYSTEMS	14	Table 5 - Vertical span.....	39
Connecting to floor landings.....	16	KOROK® SCISSOR STAIR SYSTEMS DRAWINGS	40
Back-to-back C-track.....	17	SUSTAINABILITY	41
KOROK® scissor stair wall to stair stringer	18		
KOROK® landing bracket.....	19		

INTRODUCTION

SUPERIOR FIRE AND ACOUSTIC PERFORMANCE WITH CLIP-TOGETHER SIMPLICITY

- BRANZ tested
- Roll formed galvanised steel or colour steel outer shell
- Lightweight with an aerated concrete core
- Fire ratings up to -/240/240
- Acoustic ratings up to STC 76
- Panels interlock with clip-together simplicity for rapid installation
- Can be installed horizontally or vertically
- Non-combustible

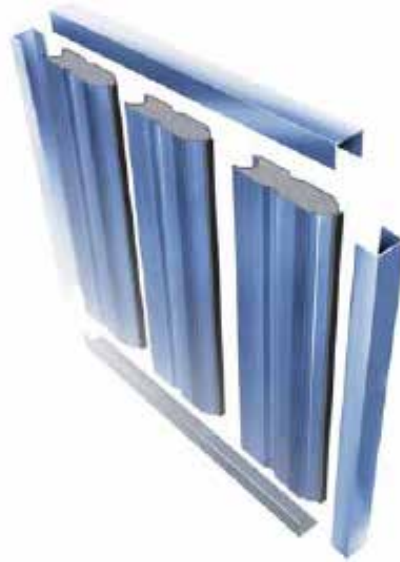

When acoustic and fire regulations demand a high performance, no-risk solution, KOROK® will exceed New Zealand Building Code requirements for internal and external non-load bearing walls simply and cost effectively.

Exceptionally strong yet lightweight, the interlocking panels can be easily erected by a small crew, making KOROK® much faster to install than conventional wall systems.

Construction using KOROK® allows a building to be made weather resistant much earlier in the construction cycle allowing internal work and finishing to be started sooner.

ACOUSTIC PERFORMANCE

KOROK®'s inherent mass and interlocking design gives it outstanding acoustic reduction properties making it highly suitable in buildings where acoustic performance is critical, such as cinemas, lecture theatres, apartments, recording studios and industrial/commercial intertenancy situations.

The unique interlocking design eliminates the risk of sound "leaks" between panels, and makes installation faster and simpler.

FIRE PERFORMANCE

KOROK® delivers proven two-way fire resistance over a long period of time. KOROK® has been tested and appraised by the Building Research Association of New Zealand (BRANZ).

100% REUSABLE, MINIMUM WASTE

KOROK® is manufactured in New Zealand and offers unique benefits in terms of sustainability and environmental performance:

- The raw components (steel and concrete) are 100% recyclable.
- Panels are custom manufactured to size, minimising waste at the factory and on the construction site.
- DECLARE - KOROK® has Declare Certification for our panels, the most accessed sustainability certification in the building industry <https://declare.living-future.org/products/korok-panel>.

INTRODUCTION

USE ONLY THE CURRENT SPECIFICATION

This publication may be superseded by a new publication. KOROK® Building Systems NZ Ltd accepts no liability for reliance upon publications that have been superseded. If you are unsure whether this is the current publication, visit www.korok.com or call 0800 773 777.

BEWARE OF SUBSTITUTIONS

All KOROK® Scissor Stair Systems have been designed and tested to ensure they are suitable for New Zealand conditions and provide specific resistance to fire and acoustic transmission.

As such, only tested KOROK® panels and components can be used in the construction of each KOROK® Scissor Stair System, ensuring that the finished wall will meet its performance specification.

INDEPENDENTLY TESTED

The FRRs of specifications published in this document have been obtained by independent testing or assessment sourced from organisations with accredited quality assurance. It is of prime importance to comply with the details of design, construction, and workmanship in this document.

NEW ZEALAND BUILDING CODE (NZBC) COMPLIANCE

The NZBC sets out both the legal minimum sound transmission between tenancies (Clause G6) and minimum levels of fire resistance (Clauses C3 and C6). The KOROK® Scissor Stair Systems Manual provides guidance on the specification and construction of systems that will both meet and exceed those minimum levels.

NZBC Clause B1 – Structure

The KOROK® Scissor Stair Systems meet the requirements for loads arising from self-weight, earthquake, wind, impact and creep and shrinkage.

NZBC Clause B2 – Durability

Under normal conditions of dry internal use, KOROK® Scissor Stair Systems have a serviceable life in excess of 50 years and satisfy the requirements of NZBC Clause B2 – Durability.

NZBC Clause C3 - Fire affecting areas beyond the source

KOROK® Scissor Stair Systems can be used to provide passive fire protection in accordance with the requirements of NZBC Clause 3 – Spread of Fire.

NZBC Clause C6 - Structural Stability

Compliance with (NZBC) Clause C6 'Structural Stability'.

In order to satisfy the requirements of the New Zealand Building Code (Clause C6) relating to "structural stability" designers must ensure that KOROK® elements are supported by primary elements that have at least the same fire rating as the KOROK® Scissor Stair System that is used.

Where the primary elements supporting the KOROK® Scissor Stair System are outside the fire cell, there is no requirement to apply the same FRR as the KOROK® Scissor Stair System. Notwithstanding, post fire stability requirements of the NZBC must also be satisfied.

NZBC Clause F2 - Hazardous Building Materials

KOROK® Scissor Stair Systems meet this requirement and will not present a health hazard to people.

NZBC Clause G6 – Airborne and Impact Sound

KOROK® Scissor Stair Systems, both meet and exceed the minimum requirements outlined in NZBC Clause G6. Consideration must be given to both the minimum requirements and the comfort of occupants.

SCOPE OF USE

The KOROK® Scissor Stair Systems detailed in this technical literature should cover most common situations where fire resistance is required.

KOROK® Scissor Stair Systems are walls constructed from 78mm thick, horizontally and/or vertically oriented KOROK® panels installed between two independent stair stringers in scissor stair configurations.

KOROK® wall systems are self-supporting non-load bearing walls that may be constructed with horizontally or vertically stacked panels, or a combination of both.

DESIGN RESPONSIBILITY

Responsibility for the design and detailing of the building incorporating KOROK® Scissor Stair Systems lies with the building owner and the parties that they engage for design services. The designers for the building must ensure that all details in the drawings and specification that relate to the KOROK® Scissor Stair Systems are relevant to the intended application. They must also ensure that additional information is provided for any aspects of construction that fall outside the scope and specifications of this manual, or that incorporate specific design requirements.

DESIGN CONSIDERATIONS

Designers are responsible for the design of buildings.

The construction details described in this publication, provide builders, engineers, designers, and architects a quick reference for assessing, designing, and installing KOROK® Scissor Stair Systems that directly attach to the structure.

Dead and live loads can cause significant deflection in some structures. Design and detailing of the KOROK® Scissor Stair Systems must take into account movement of the stair core structure that may affect the installation and performance of the KOROK® Scissor Stair Systems.

The supporting structural steel and concrete members are designed appropriately by a professional structural engineer by considering all the possible design actions. Design of structural steel and concrete members is not part of the scope of this manual.

The support construction above and below the wall must be capable of providing adequate vertical and lateral support for at least 120 minutes.

The actual structural strength of the stairs and the surrounding walls, which may not be KOROK® walls, and their ability to handle the design loads must be validated by a professional structural engineer engaged by others or by the relevant building project construction managers and are not part of this manual.

The supporting structure must be of the same or greater fire rating than that of the KOROK® Scissor Stair Systems.

COMPLIANCE

KOROK® Scissor Stair Systems comply with the requirements of the relevant National Construction Code (NCC) Australia and New Zealand Building Code (NZBC),

Part C, to support the use of the material, product, form of construction or design within the scope of this manual.

COMPLIANCE WITH THE NATIONAL CONSTRUCTION CODE

KOROK® Scissor Stair Systems comply with the requirements of the NCC 2022 under A5G3 (1) (d) deemed to satisfy (DTS) provisions of the NCC under A5G5 for fire resistance levels of wall systems in this manual based on Specifications 1 and 2 for fire resistance for building elements.

COMPLIANCE WITH THE NEW ZEALAND BUILDING CODE (NZBC), CLAUSE C

KOROK® Scissor Stair Systems comply with the requirements of relevant clauses of the New Zealand Building Code (NZBC), Clause C. KOROK® Scissor Stair Systems comply with the requirements that meets the normative requirements for demonstrating fire resistance performance as stated in the New Zealand acceptable solutions.

FIRE RESISTANCE RATINGS (FRR)

KOROK® Scissor Stair Systems provide fire resistance ratings (FRR) up to -/120/120 dependent on the span of the KOROK® panels and components selection described in the KOROK® Scissor Stair Systems wall type tables.

The FRR in the horizontal direction is provided (when the KOROK® Scissor Stair System is exposed to fire from one side) by the quadrilateral fire resistant section between the two independent stairs.

The FRR in the vertical direction is provided by the wall to stair stringer angle at the boundaries highlighted.

See "Figure 3 - Quadrilateral section providing fire-resistance in the horizontal plane" on page 6.

STAIR HANDRAILS

Handrails must be designed by a professional engineer.

For a maximum floor to floor height of 4.0 metres for Building Occupancy type A, type B and type 3C, handrails may be directly attached to the KOROK® Scissor Stair walls. For Building Occupancy type 1C and 2C, handrails must be attached to the building structure.

INSTALLATION

Refer to the "Installation Details Specific to KOROK® Scissor Stair Systems" on page 14 of this manual and to the drawing details on the KOROK® website <https://korok.com/systems/korok-scissor-stairs-solutions/>

LIABILITY

KOROK® Building Systems NZ Ltd accepts no liability if the KOROK® Scissor Stair Systems are not designed and installed in strict accordance with instructions contained in this manual, or any other technical information associated with the design of the systems.

KOROK® SCISSOR STAIR SYSTEMS

FIGURE 1 - SCISSOR STAIR TOWER

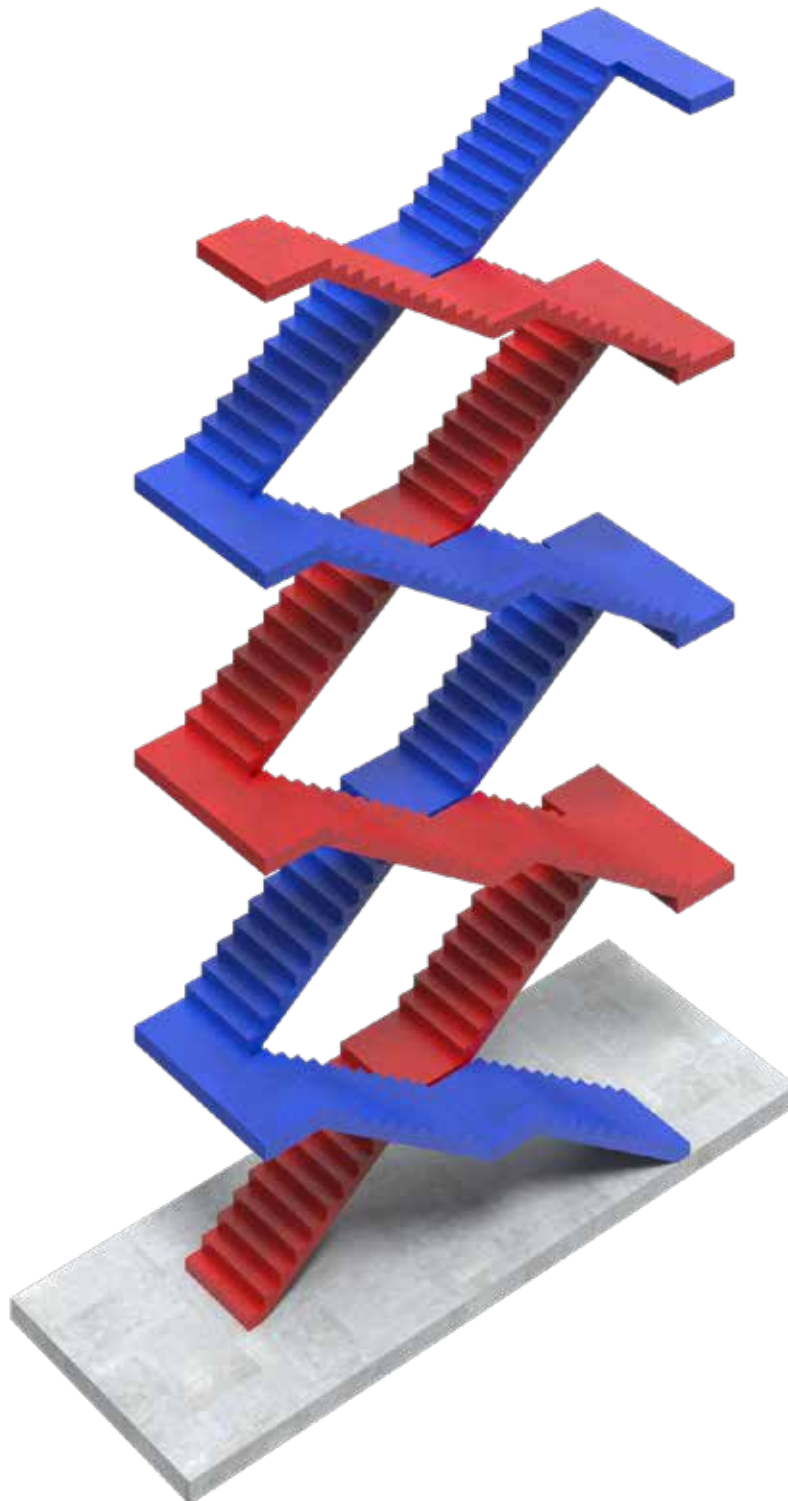

KOROK® SCISSOR STAIR SYSTEMS

FIGURE 2 - FIRE PROTECTION - TWO STAIRCASES SEPARATED BY KOROK® SCISSOR STAIR WALL

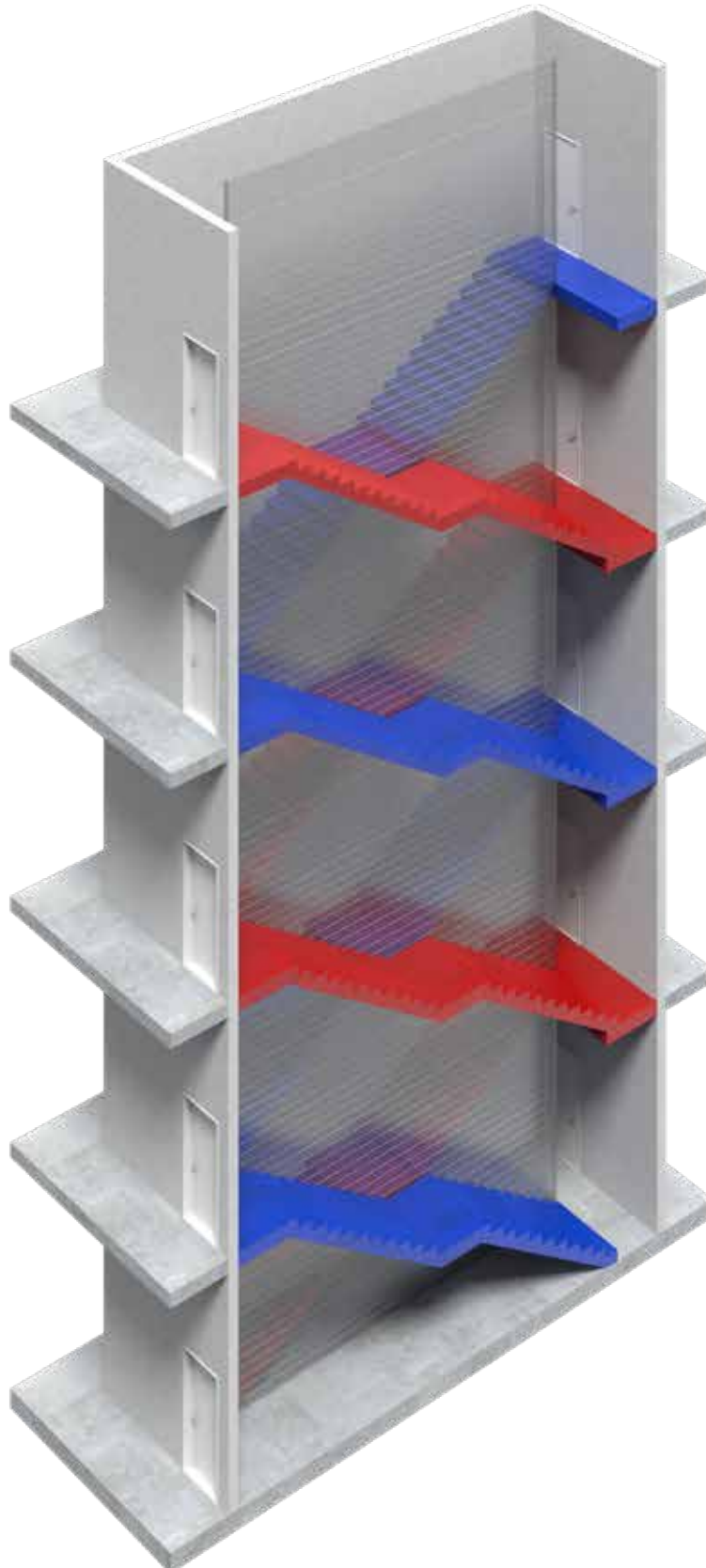

KOROK® SCISSOR STAIR SYSTEMS

FIGURE 3 - QUADRILATERAL SECTION PROVIDING FIRE-RESISTANCE IN THE HORIZONTAL PLANE

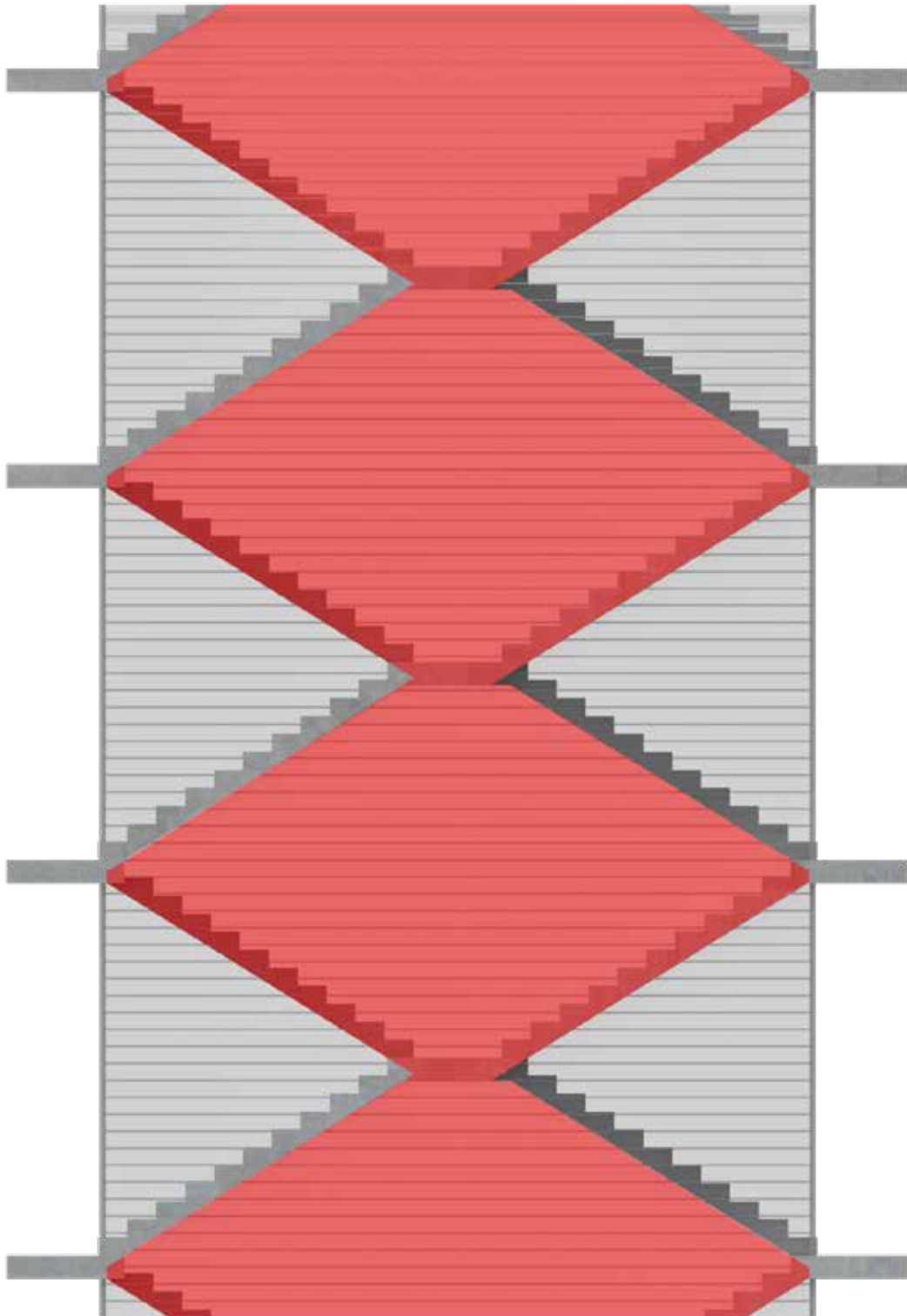



KOROK® SCISSOR STAIR SYSTEMS



KOROK® SCISSOR STAIR SYSTEMS

WALL TYPE 1A (WT1A)

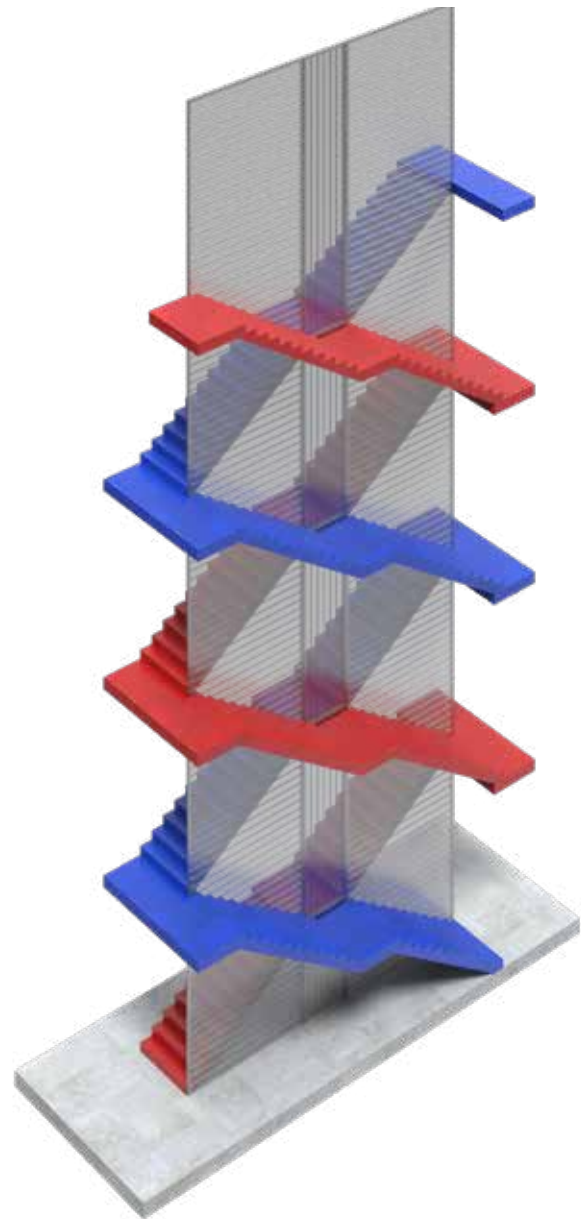
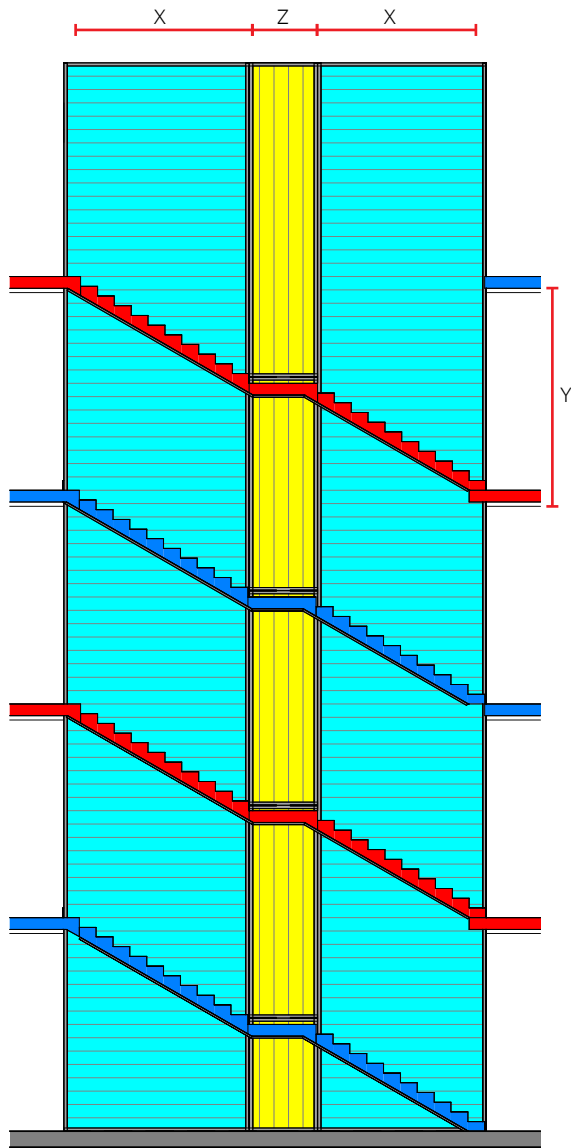

FRR -/60/60

C-TRACK BMT (MM)	X MAX (MM)	Y MAX (MM)	Z MIN (MM)	STAIR ANGLE BMT (MM) 0-80MM GAP
1.15	5500	4000	500	1.45

FRR -/120/120

C-TRACK BMT (MM)	X MAX (MM)	Y MAX (MM)	Z MIN (MM)	STAIR ANGLE BMT (MM) 0-80MM GAP
1.45	5000	4000	500	1.45

Notes:

The back-to-back C-tracks must be protected by a 0.7 BMT KOROK® KIT Flashing on one side.

Where the mid-landing is discontinuous, a KOROK® Landing Bracket is used to support the vertical back-to-back C-track.

KOROK® SCISSOR STAIR SYSTEMS

WALL TYPE 2 (WT2)

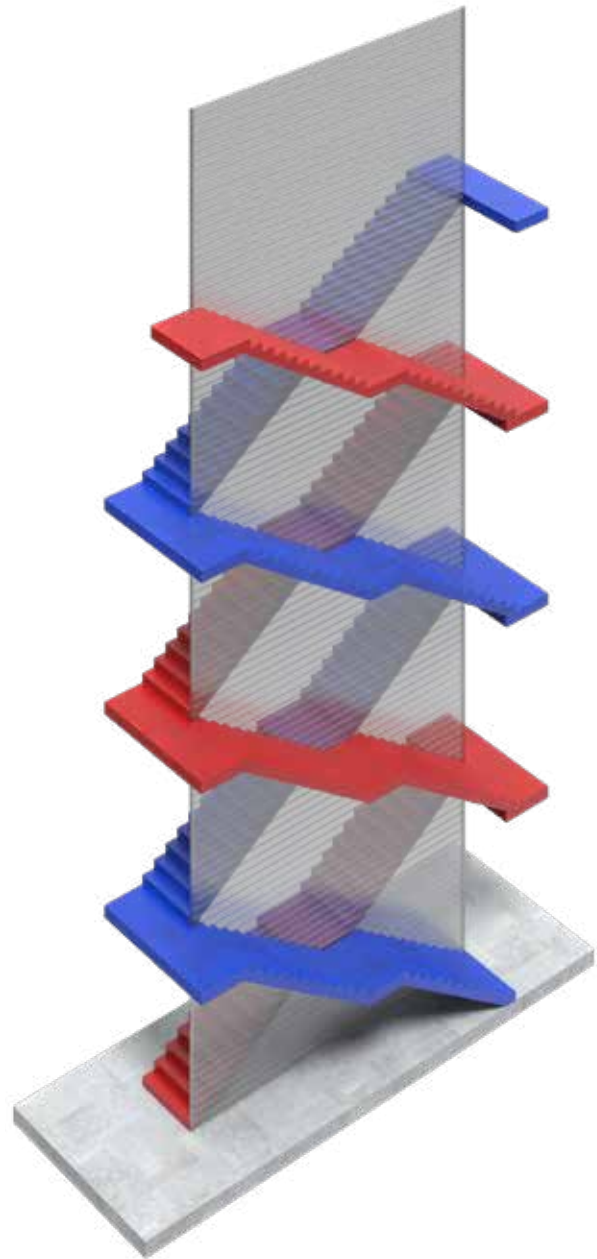
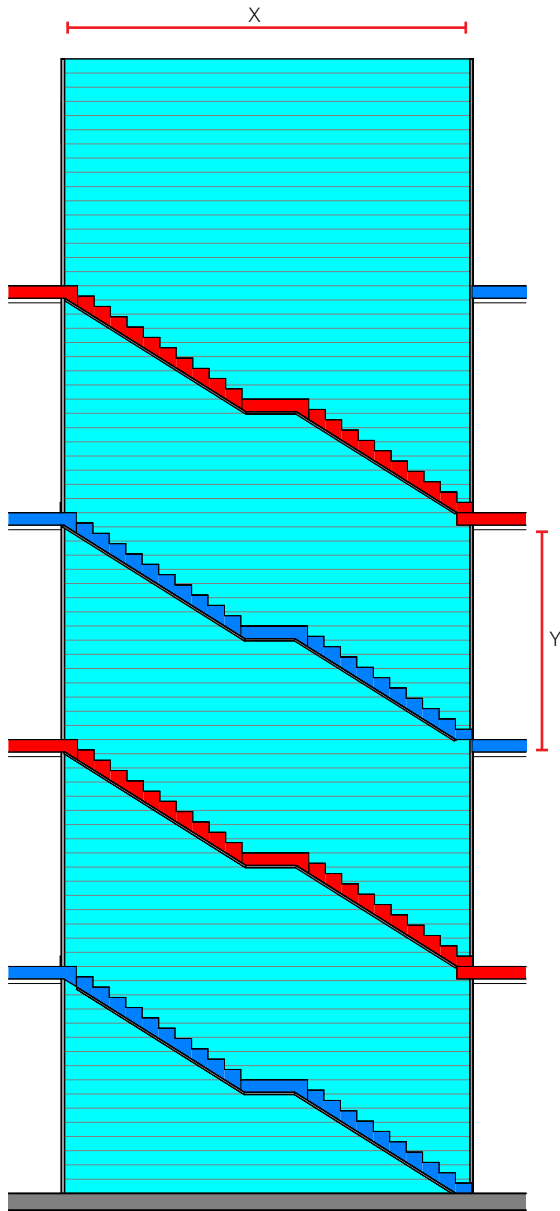

FRR -/60/60

C-TRACK BMT (MM)	X MAX (MM)	Y MAX (MM)	STAIR ANGLE BMT (MM) 0-80MM GAP
1.15	5500	4000	1.45

FRR -/120/120

C-TRACK BMT (MM)	X MAX (MM)	Y MAX (MM)	STAIR ANGLE BMT (MM) 0-80MM GAP
1.45	5000	4000	1.45

KOROK® SCISSOR STAIR SYSTEMS

WALL TYPE 2C (WT2C)

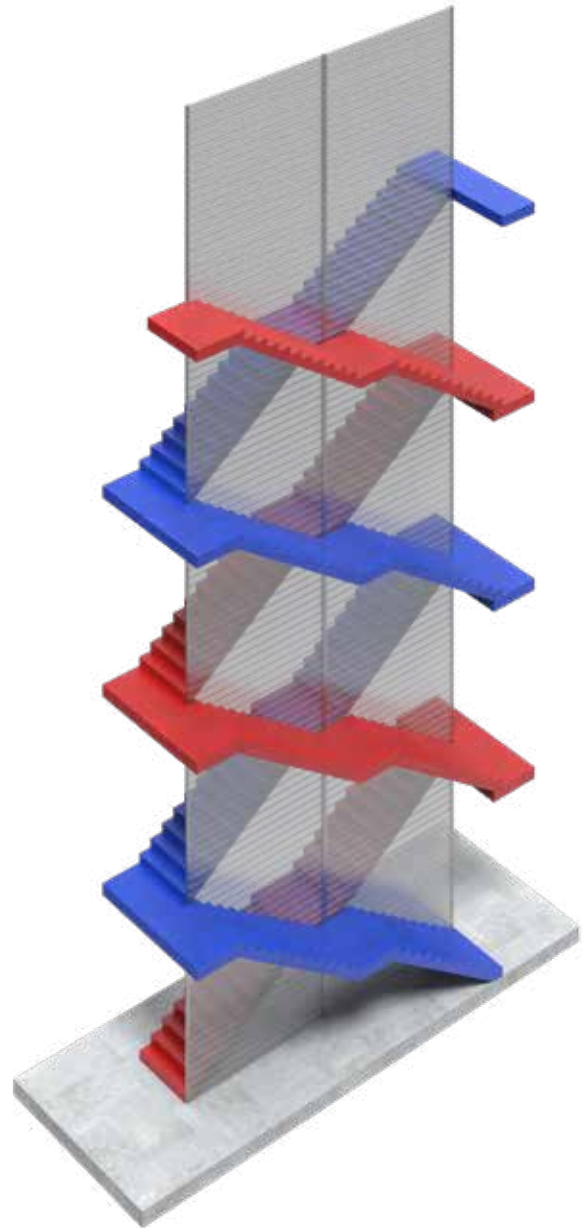
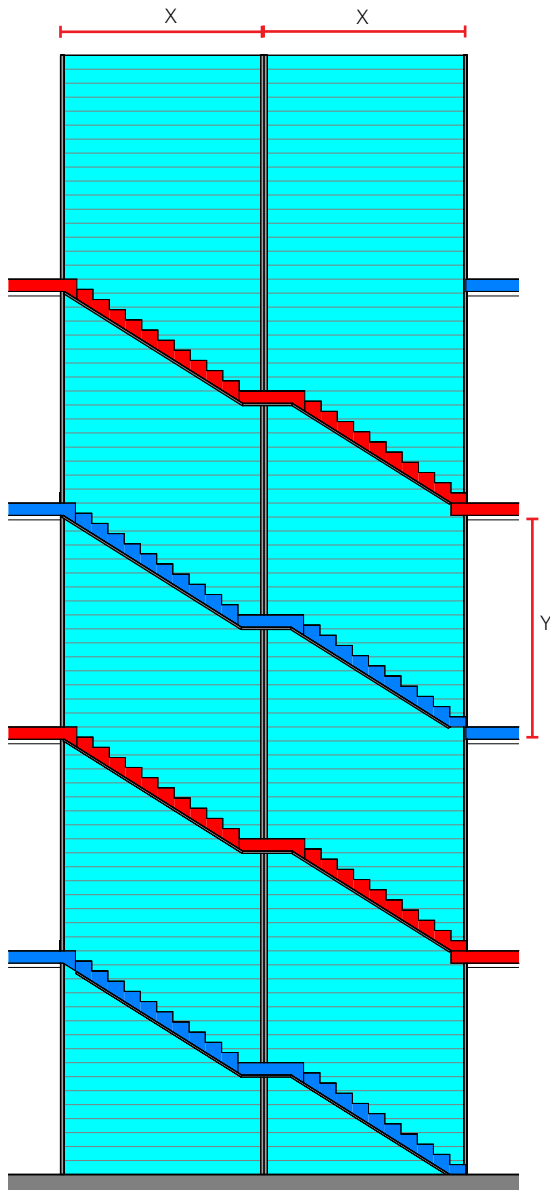

FRR -/60/60

C-TRACK BMT (MM)	X MAX (MM)	Y MAX (MM)	STAIR ANGLE BMT (MM) 0-80MM GAP
1.15	5500	4000	1.45

FRR -/120/120

C-TRACK BMT (MM)	X MAX (MM)	Y MAX (MM)	STAIR ANGLE BMT (MM) 0-80MM GAP
1.45	5000	4000	1.45

Notes:

The back-to-back C-tracks must be protected by a 0.7 BMT KOROK® KIT Flashing on one side.

Where the mid-landing is discontinuous, a KOROK® Landing Bracket is used to support the vertical back-to-back C-track.

KOROK® SCISSOR STAIR SYSTEMS

WALL TYPE 3C (WT3C)

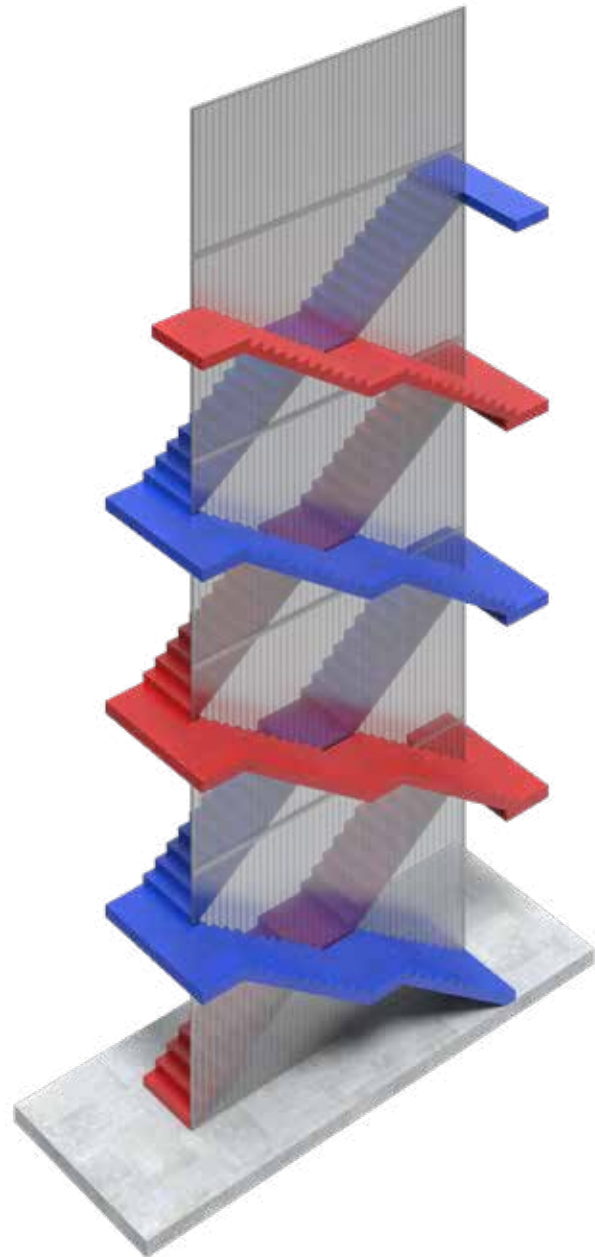
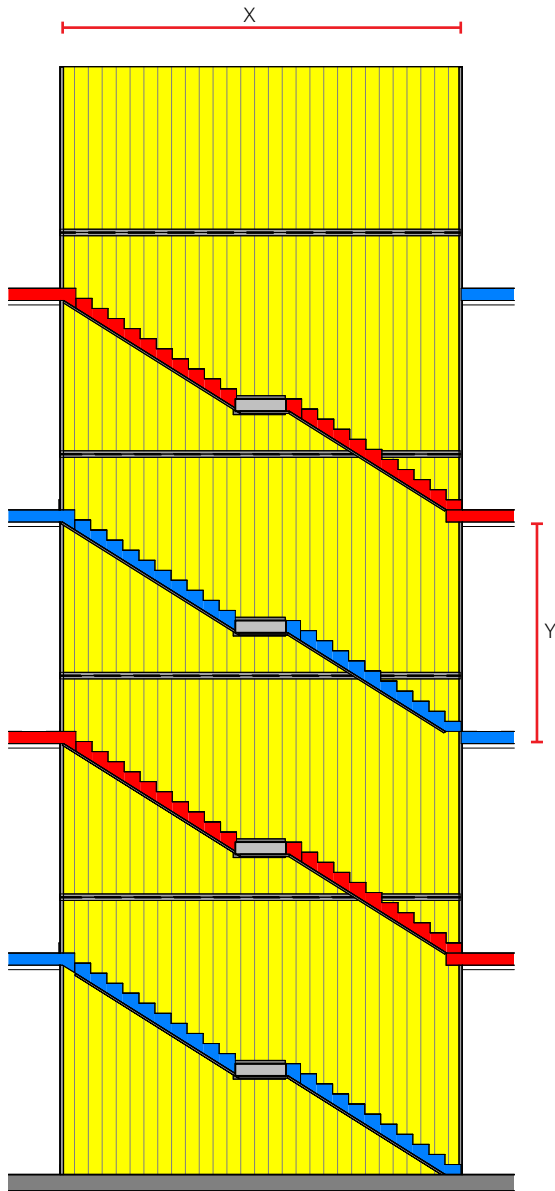

FRR -/60/60

C-TRACK BMT (MM)	X MAX (MM)	Y MAX (MM)	STAIR ANGLE BMT (MM) 0-80MM GAP
1.15	∞	4000	1.45

FRR -/120/120

C-TRACK BMT (MM)	X MAX (MM)	Y MAX (MM)	STAIR ANGLE BMT (MM) 0-80MM GAP
1.45	∞	4000	1.45

The back-to-back C-tracks must be protected by a 0.7 BMT KOROK® KIT Flashing on one side.

KOROK® SCISSOR STAIR SYSTEMS

WALL TYPE 3D (WT3D)

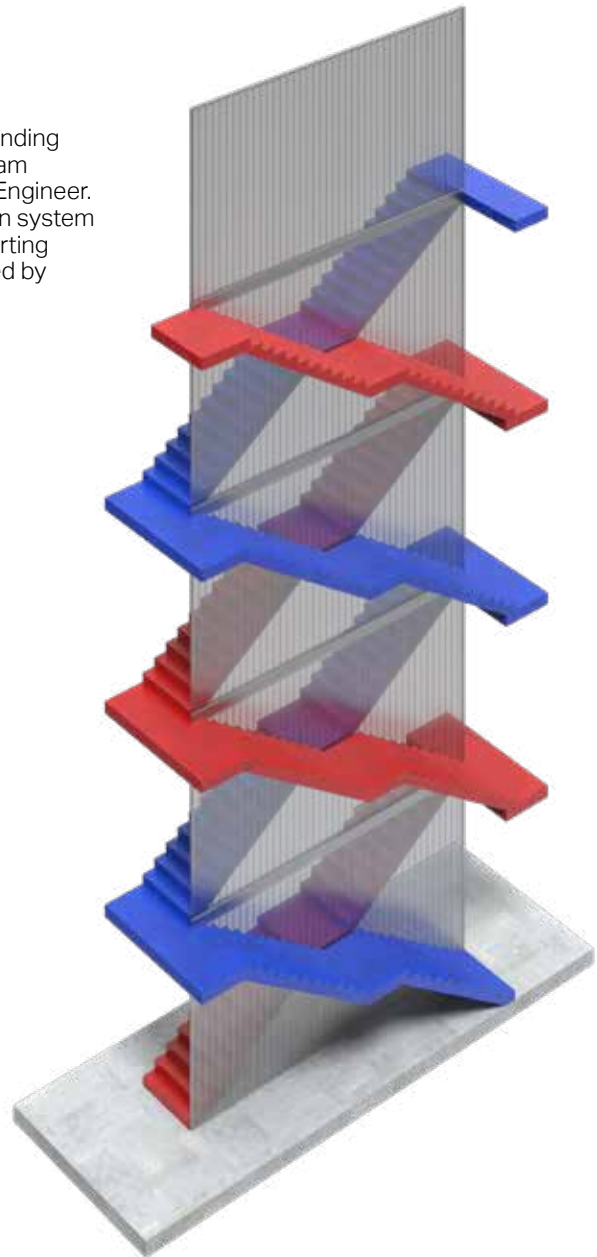
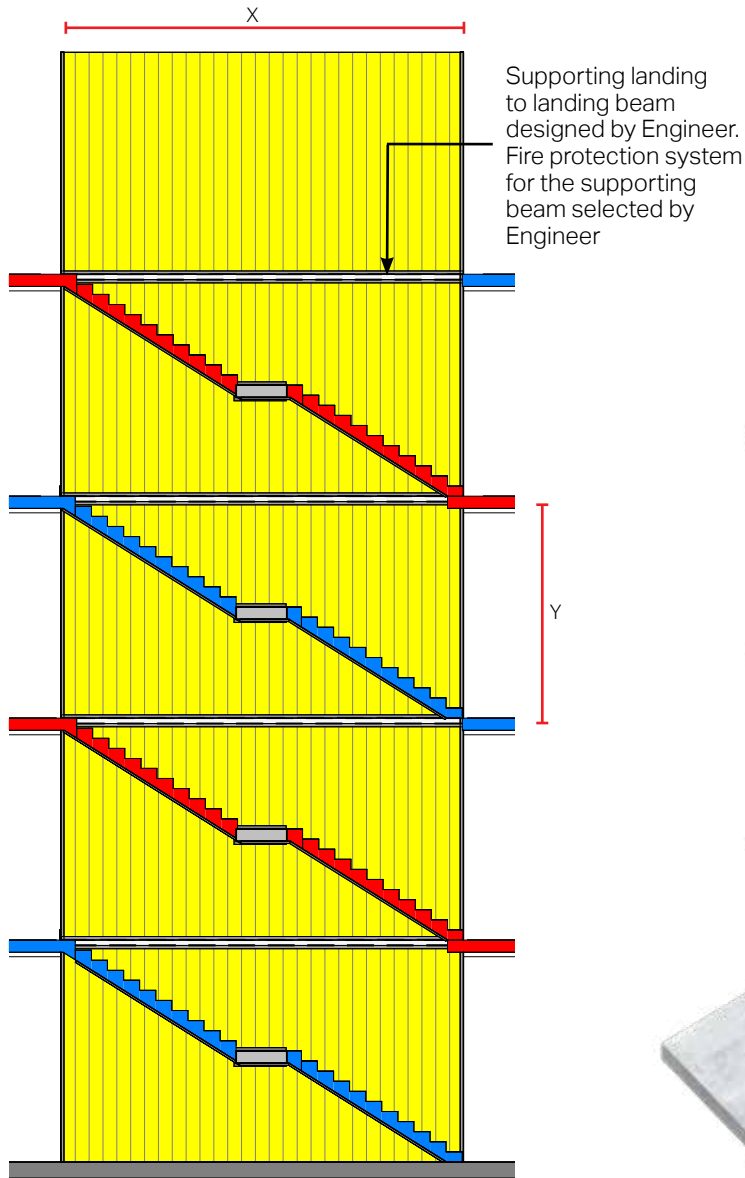

FRR -/60/60

C-TRACK BMT (MM)	X MAX (MM)	Y MAX (MM)	STAIR ANGLE BMT (MM) 0-80MM GAP
1.15	∞	6000	1.45

FRR -/120/120

C-TRACK BMT (MM)	X MAX (MM)	Y MAX (MM)	STAIR ANGLE BMT (MM) 0-80MM GAP
1.15	∞	6000	1.45

The fire protection system for the horizontal beams is selected by the engineer.
 Y max is 4000mm if hand rails are attached to the KOROK® wall.



KOROK® SCISSOR STAIR SYSTEMS INSTALLATION



INSTALLATION DETAILS SPECIFIC TO KOROK® SCISSOR STAIR SYSTEMS

1 FOR FIXINGS AND SEALANT SPECIFIC TO INSTALLING SCISSOR STAIRS SEE "KOROK® COMPONENTS SUMMARY" ON PAGE 37 OF THIS MANUAL

2 C-TRACK TO STAIR LANDINGS

1 each Hilti HUS 3-H M14 x 65mm or 2 each Hilti HUS 3-H M10 x 55mm to each C-track end.

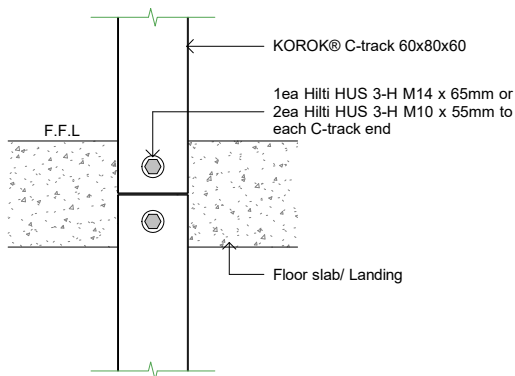

3 INSTALLING HORIZONTAL PANELS TO VERTICAL C-TRACK

KPS Wafer 10g x 30mm screws fixed through panel joints both sides

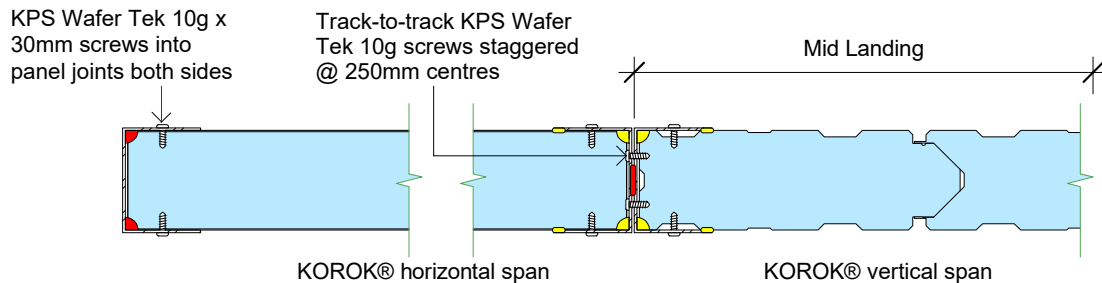

4 INSTALLING VERTICAL PANELS TO HORIZONTAL C-TRACK

KPS Wafer 10g x 30mm screws fixed through panel joints both sides

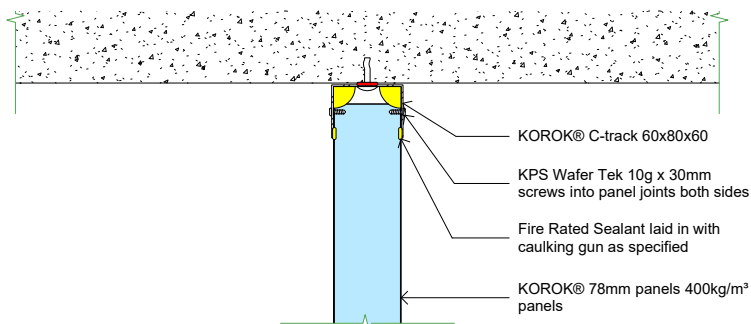

INSTALLATION DETAILS SPECIFIC TO KOROK® SCISSOR STAIR SYSTEMS

5 INSTALLING 1.45BMT ANGLE TO KOROK® PANEL AND STAIR STRINGER

KPS Wafer 10g x 30mm screws 500mm c/c max into panel joints

Hilti HUS3-P 6 x 40mm @ 500mm c/c max into the stair stinger soffit

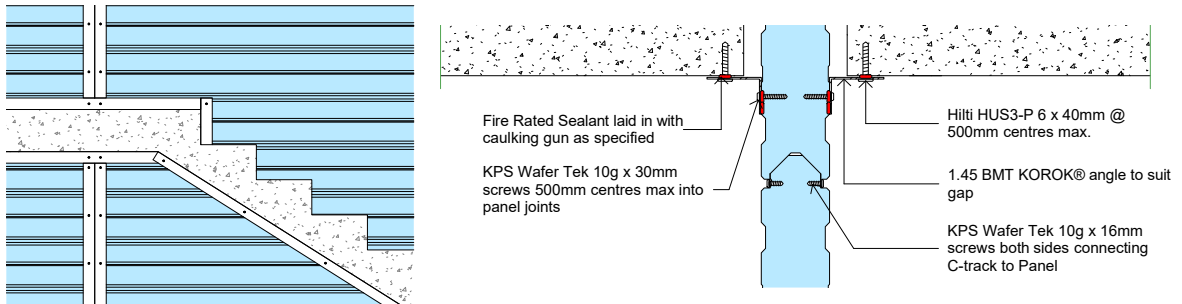

6 PANEL TO PANEL CONNECTIONS

KPS Wafer 10g x 16mm screws through panel joints at 1000mm centres (max) both sides

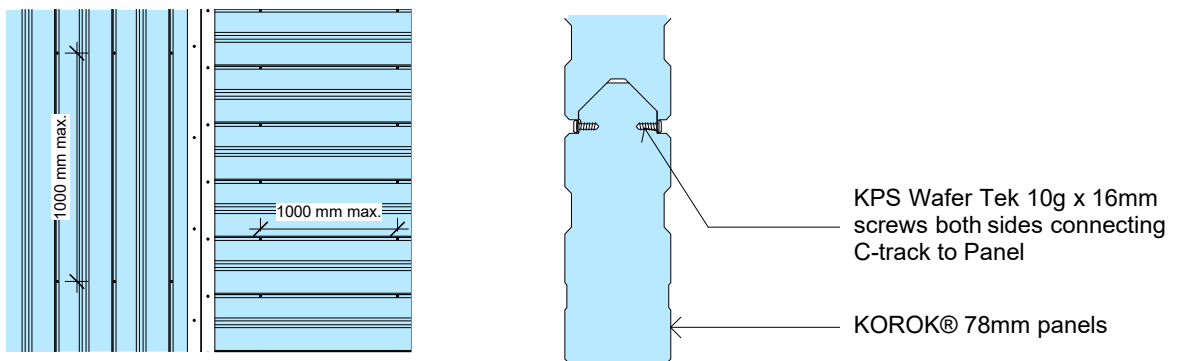

7 INSTALLING KOROK® LANDING BRACKETS FROM MID LANDING TO BACK-TO-BACK C-TRACK.

12 each KPS Wafer 10g x 30mm screws through bracket into back-to-back C-track

3 each Hilti HUS3-P 6 x 40mm through KOROK® Landing Bracket into landing soffit

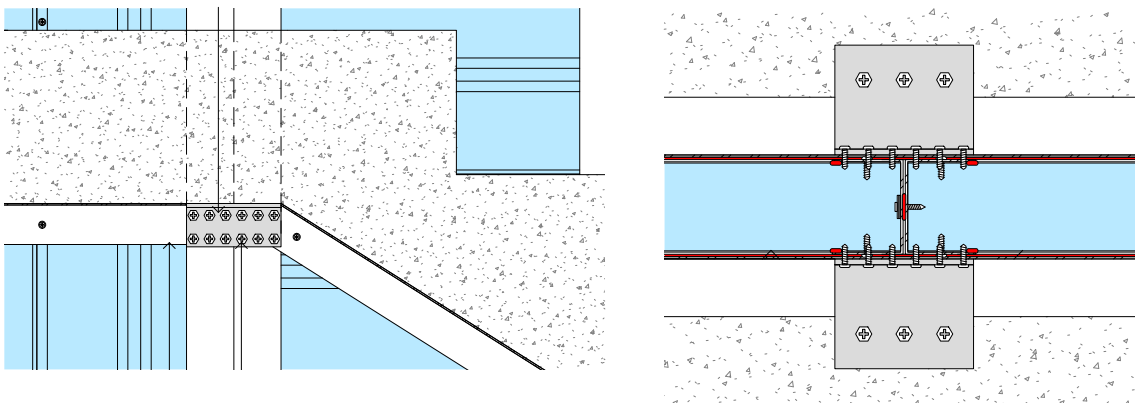

INSTALLATION DETAILS SPECIFIC TO KOROK® SCISSOR STAIR SYSTEMS

CONNECTING TO FLOOR LANDINGS

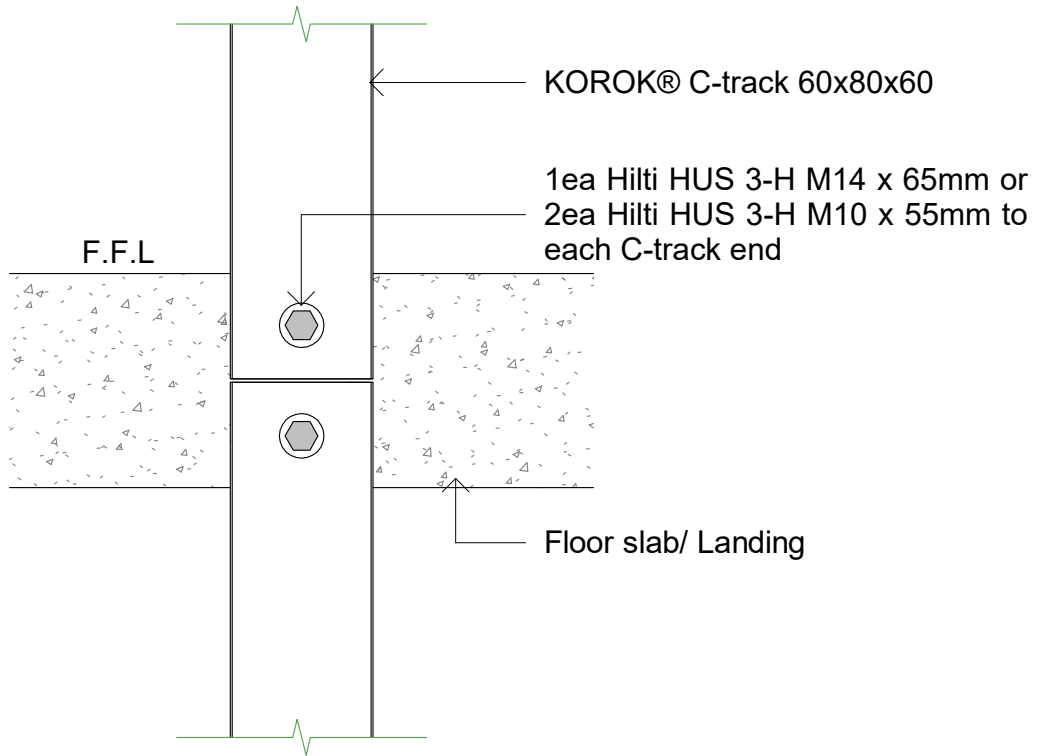

INSTALLATION DETAILS SPECIFIC TO KOROK® SCISSOR STAIR SYSTEMS

BACK-TO-BACK C-TRACK

Where transition occurs within the wall and a back-to-back C-track occurs. The C-track is fixed together with KPS Wafer 10g x 16mm screws at staggered 250mm centres with a bead of sealant between channels. A flashing must be fixed at 250mm centres top and bottom over the joint on one side of the wall.

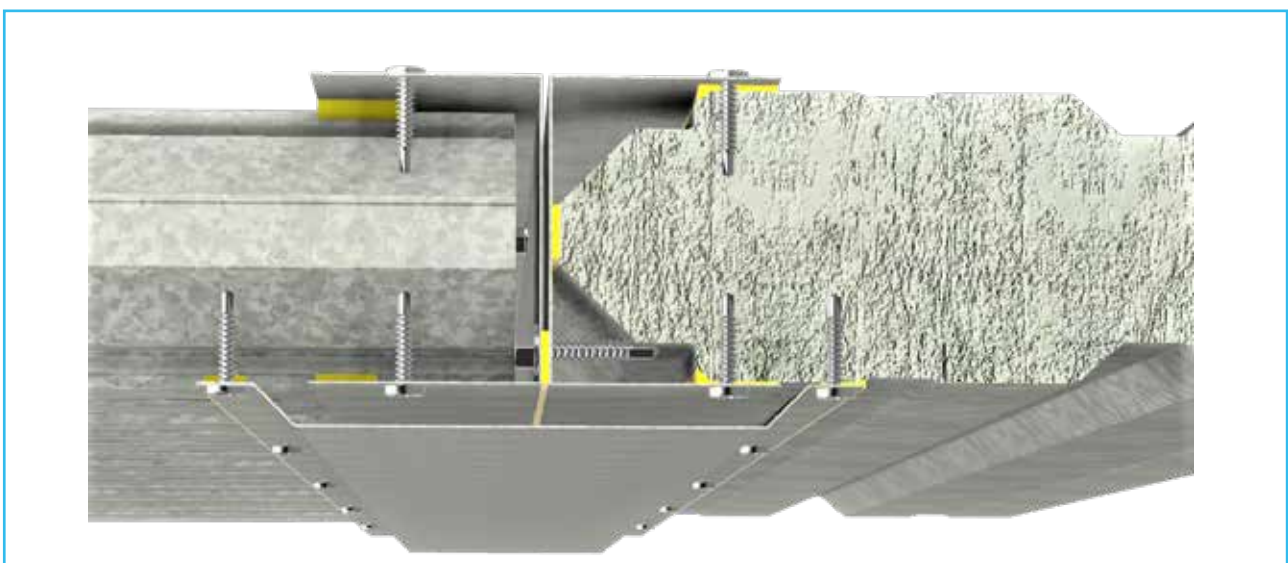
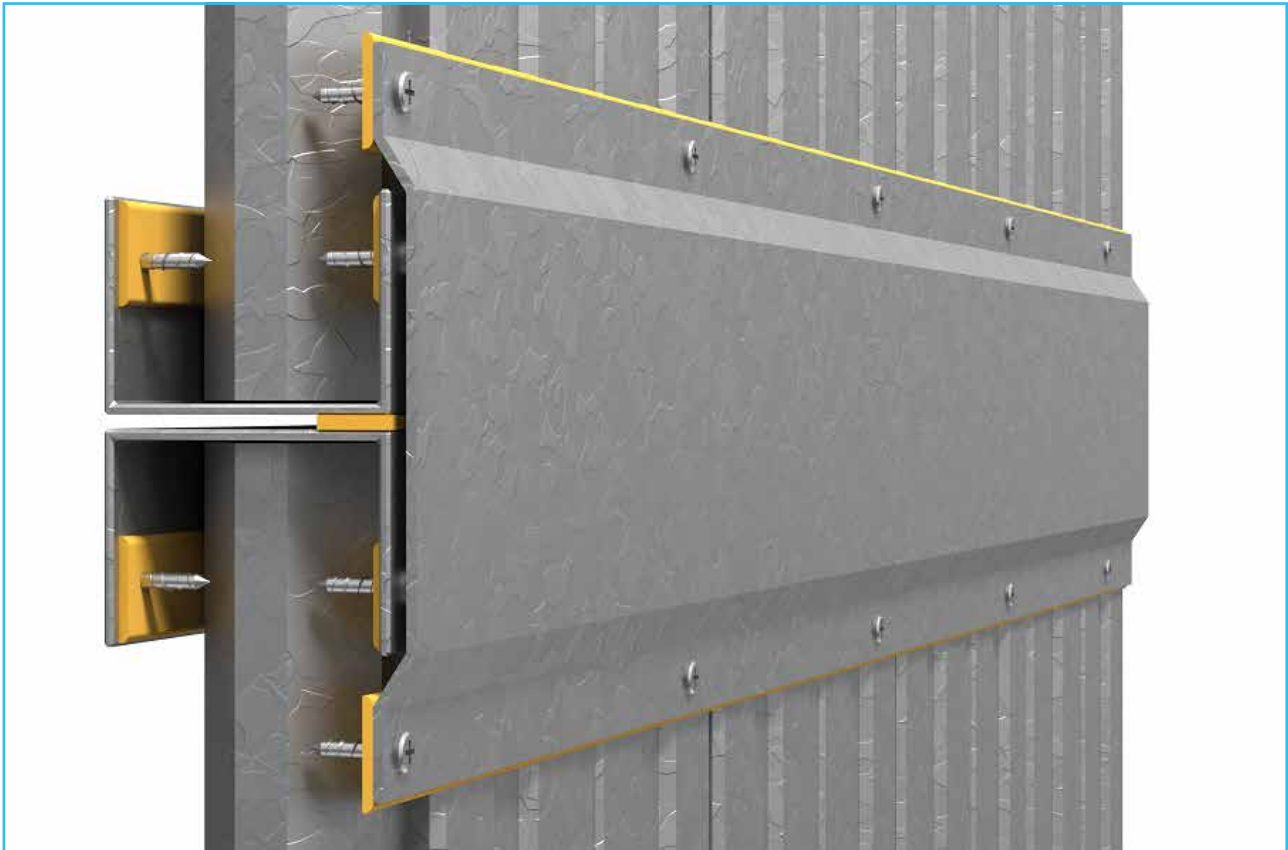

INSTALLATION DETAILS SPECIFIC TO KOROK® SCISSOR STAIR SYSTEMS

KOROK® SCISSOR STAIR WALL TO STAIR STRINGER

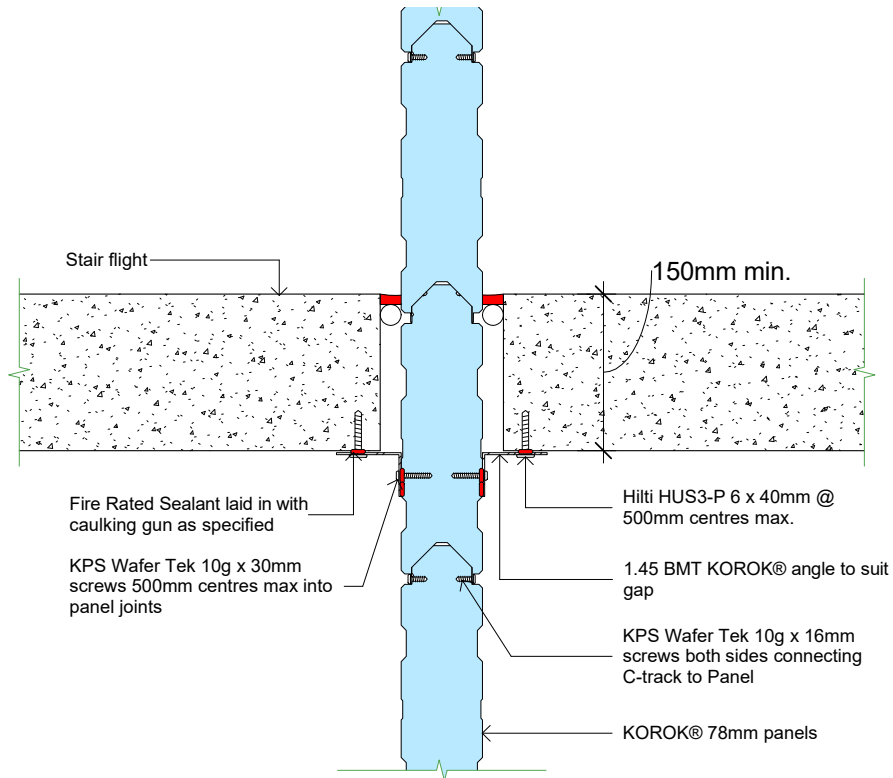

The Fire Resistance Rating (FRR) of the KOROK® Scissor Stairs in the vertical plane is provided by the stringer to wall connection details. See KOROK® Scissor Stair drawings for approved connection details.

INSTALLATION DETAILS SPECIFIC TO KOROK® SCISSOR STAIR SYSTEMS

KOROK® LANDING BRACKET

Installed with wall types 1A, 2C to support the vertical back-to-back C-track, when the mid landing is discontinuous.

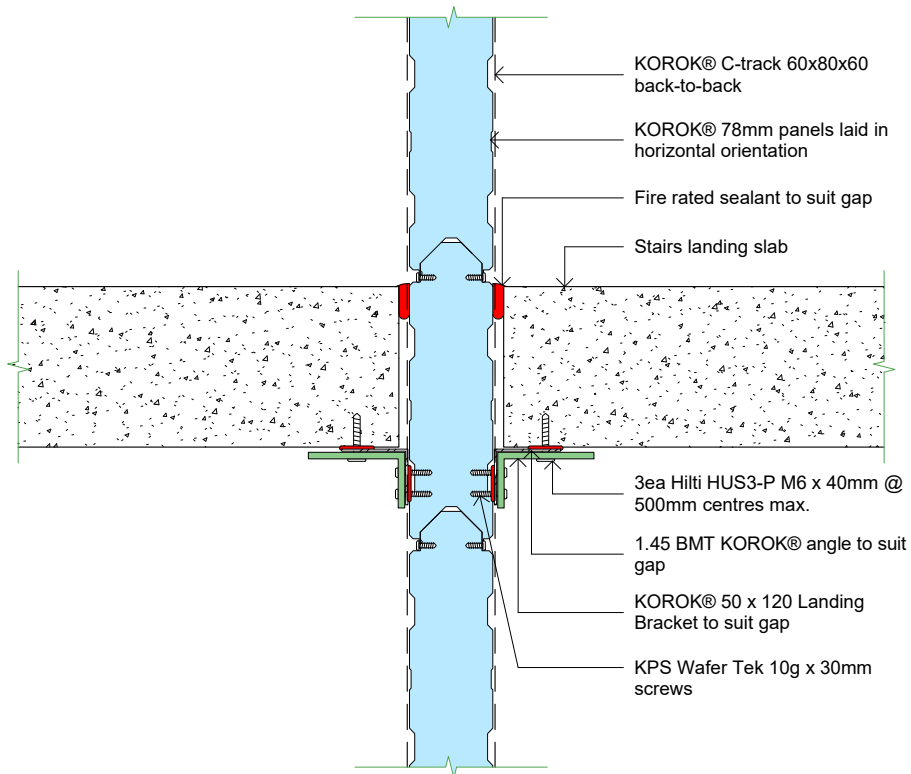

VERTICAL INSTALLATION - GENERAL DETAILS

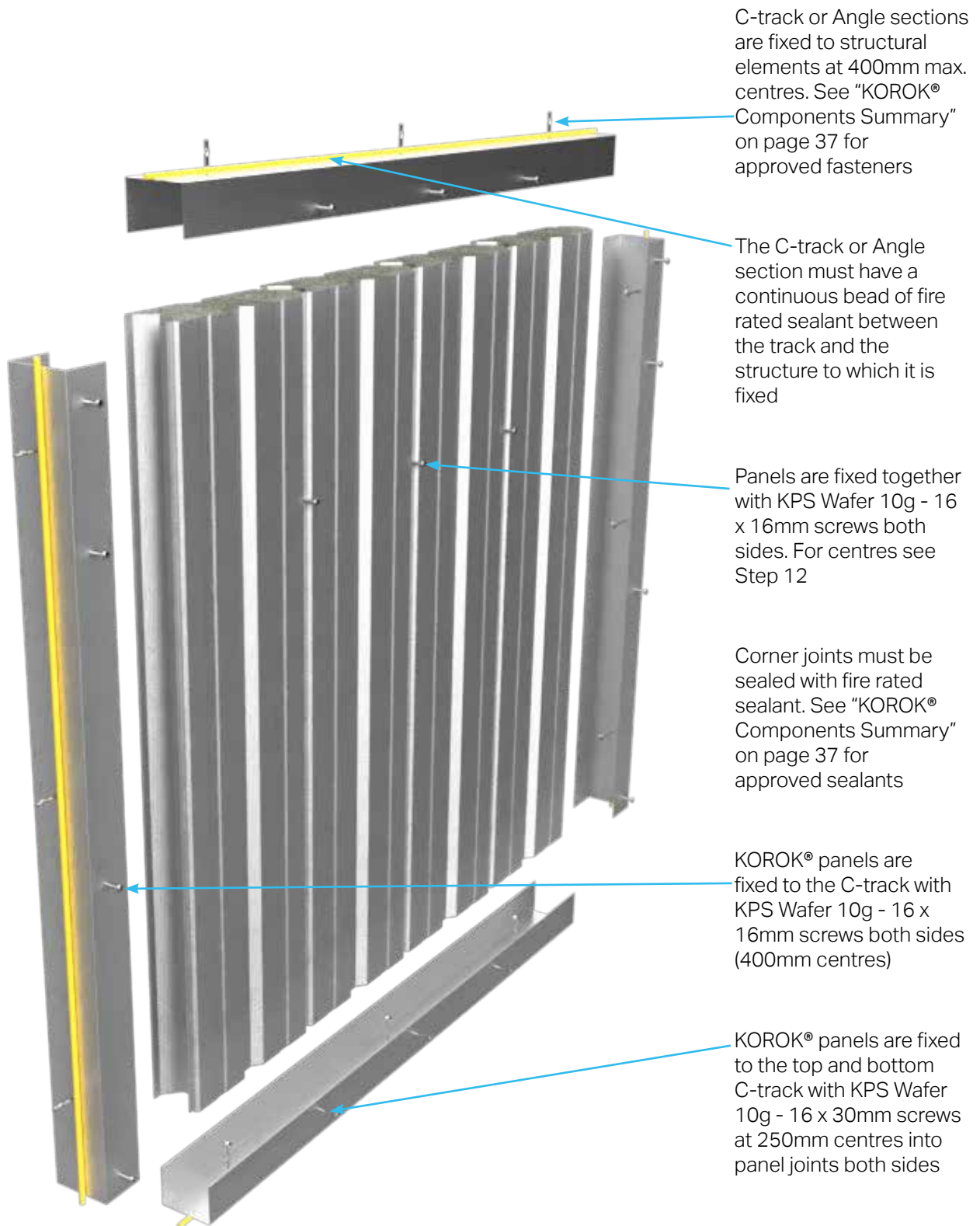

VERTICAL INSTALLATION - GENERAL DETAILS

1 Vertical installation of the KOROK® panels requires the C-track to be fixed to the supporting structure, e.g. walls, columns, portals, soffits, slabs, and landings.

Plan your setout.



2 To ensure the C-track is sealed to the structure, a continuous bead of fire-rated sealant is run around the perimeter before the C-track or Angle sections are laid and fixed.

Or the sealant can be applied directly to the C-track before fixing in place.

See figure 4 for corner C-track details.



2.1 At corners where two lengths of KOROK® C-track intersect, the C-tracks must be fixed to each other with one Wafer 10g - 16 x 16mm screw each side. The C-track is overlapped.

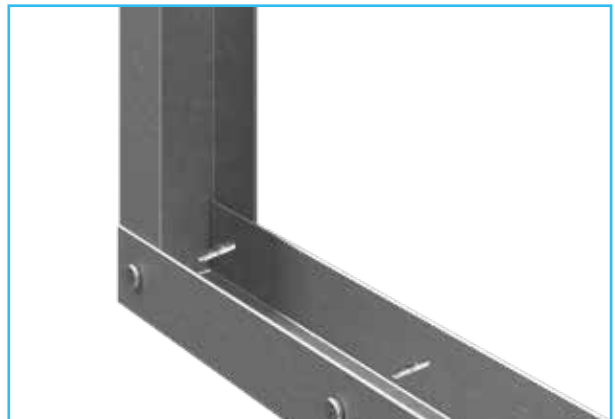

VERTICAL INSTALLATION - GENERAL DETAILS

3 Using a masonry drill bit, pre-drill the C-track at 400mm centres.

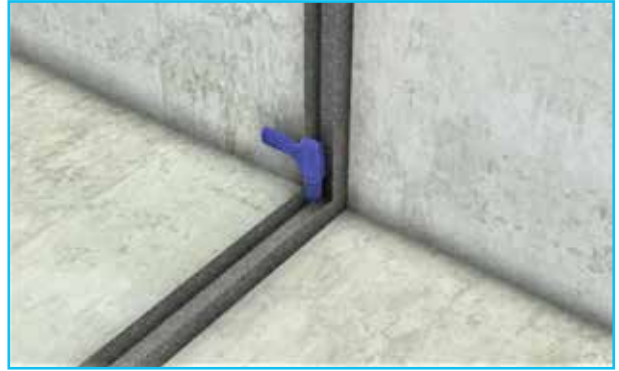

4 Then use the approved fixings to secure the C-track. See "KOROK® Components Summary" on page 37.

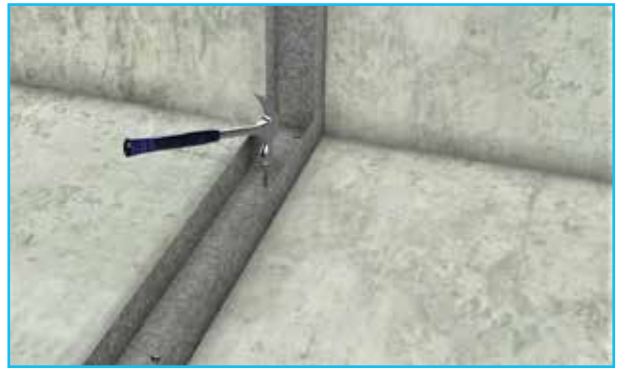

5 If the surrounding surface is uneven or if you're not sure you have a good seal, add a continuous bead of sealant around the perimeter of the C-track where it contacts the surrounding surface.



6 KOROK® panels must be cut 10mm shorter than the structural opening measurement to allow for fitting.

Where panels are supplied with protective film, pull back 300mm of the film at each end of the panels before placing the panels in the C-track.

Ensure that the first panel is plumbed vertical after fitting into the C-track. Screw fix the panel into place to the C-track.

Subsequent panels are placed in a tilt and snap action.

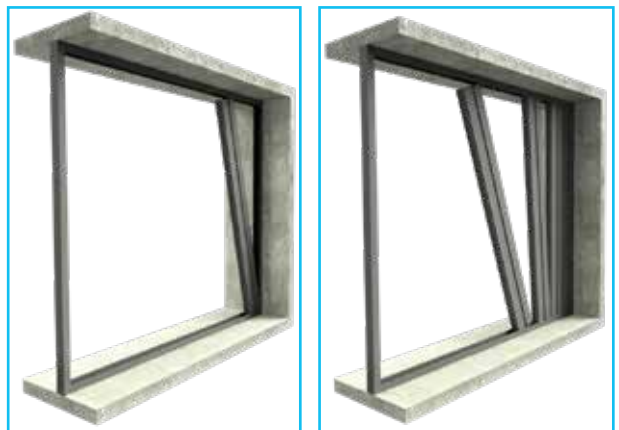

VERTICAL INSTALLATION - GENERAL DETAILS

7 Ensure the tongue and groove are fully locked to maintain the fire and acoustic performance. Remove strippable film at the end of each day's work.

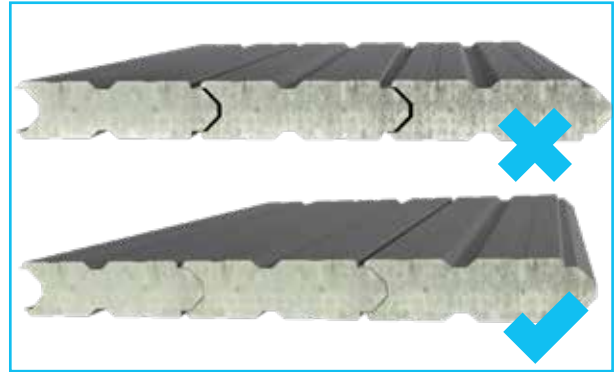

CUTTING PANELS

8 KOROK® panels can be cut to length and width using a radial saw with dust extraction. Diamond cutting discs are recommended for radial saws.

Where KOROK® panels are trimmed to width, the cut edge of the panel is fitted into the C-track and so is always the last panel abutting the wall or column. The panel is then sealed and fixed in position as usual.

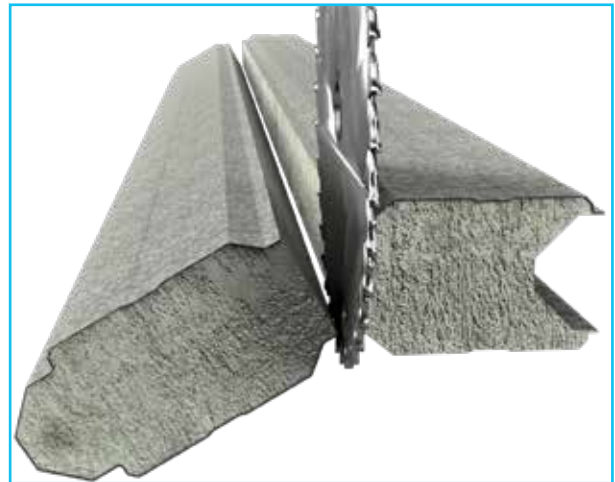

LAST PANEL

9 Stop short of the end vertical KOROK® C-track by approximately 1 metre and cut out a 600mm Angle section from the top and bottom C-track.

Plan ahead and make an allowance for a 50mm overlap onto the panels installed prior to the last remaining two panels.

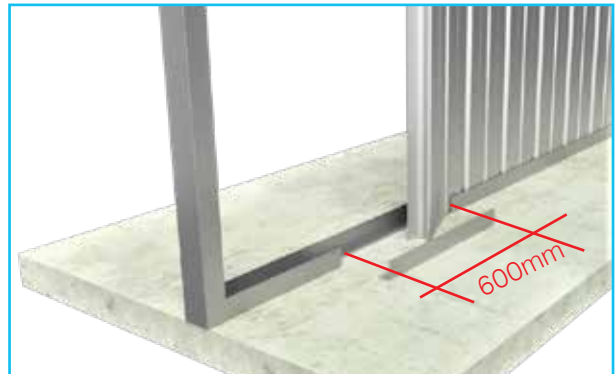

10 Cut your end panel (the last panel) ensuring that a distance of 500mm remains between panels for the last two panels to be squeezed into position.

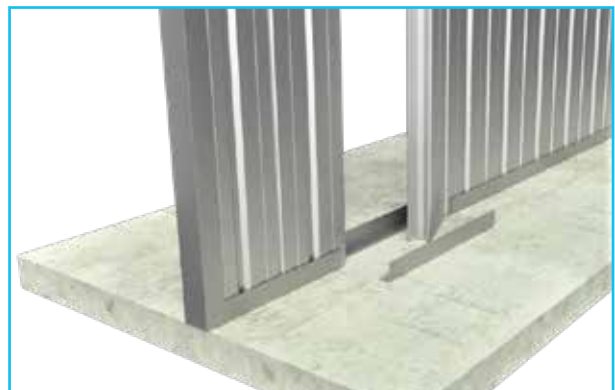

VERTICAL INSTALLATION - GENERAL DETAILS

11 Once the final two panels are in position, simply replace the Angle and fix to panels. Screw the C-track and Angle sections to the panels in the normal fashion.



SCREW PLACEMENT

12 C-TRACK

C-track is fixed to the KOROK® panels at 400mm centres on both sides on the vertical C-track, and 250mm centres on both sides into the panel joints on the horizontal C-track.

At corners where two lengths of KOROK® C-track intersect, the C-tracks must be fixed to each other with one Wafer 10g - 16 x 16mm screw each side. The C-track is overlapped. See figure 4.

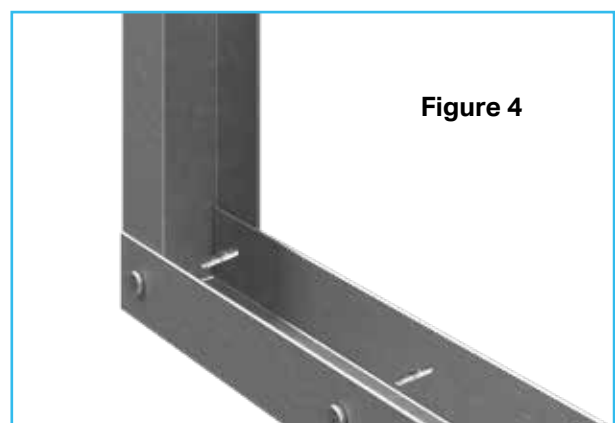
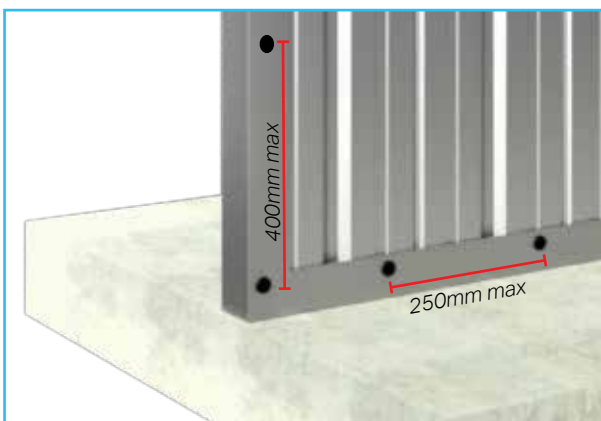

VERTICAL INSTALLATION - GENERAL DETAILS

SCREW PLACEMENT

13 Panels must be screwed together into every panel joint as per the vertical centres in **Table 1**.

TABLE 1 - SCREW PLACEMENT VERTICAL INSTALLATION

Panel Thickness	Wall Height	Maximum Centres	Sides
78mm	0 to 4m	1000mm	Both



DEFLECTION C-TRACK DETAILS

Dead and live loads can cause significant deflection in some structures.

KOROK® can provide deflection C-track details where deflection loadings are considered.

VERTICAL INSTALLATION - GENERAL DETAILS

SEALANT PLACEMENT

14 Remove any remaining plastic film and then apply a continuous bead of fire rated sealant between the KOROK® C-track and the KOROK® panels as indicated by the yellow line.



15 Fire rated sealant details for top and sides.

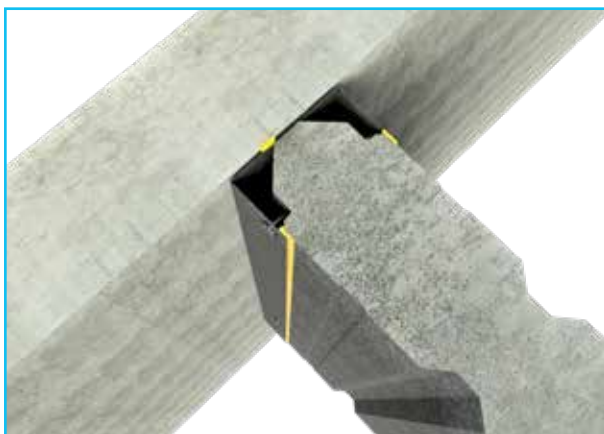

VERTICAL INSTALLATION - GENERAL DETAILS

16 Using Angle as an alternative to C-track.



FINAL CHECK

At the completion of the job and at the finish of each day's work, it is essential that the completed area be thoroughly cleaned of all swarf, rivet stems, nails, drillings and screws etc. normally associated with the installation of metal KOROK® panels. Remove any remaining strippable film, check all fixings are correctly installed, all fire and acoustic sealant is applied correctly.

HORIZONTAL INSTALLATION - GENERAL DETAILS

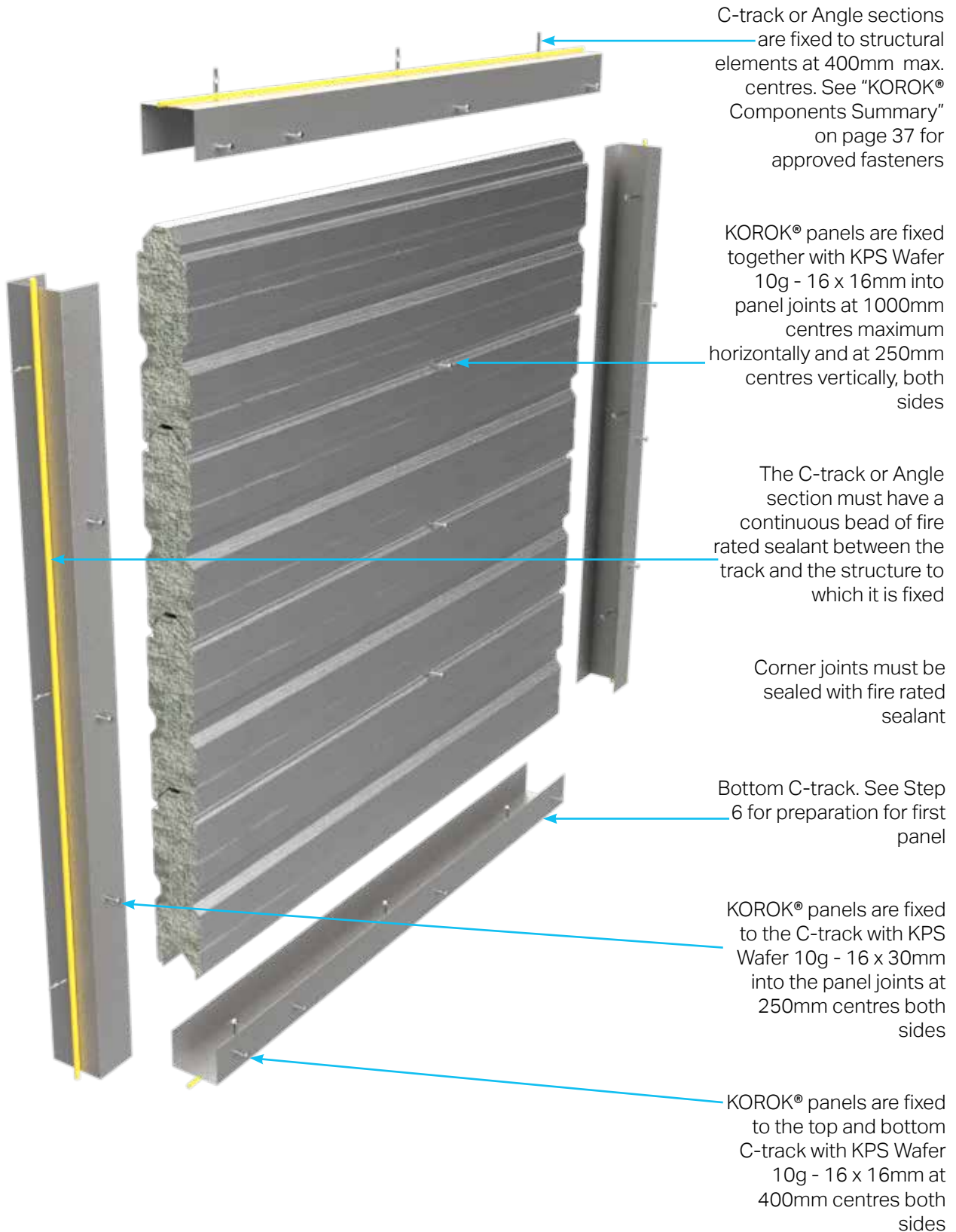

HORIZONTAL INSTALLATION - GENERAL DETAILS

1 Horizontal Installation of the KOROK® panels requires the C-track to be fixed to the supporting structure, e.g. walls, columns, portals, landings etc.

Plan your setout.

The top of the last vertical C-track must be cropped as per Step 10 prior to installation, to allow the top and last horizontal panel to be installed.



2 To ensure the C-track is sealed to the structure, a continuous bead of fire rated sealant is run around the perimeter before the C-track or Angle sections are laid and fixed.

Or the sealant can be applied directly to the C-track before fixing in place.

The soffit track will generally be two Angles. See Last Panel details starting at Step 10.

See figure 5 for C-track corner details.



2.1 At corners where two lengths of KOROK® C-track intersect, the C-tracks must be fixed to each other with one Wafer 10g - 16 x 16mm screw each side. The C-track is overlapped.

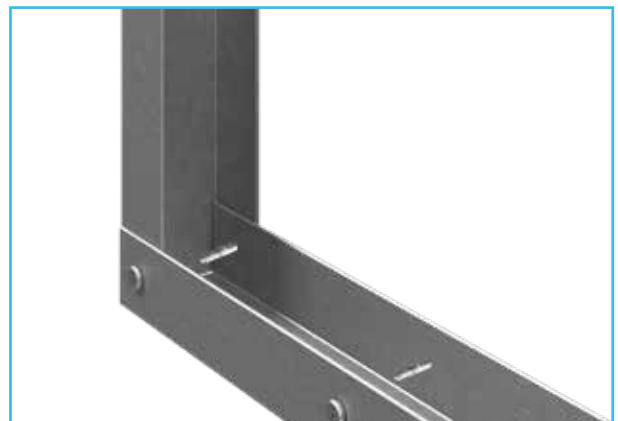

HORIZONTAL INSTALLATION - GENERAL DETAILS

3 Using a masonry drill bit, pre-drill the C-track at 400mm centres.

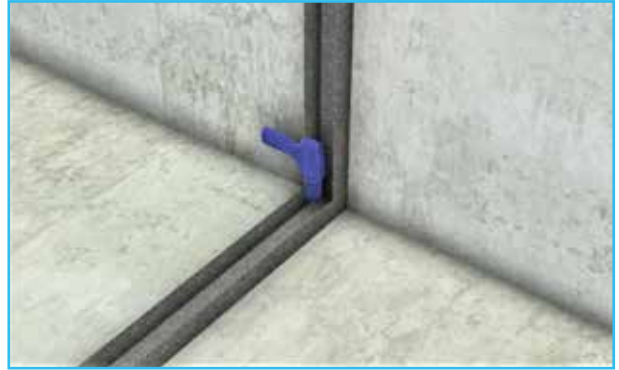

4 Then use the approved fixings to secure the C-track. See "KOROK® Components Summary" on page 37.

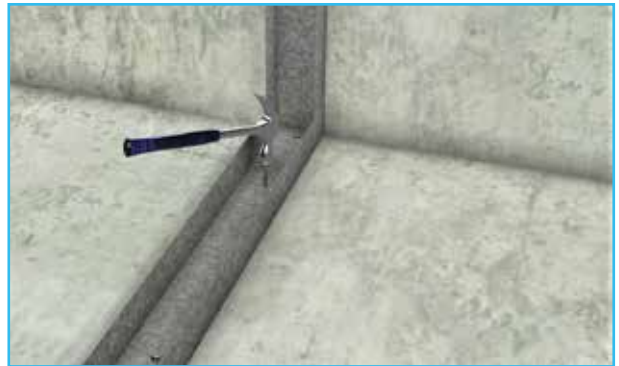

5 If the surrounding surface is uneven or if you're not sure you have a good seal, add a continuous bead of sealant around the perimeter of the C-track where it contacts the surrounding surface.



HORIZONTAL INSTALLATION - GENERAL DETAILS

6 For horizontal installs where the wall width is greater than 5.5m OR where the load is transferred to the ground (e.g. 4-sided plant room), grout or a panel nose must be used in the bottom C-track.

6.1 Grout is poured into the bottom C-track just prior to the installation of the KOROK® panels. This forms a bearing surface for the female end of the panel.

The cementitious grout must be non-shrink high performance (Hilti® CM651-48 or similar).

Fill the C-track to a depth of 25-30mm. Any overflow when the panel is placed in the C-track must be wiped off immediately.

Ensure the first panel is level after fitting into the track and grout and fix off.

OR

6.2 Alternatively the male nose of the top panel can be cut off and placed in the female end of the bottom panel to provide the same support.

Ensure the first panel is level after fitting into the track and fix off.

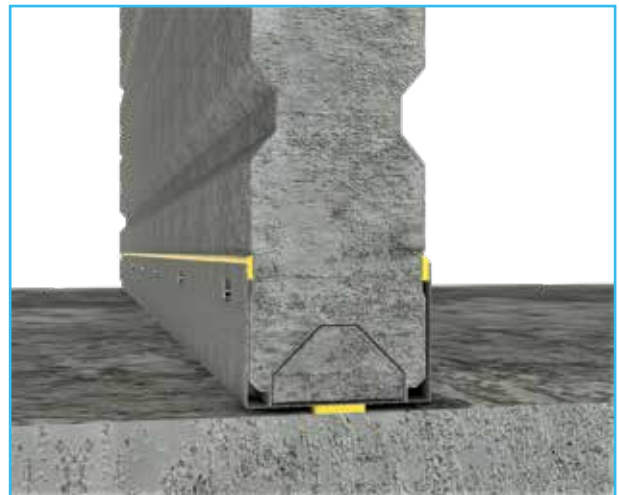
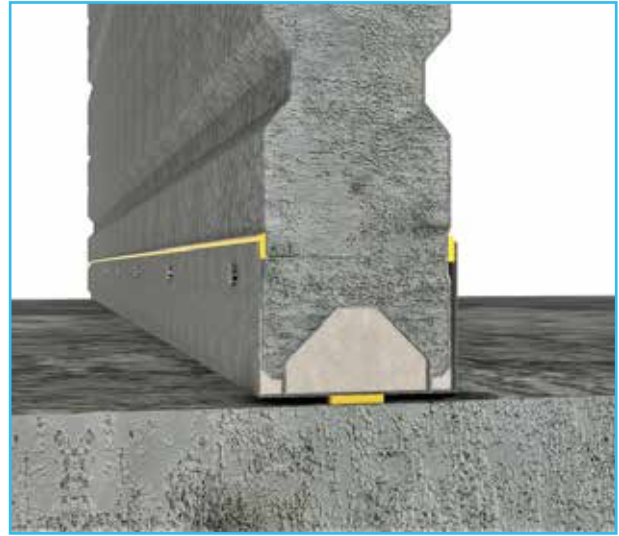

HORIZONTAL INSTALLATION - GENERAL DETAILS

7 KOROK® panels must be cut 30mm shorter than the structural opening measurement to allow for fitting.

Where panels are supplied with protective film, pull back 300mm of the film at each end of the panels before placing the panels in the C-track.

Ensure that the first panel is level after fitting into the C-track. Screw fix the first panel into place to the C-track.

Before fitting the next panel, each horizontal KOROK® panel is to be fixed to the vertical C-track with KPS Wafer 10-16x30 screws at 250mm centres at the panel joints on both sides.

This is to avoid loading of the panel below.

Panels are placed in a tilt and snap action.

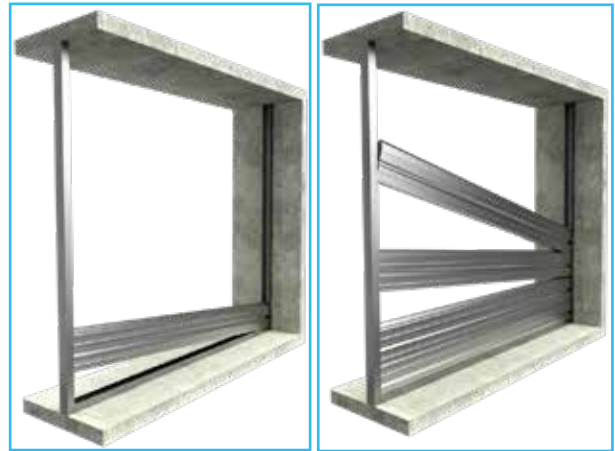

8 Ensure the panels are clicked together correctly to maintain the fire and acoustic performance. Remove strippable film at the end of each day's work.



CUTTING PANELS

9 KOROK® panels can be cut to length and width using a radial saw with dust extraction. Diamond cutting discs are recommended for radial saws.

Where KOROK® panels are trimmed to width, the cut edge of the panel is fitted into the C-track and so is always the last panel abutting the floor or soffit. The panel is then sealed and fixed in position as usual.

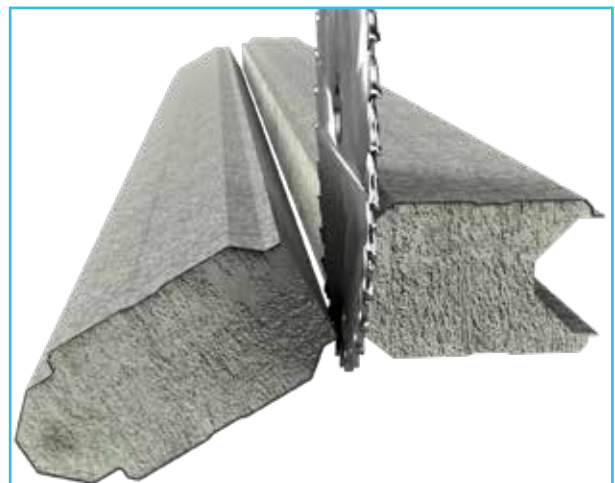

HORIZONTAL INSTALLATION - GENERAL DETAILS

LAST PANEL

10 To get the last horizontal panel in, cut out a 300mm angle section from each of the side C-tracks. Keep these two 300mm angle sections for use in Step 12.

11 Keep placing the panels into the panel below. Screw off panel to C-track both sides every time a new panel is installed.

12 Once the last panel is in position, fix the pieces of C-track, that were removed in Step 10, back in place. Fire-rated sealant is then applied.

13 Angle is then fixed to the soffit at 400mm centres, then fixed to the panel at 400mm centres. Fire rated sealant is applied.

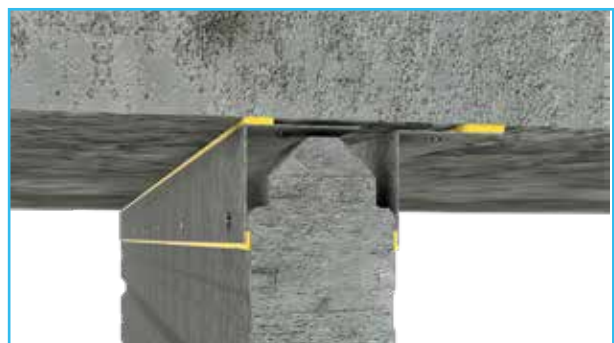
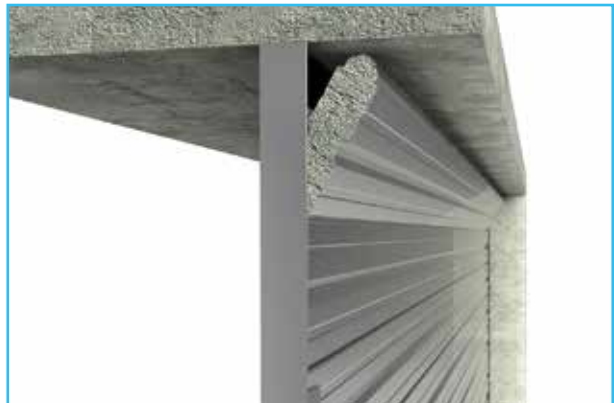

HORIZONTAL INSTALLATION - GENERAL DETAILS

SCREW PLACEMENT

14 Panels are screwed together into every panel joint at the horizontal centres shown in **Table 2** below.

TABLE 2 - SCREW PLACEMENT HORIZONTAL INSTALLATION

Panel Thickness	FRR	Wall Height	Panel Span	Maximum Centres	Sides
78mm	-/60/60	0 to unlimited	0 to 5.5m	1000mm	Both
78mm	-/120/120	0 to unlimited	0 to 5.0m	1000mm	Both



HORIZONTAL INSTALLATION - GENERAL DETAILS

SCREW PLACEMENT

C-TRACK

The KOROK® panels are fixed to the C-track with KPS Wafer 10g - 16 x 30mm screws at 250mm centres into the panel joints on both sides on the vertical C-track, and with KPS Wafer 10g - 16 x 16mm screws at 400mm centres on both sides on the horizontal C-track.

At corners where two lengths of KOROK® C-track intersect, the C-tracks are over-lapped (figure 5) and must be fixed to each other with at least 1 Wafer 10g - 16 x 16mm screw each side.

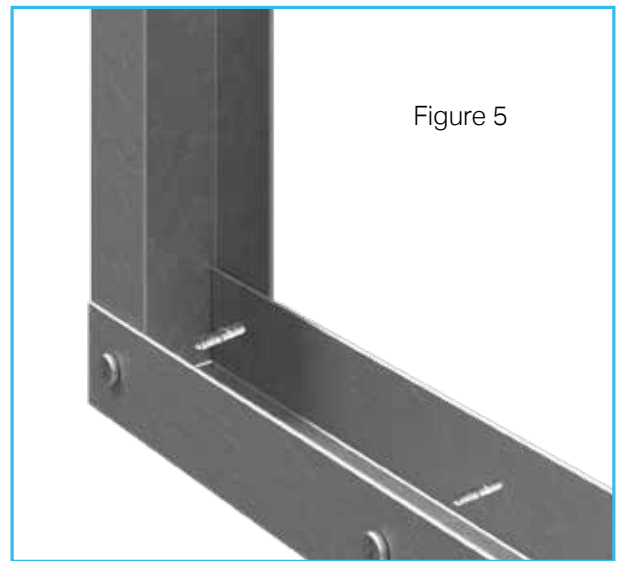

DEFLECTION C-TRACK DETAILS

Dead and live loads can cause significant deflection in some structures.

KOROK® can provide deflection C-track details where deflection loadings are considered.

HORIZONTAL INSTALLATION - GENERAL DETAILS

SEALANT PLACEMENT

15 Remove any plastic film and then apply a fire rated sealant. See drawings for sealant locations.

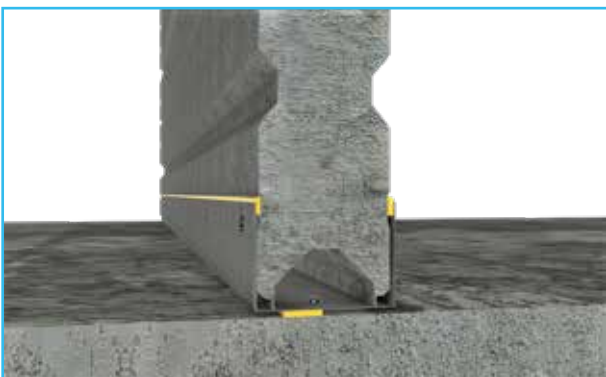
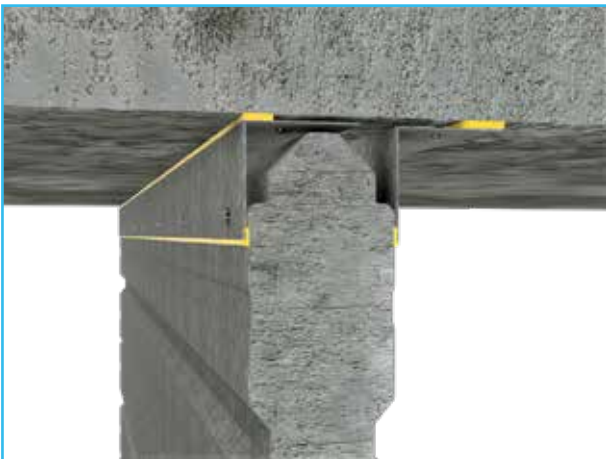

16 Fire rated sealant details for top, bottom and sides.



FINAL CHECK

At the completion of the job and at the finish of each day's work, it is essential that the completed area be thoroughly cleaned of all swarf, rivet stems, nails, drillings and screws etc. normally associated with the installation of metal KOROK® panels. Remove any remaining strippable film, check all fixings are correctly installed, all fire and acoustic sealant is applied correctly.

KOROK® COMPONENTS SUMMARY

Product Image	Item Description
	PN1140 KOROK® C-track 60 x 80 x 60mm 1.15B.M.T.
	PN1154 3.0m C Track 60x80x60 1.45BMT 3.0m PN1155 4.0m C Track 60x80x60 1.45BMT 4.0m
	PNAB30 KOROK® Landing Bracket 52x95x6
	PNAB40 KOROK® Landing Bracket 52x155x8
	PN1130 KOROK® panel 78mm wide 250mm cover 400 kg/m ³ density (Colour)
	PN1318 KOROK® GEN 2 panel 78mm wide 250mm cover 400 kg/m ³ density (Galvanised)
	PN1190 6.5 x 32 Rawl Mushroom spikes
	PN1170 KPS Wafer 10-16x16 Class 3
	PN1171 KPS Wafer 10g - 16 x 30 Class 3

Product Image	Item Description
	PN1157 KOROK MS Fire Seal
	PN1161 KOROK Acrylic Fire Seal
	PN1165 Sikaflex-400 Fire-rated Sealant
	PN1160 Hilti CP606
	PN1198 Hex Head Type 17 14g x 35mm
	PN1174 Hex Head SDS 14g x 22mm
	PN1187 Hilti X-ENP-19 L15 fasteners (strip of 10)
	PN1186 Hilti DX76 yellow charges
	PN1235 KOROK® KIT flashing
	PN1156 KOROK® Angle 50x110galv 1.45BMT
	PN1310 Hilti HUS3-P 6 Concrete screw anchor
	PN1343 Hilti HUS3-H 6 Concrete screw anchor

KOROK® PANEL PROPERTIES: 78MM 400KG/M³

KOROK® PANEL PROPERTIES

- Base Metal Thickness 0.4mm B.M.T.
 - Mass kg per lineal metre 10.2 nominal
 - Mass kg/m² 40.8 nominal
- EI** 60 kNm² per panel (*bending stiffness, minor axis*)
- EI** 387 kNm² per panel (*bending stiffness, major axis*)
- EA** 4060 kN per panel (*axial stiffness*)
- GJ** 583 kNm² per panel (*torsional stiffness*)

VERTICAL SPAN WALLS

- Maximum bending moment / panel 1.43 kNm (ULS)
- Maximum axial end crush force / panel 25 kN (ULS)
3.4 kN (SLS)
- Maximum horizontal reaction (crushing on flat) / panel
8.9 kN (ULS) 3.1 kN (SLS)

HORIZONTAL SPAN WALLS

- Maximum bending moment / panel 1.43 kNm (ULS)
- Maximum axial edge crush force per unit length
17 kN/m (ULS) 6k N/m (SLS)
- Maximum horizontal reaction / panel 8.9 kN (ULS)
3.1 kN (SLS)

THERMAL RESISTANCE

- R Value 0.30 (m²K)/W
- U Value 3.2 W/(m²K)

DEFINITIONS

ULS: Value shown is for Ultimate Limit State loading

SLS: Value shown is for Serviceability Limit State loading

USE OF TABLES

1. These Span Tables are based on ambient conditions.
2. When used as part of a fire-rated system, the maximum unsupported vertical span of the KOROK® 78mm panel is 6.0 metres. The maximum unsupported horizontal span of the KOROK® 78mm panel is 5.0 metres. Greater spans or walls where additional load carrying capacity is required are subject to specific engineering design and/or fire engineering assessment.
3. Shelf loading requires specific engineering design.
4. Determine the loads on the KOROK® wall in accordance with AS/NZS 1170.0.

5. Use **Table 4 - Horizontal Span** to ensure that walls spanning horizontally can carry the loads previously calculated. Use **Table 5 - Vertical Span** to ensure that walls spanning vertically can carry the loads previously calculated. Interpolation of points in the tables is allowed.
6. The Tables have been generated for a range of deflection limits i.e. Span/150, Span/200, Span/250, Span/300 in both the vertical and horizontal KOROK® panel configurations.
7. The walls must be checked for both ultimate limit state (ULS) loading and serviceability limit state (SLS) loading.
8. Vertical Span Tables have been generated to a maximum unsupported span of 8.0 metres height.
9. Horizontal Span Tables have been generated based on a 14.0 metres high wall.
10. For horizontal panel unsupported spans over 5.0 metres, for maximum wall heights please contact us at KOROK® on 0800 773 777.

DEFLECTION C-TRACK DETAILS

Dead and live loads can cause significant deflection in some structures.

KOROK® can provide deflection C-track details where deflection loadings are considered.

Contact your KOROK® representative on 0800 773 777 for a solution specific to your project.

SUPPORTING STRUCTURES

KOROK® walls must be supported. The supporting structures themselves must be specifically designed to carry the load of the KOROK® walls.

The fastener strengths shown in this section may be used to design the connections. Maximum spacing of fasteners is shown on installation information.

INSTALLATION NOTE

All KOROK® C-track to structure, KOROK® C-track to KOROK® panel, and KOROK® panel to KOROK® panel connections shall be in accordance with details specified in this manual unless specified otherwise by the Project Engineer.

KOROK® PANEL PROPERTIES: 78MM 400KG/M³

TABLE 3 - SHEAR STRENGTH PER FASTENER FOR THE FOLLOWING CONNECTIONS

CONNECTION	LOAD DIRECTION	TYPE	DESIGN STRENGTH (KN) ULS	DESIGN STRENGTH (KN) SLS
Panel to panel	In-plane	10x16 galvanised Steeltite wafer head screws	1.01	0.83
Panel sides to C-track	In-plane	10x16 galvanised Steeltite wafer head screws	0.95	0.78
Panel sides to C-track	Out-of-plane	10x16 galvanised Steeltite wafer head screws	0.91	0.74
Panel ends to C-track	In-plane	10x16 galvanised Steeltite wafer head screws	0.91	0.74
Panel ends to C-track	Out-of-plane	10x16 galvanised Steeltite wafer head screws	2.21	0.77
C-track to concrete	In-plane	6.5x32 Rawl Mushroom spikes	7.84	2.27
C-track to concrete	Out-of-plane	6.5x32 Rawl Mushroom spikes	7.84	2.27
C-track to steel support	In-plane	Hilti® X-ENP-10 L15 Nails	4.32	2.31
C-track to steel support	Out-of-plane	Hilti® X-ENP-10 L15 Nails	4.32	2.31
KOROK® aluminium bracket to panel joint	Out-of-plane	Hex Head Type 17 14g x 35mm screws	0.92	0.92

TABLE 4 - HORIZONTAL SPAN

SPAN (M)	ULS DESIGN	SLS DESIGN L/150	SLS DESIGN L/200	SLS DESIGN L/250	SLS DESIGN L/300
2	10.05		9	7.7	6.7
2.5	7.3	6.02	4.94	4.2	3.64
3	5.04	3.7	3	2.5	2.17
3.5	3.7	2.42	1.95	1.63	1.39
4	2.82	1.67	1.34	1.1	0.94
4.5	1.94	1.19	0.94	0.78	0.66
5	1.37	0.88	0.69	0.56	0.47
6	0.72	0.51	0.39	0.32	0.26
7	0.38	0.31	0.23	0.19	0.15
8	0.17	0.17	0.14	0.11	0.09

Maximum pressure that can be resisted by a horizontal span (kPa)
 Horizontal Span Table has been generated based on a 14m high wall.
 For unsupported horizontal spans over 5.0m please contact us at KOROK® on 0800 773 777 for maximum wall heights.

TABLE 5 - VERTICAL SPAN

SPAN (M)	ULS DESIGN	SLS DESIGN L/150	SLS DESIGN L/200	SLS DESIGN L/250	SLS DESIGN L/300
2	10.05		9.05	7.75	6.77
2.5	7.3	6.05	4.95	4.2	3.64
3	5.04	3.7	3	2.53	2.18
3.5	3.7	2.42	1.96	1.64	1.4
4	2.82	1.68	1.34	1.12	0.95
4.5	2.23	1.21	0.96	0.79	0.67
5	1.79	0.9	0.71	0.58	0.49
6	1.22	0.54	0.42	0.34	0.28
7	0.89	0.34	0.26	0.21	0.17
8	0.66	0.23	0.17	0.14	0.11

Maximum pressure that can be resisted by a vertical span (kPa)
 Vertical Span Table has been generated to a maximum of 8m wall height. Length of the wall is not a consideration when calculating span.



**KOROK® SCISSOR STAIR
SYSTEMS DRAWINGS**



**KOROK® Scissor Stair
Systems DRAWINGS
Available Online. Click
here**

https://korok.com/library#_korok_market%20segment=Scissor%20Stairs

SUSTAINABILITY

KOROK® is a high performance product with minimal impact on the planet

KOROK® is made to order, ensuring minimal on-site waste

KOROK® is fully re-usable

KOROK® is fully recyclable

KOROK® is manufactured in NZ

Declare.

KOROK panel
KOROK Building Systems NZ Ltd

Final Assembly: Hamilton, New Zealand
Life Expectancy: 50 Year(s)
End of Life Options: Salvageable/Reusable in its Entirety, Recyclable (100%)

Ingredients:

Inner Core: Portland Cement; Water; **Fly Ash**; Washed Fine Sand; Anionic Detergent Blend; Nonionic Surfactant; Polypropylene Filaments; **Outer Steel Shell :** Low Carbon Steel; Antimony; Zinc

Living Building Challenge Criteria: Compliant

I-13 Red List:

LBC Red List Free % Disclosed: 100% at 100ppm
 LBC Red List Approved VOC Content: Not Applicable
 Declared

I-10 Interior Performance: Not Applicable

I-14 Responsible Sourcing: Not Applicable

KOR-0001
EXP. 01 OCT 2025
Original Issue Date: 2018

FOR FULL LBC RED LIST RESPONSIBILITY LABEL, VISIT: living-future.org/declare

 **NZGBC**
TE KAUNIHERA HANGANGA TAUTAIAO

Member 2024-2025

 **EPD**®
AUSTRALASIA
ENVIRONMENTAL PRODUCT DECLARATION



KOROK 

22 Norris Ave
PO Box 20182
Te Rapa, Hamilton
0800 773 777
www.korok.com