



**KOROK®**

# **TECHNICAL & INSTALLATION MANUAL**



**NOVEMBER 2023**

**Version 55**

**KOROK**   
FIRE AND ACOUSTIC WALL SYSTEMS



This manual has been developed using recognised Australian and New Zealand standards together with sound engineering principles substantiated through BRANZ.

This manual in no way supersedes the requirements of any Statutory Authority or New Zealand Building Code but is rather a guide to the performance of KOROK® under certain loading conditions.

The manual provides builders, engineers, designers and architects with a user-friendly format for installing and designing KOROK® for non-load bearing applications.

In brief, KOROK® has:

- Fire rated systems ranging from 30 minutes to 240 minutes.
- Acoustic systems ranging from STC 36 to STC 76.
- Panel dimensions of 250 mm wide, in lengths up to 9.3 metres.
- Panels that weigh (nominally) 10.2kg per lineal metre.
- Panels available in galvanised or colour steel.

Typical Applications are:

- Dividing and boundary walls for sheds, factories and warehouses.
- Cinema walls.
- Intertenancy walls for apartments, terraced housing, hotels and retirement complexes.
- Lift shaft and duct walls.
- Acoustic barriers.

Due to its unique composition, KOROK® provides exceptional fire resistance over a long period of time.

However, to achieve the stated fire resistance ratings, it is critically important to adhere strictly to the design, installation and construction details otherwise the fire resistance rating may be degraded.

KOROK® panels have been tested and appraised by the Building Research Association of New Zealand (BRANZ). In some cases, a fire resistance rating has been based on an appraisal from the same organisation.

Where specific acoustic control performance is required, KOROK® can provide a number of proven, acoustic-rated wall systems, or can assist in developing a fully customised solution.

## CONTENTS

<b>INTRODUCTION</b>	<b>1</b>	Client feedback.....	4
Acoustic performance.....	1	Product highlights.....	5
Fire performance.....	1	<b>KOROK® SYSTEMS SUMMARY TABLE</b>	<b>6</b>
100% reusable, minimum waste.....	1	Table 1 - Fire rated systems.....	6
Project portfolio.....	2	Table 2 - Acoustic rated systems.....	7
Companies using KOROK®.....	2	K51 - KOROK® 51 mm Panel.....	8
Industrial and retail applications.....	3	FS1 - 60min fire rated system.....	9
Lift shafts, ducts and stairs.....	3	FS2 - 120min fire rated system.....	10
Intertenancy applications.....	3	FS3 - 180min fire rated system.....	11
Steel building and sheds.....	4		

## CONTENTS (cont.)

EX1 - 120min FRR external wall system .....	12	Handling and storage .....	38
KIT01 - 60/60/60 .....	13	Strippable film .....	38
KIT06 - 120/120/120 .....	14	Cleaning .....	38
KIT06A - 120/120/60 .....	15	On site handling .....	38
NCS2 - STC58 duct and shaft wall system .....	16	Installation .....	38
NCS3 - STC59 apartment intertenancy acoustic rated system .....	17	Maintenance .....	39
NCS4 - STC76 cinema system .....	18	Material safety data sheet .....	39
<b>VERTICAL INSTALLATION</b>	<b>19</b>	Specification .....	39
Cutting panels .....	21	Warranty .....	39
Last panel .....	22	Disclaimer .....	39
Screw placement .....	23	Beware of substitutions .....	39
Table 3 - Screw placement vertical installation .....	23	Liability .....	39
C-track .....	23	Is this publication current? .....	39
Sealant placement .....	24	<b>PANEL PROPERTIES</b>	<b>40</b>
Final check .....	25	KOROK® panels .....	40
Head track protection .....	26	Loading combinations .....	40
Deflection c-track details .....	26	General design notes .....	40
<b>HORIZONTAL INSTALLATION</b>	<b>27</b>	References .....	40
Cutting panels .....	30	Manufacturers documents .....	40
Last panel .....	31	Standards .....	40
Screw placement .....	32	<b>KOROK® PANEL PROPERTIES: 78 MM</b>	<b>41</b>
Table 4 - Screw placement horizontal installation .....	32	Vertical span walls .....	41
C-track .....	32	Horizontal span walls .....	41
Deflection c-track details .....	32	Thermal resistance .....	41
Sealant placement .....	33	Definitions .....	41
Final check .....	33	Use of tables .....	41
<b>CHANGING PANEL ORIENTATION</b>	<b>34</b>	Deflection c-track details .....	41
Mix of horizontal and vertical panels .....	34	Supporting structures .....	41
Changing panel direction .....	34	Installation note .....	41
<b>GENERAL CORNERS AND JUNCTIONS</b>	<b>35</b>	Table 5 - Shear strength per fastener for the following connections .....	42
Vertical wall 90° corner detail .....	35	Table 6 - Horizontal span .....	42
T-junctions .....	35	Table 7 - Vertical span .....	42
<b>UNSUPPORTED DOOR OPENINGS</b>	<b>36</b>	<b>KOROK® PANEL PROPERTIES: 51 MM</b>	<b>43</b>
Doors in KOROK® systems .....	36	Vertical span walls .....	43
<b>INSTALLATION INFORMATION</b>	<b>37</b>	Horizontal span walls .....	43
Doorways and windows .....	37	Definitions .....	43
Penetrations .....	37	Use of tables .....	43
Plumbing and electrical services .....	37	Deflection c-track details .....	43
Shelf loads .....	37	Supporting structures .....	43
Fixing accessories .....	37	Installation note .....	43
External wall installation .....	37	Table 8 - Shear strength per fastener for the following connections .....	44
New Zealand Building Code (NZBC) compliance .....	37	Table 9 - Horizontal span .....	44
Deflection c-track details .....	37	Table 10 - Vertical span .....	44
Quality control .....	38	<b>KOROK® COMPONENTS SUMMARY</b>	<b>45</b>
Design guidelines .....	38	<b>TABLE 11 - KOROK® FASTENERS SPACINGS</b>	<b>46</b>
Limitations .....	38	<b>SUSTAINABILITY</b>	<b>48</b>
Transport .....	38		

# INTRODUCTION

## SUPERIOR FIRE AND ACOUSTIC PERFORMANCE WITH CLIP-TOGETHER SIMPLICITY

- BRANZ appraised.
- Roll formed galvanised steel or colour steel outer shell.
- Lightweight with aerated concrete core.
- Fire ratings up to -/240/240.
- Acoustic ratings up to STC 76.
- Panels interlock with clip-together simplicity for rapid installation.
- Can be dismantled and reassembled to accommodate changing requirements.
- Can be installed horizontally or vertically.

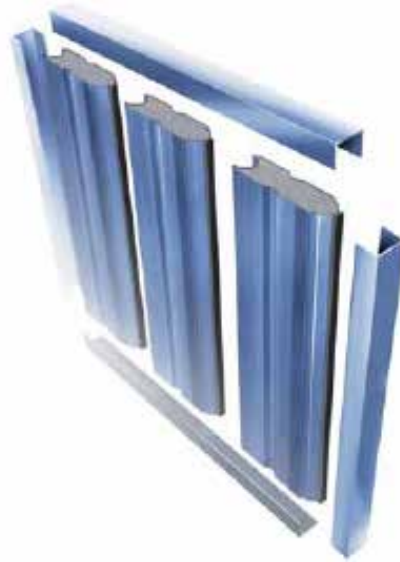

When acoustic and fire regulations demand a high performance, no-risk solution, KOROK® will exceed New Zealand Building Code requirements for internal and external non-load bearing walls simply and cost effectively.

Exceptionally strong yet lightweight, the interlocking panels can be easily erected by a small crew, making KOROK® much faster to install than conventional wall systems.

Construction using KOROK® also allows a building to be made weather resistant much earlier in the construction cycle allowing internal work and finishing to be started sooner.

### ACOUSTIC PERFORMANCE

KOROK®'s inherent mass and interlocking design gives it outstanding acoustic reduction properties making it highly suitable in buildings where acoustic performance is critical, such as cinemas, lecture theatres, apartments, recording studios and industrial/commercial intertenancy situations.

The unique interlocking design eliminates the risk of sound "leaks" between panels, and makes installation much faster and more simple than traditional systems.

### FIRE PERFORMANCE

KOROK® delivers proven two-way fire resistance over a long period of time. KOROK® has been tested and appraised by the Building Research Association of New Zealand (BRANZ).

### 100% REUSABLE, MINIMUM WASTE

KOROK® is manufactured in New Zealand and offers unique benefits in terms of sustainability and environmental performance:

- Walls can be reused by simply dismantling the panels and reinstalling them in another location.
- The raw components (steel and concrete) are 100% recyclable.
- Panels are custom manufactured to size, minimising waste at the factory and on the construction site.
- DECLARE - KOROK® has Declare Certification for our panels, the most accessed sustainability certification in the building industry <https://declare.living-future.org/products/korok-panel>. See page 48.



## PROJECT PORTFOLIO

Event Cinema, Tauranga Crossing  
 Sylvia Park, Auckland  
 La Residence De La Plage, Orewa  
 Christchurch Library  
 Outpatients, Christchurch Hospital  
 The Crossings, Christchurch  
 Auckland University Business School  
 Berkeley Cinemas, Botany Downs  
 Farmers Car Park, Christchurch  
 Grenada Business Park, Wellington  
 Henderson Film Studios, Auckland  
 Lumina Apartments, Auckland  
 Westfield Newmarket, Auckland  
 NZ Post Mail Centres (Auckland, Hamilton, Christchurch)  
 Precinct On Lorne, Auckland



## COMPANIES USING KOROK®

Classic Builders  
 Dominion Constructors  
 Federal Group  
 Fletcher Construction  
 Hawkins Construction  
 Haydn & Rollett Construction  
 Jasmex  
 Jennian Homes  
 Leighs Construction  
 LT McGuinness Ltd  
 Macrennie Construction  
 Morrison Architects  
 Naylor Love  
 Universal Homes  
 Warren and Mahoney  
 Watts & Hughes Construction



# INTRODUCTION

## INDUSTRIAL AND RETAIL APPLICATIONS

In factories, warehouses and bulk retail environments, KOROK® provides strong, solid separation walls that are secure and fire compliant with high acoustic insulating properties. In buildings where the interior layout may need to be reconfigured for future needs, KOROK® is especially versatile in that it can be easily dismantled and relocated.

Galvanised KOROK® has a highly reflective surface and when left unlined, can help create a brighter, safer working environment. Alternatively, KOROK® can be supplied in a range of colour steel paint finishes.



## INTERTENANCY APPLICATIONS

With traditional intertenancy wall systems, it is often difficult to achieve reliable on-site fire and acoustic performance due to the complex nature of the installation requirements. The clip-together simplicity of KOROK® greatly reduces installation complexity and minimizes the risk of sound “leaks” or discrepancies in on site acoustic performance.

With a baseline performance of STC 56 and a fire rating up to FRR –/240/120, KOROK® intertenancy systems for multi-unit residential projects exceed all Building Code requirements for both fire and acoustic control.

KOROK® is a popular choice for partition walls in factories, workshops and other commercial developments where there are multiple tenants and noise is an issue.

## LIFT SHAFTS, DUCTS AND STAIRS

KOROK® offers significant advantages over traditional construction. Because it can be installed from one side only, there is no requirement to construct scaffolding inside the shaft, greatly reducing construction time and costs. Unlike traditional systems, KOROK® can be installed before the structure is watertight and also helps prevent water from entering the building through open shafts.



## STEEL BUILDING AND SHEDS

KOROK® is especially efficient and economical when used for fire-rated separation and boundary walls in steel buildings, sheds and similar structures.

Installation can generally be managed by a three-person team and no cranes are required on site.

The floor slab does not have to be specially engineered to accommodate the additional weight associated with traditional tilt slab or other similar construction techniques, leading to significant cost savings.



KOROK® can be manufactured with a colour steel paint finish.

## CLIENT FEEDBACK

### IGNITE ARCHITECTS

*Berkeley Cinemas*

"KOROK® is far superior to normal construction for a theatre. It took out the possibility of there being a flaw by removing a lot of the human error factor. It cut out between six and eight weeks' worth of construction time."

– Jeremy Craig, Architect

### FLETCHER CONSTRUCTION

*Auckland University Business School*

"We got two months advantage on the building programme by going to KOROK®. It's been a test case for Fletcher Building as we look towards introducing KOROK® into our other building projects."

– Andrew Rolfe, Site Manager

### SPANTECH BUILDINGS

*Taupo Motorpark*

"We were looking for a cost-effective alternative to precast panels. KOROK® is much quicker and shortened the project by two to three weeks on an eight-week project. It was easy to do and the acoustic rating is brilliant."

– Marc Osborne

### MAINZEAL CONSTRUCTION

*Scene 3 Apartments*

"The acoustic qualities and fire qualities were quite a selling point and were well over code requirements. KOROK® construction saved us a lot of time, hassle and risk. The system is so robust and reliable."

– John Williams, Project Manager

## PRODUCT HIGHLIGHTS



Exceptionally strong yet lightweight, the interlocking panels can be easily erected by a small crew, making KOROK® much faster to install than conventional wall systems.



KOROK® can be installed horizontally or vertically and can be disassembled, relocated or reconfigured to suit changing space requirements.



KOROK® can provide an effective sound barrier in any situation where noise is a problem.



KOROK® panels are custom manufactured to order in lengths up to 9.3 metres. This system of manufacture minimises waste both at the factory and on the construction site.



# KOROK® SYSTEMS SUMMARY TABLE

TABLE 1 - FIRE RATED SYSTEMS

SPEC. CODE	STC	FRR	WALL THICKNESS*	FRAME	CAVITY	SYSTEM SUMMARY	PAGE
K51	36	-/60/60	51 mm	N/A	N/A	KOROK® 51 mm panels (600 Kg/m <sup>3</sup> density) KOROK® metal fire flashing is installed to the top C-track <b>OR</b> 13 mm GIB Fyrelite® or equivalent x 120 mm strip with sealant is fixed at 250 mm centres top and bottom, using 6g x 32 mm drywall screws.	8
FS1	36	-/120/60	78 mm	N/A	N/A	KOROK® 78 mm panels with no linings attached	9
FS2	36	-/120/120	78 mm	N/A	N/A	KOROK® 78 mm panels with no linings attached. KOROK® Fire Flashing is fixed on one side of the top KOROK® C-track <b>OR</b> 13 mm GIB Fyrelite® or equivalent 120 mm strip with sealant is fixed at 250 mm centres top and bottom, using 6g x 32 mm drywall screws.	10
FS3	40	-/180/180	104 mm	N/A	N/A	KOROK® 78 mm panels with 13 mm GIB Fyrelite® or equivalent on both sides	11
EX1	36	-/120/120	78 mm	N/A	N/A	KOROK® 78 mm panels with no linings attached	12

\*Nominal thickness

When used as a fire rated system refer to KOROK® panel Properties section for maximum unsupported spans.

Due to its unique composition, KOROK® provides exceptional fire resistance over a long period of time.

To achieve the stated fire resistance ratings, it is critically important to adhere strictly to the design, installation and construction details in this manual otherwise the fire resistance rating may be degraded.

KOROK® fire rated wall panels have been tested and appraised by the Building Research Association of New Zealand (BRANZ). In some cases, a fire resistance rating has been based on opinion from the same organisation.

**IMPORTANT:** In order to satisfy the requirements of New Zealand Building Code (Clause C6) relating to "structural stability during fire", designers must ensure that KOROK® elements are supported by primary elements that have at least the same fire rating as the KOROK® system that is used, unless the primary structure lies outside the fire cell.

## DEFLECTION C-TRACK DETAILS

Dead and live loads can cause significant deflection in some structures.

KOROK® can provide deflection C-track details where deflection loadings are considered.

Contact your KOROK® representative on 0800 773 777 for a solution specific to your project.

# KOROK® SYSTEMS SUMMARY TABLE

TABLE 2 - ACOUSTIC RATED SYSTEMS

SPEC. CODE	STC	FRR	WALL THICKNESS*	FRAME	CAVITY	SYSTEM SUMMARY	PAGE
KIT01	64	60/60/60	288mm	90mm steel or timber frame each side	Minimum 86mm overall between the framing. Framing not to touch KOROK® panel or fire flashing	KOROK® 51mm panels (600 Kg/m <sup>3</sup> density) + 1 layer 10mm GIB® Standard plasterboard or equivalent each side  Acoustic insulation must be a minimum 90mm thick and have a minimum density of 12 Kg/m <sup>3</sup> .  KOROK® metal fire flashing is installed to the top C-track. KOROK® metal KIT flashing is installed to horizontal joints.	13
KIT06	65	120/120/120	315mm	90mm steel or timber frame each side	Minimum 108mm overall between the framing. Framing not to touch KOROK® panel or fire flashing	KOROK® 78mm panels (400 Kg/m <sup>3</sup> density) + 1 layer 10mm GIB® Standard plasterboard or equivalent each side  Acoustic insulation must be a minimum 90mm thick and have a minimum density of 12 Kg/m <sup>3</sup> .  KOROK® metal fire flashing is installed to the top C-track. KOROK® metal KIT flashing is installed to horizontal joints.	14
KIT06A	65	120/120/60	315mm	90mm steel or timber frame each side	Minimum 108mm overall between the framing. Framing not to touch KOROK® panel	KOROK® 78mm panels (400 Kg/m <sup>3</sup> density) + 1 layer 10mm GIB® Standard plasterboard or equivalent each side  Acoustic insulation must be a minimum 90mm thick and have a minimum density of 12 Kg/m <sup>3</sup> .	15
NCS2	58	-/120/120	175mm	64mm Steel stud	20mm	KOROK® 78 mm panels with a 20mm cavity, 64mm steel stud, R1.8 insulation and a layer of 13 mm GIB Noiseline®	16
NCS3	59	-/120/120	188mm	64mm Steel stud	20mm	KOROK® 78 mm panels with a 20mm cavity, 64mm steel stud, R1.8 insulation and a layer of 13 mm GIB Noiseline® on one side with a layer of 13 mm standard plasterboard on the other side	17
NCS4	76	-/120/120	600mm	N/A	444mm	2 parallel walls of KOROK® 78 mm panels (400 Kg/m <sup>3</sup> density) with a 444mm cavity and a layer of 90mm x 42kg/m <sup>2</sup> insulation attached to one internal face	15

\*Nominal thickness

When used as a fire rated system refer to KOROK® panel Properties section for maximum unsupported spans.

Due to its unique composition, KOROK® provides exceptional fire resistance over a long period of time. To achieve the stated fire resistance ratings, it is critically important to adhere strictly to the design, installation and construction details in this manual otherwise the fire resistance rating may be degraded. KOROK® fire rated wall panels have been tested and appraised by the Building Research Association of New Zealand (BRANZ). In some cases, a fire resistance rating has been based on opinion from the same organisation.

**IMPORTANT:** In order to satisfy the requirements of New Zealand Building Code (Clause C6) relating to "structural stability during fire", designers must ensure that KOROK® elements are supported by primary elements that have at least the same fire rating as the KOROK® system that is used, unless the primary structure lies outside the fire cell.

## DEFLECTION C-TRACK DETAILS

Dead and live loads can cause significant deflection in some structures. KOROK® can provide deflection C-track details where deflection loadings are considered. Contact your KOROK® representative on 0800 773 777 for a solution specific to your project.



# K51 - KOROK® 51 MM PANEL

SPEC. CODE	STC	FRR	WALL THICKNESS*	FRAME	CAVITY	SYSTEM SUMMARY
K51	36	-/60/60	51 mm	N/A	N/A	<p>KOROK® 51 mm panels (600 Kg/m<sup>3</sup> density)</p> <p>KOROK® metal fire flashing is installed to the top C-track</p> <p>OR</p> <p>13 mm GIB Fyreline® or equivalent x 120 mm strip with sealant is fixed at 250 mm centres top and bottom, using 6g x 32 mm drywall screws.</p>

\*Nominal thickness

## KOROK® PANEL

KOROK® 51 mm panels are located in KOROK® C-track 60 mm high x 51 mm wide x 1.15bmt. The KOROK® C-track is fixed to the structure at 400 mm centres max, and bedded on a 6mm bead of fire rated sealant.

## SEALANT

Beads of fire rated sealant are required around the perimeter of the KOROK® system. Refer to the installation section of this publication for more information on sealant application, and to the KOROK® Components Summary (page 45) for approved sealants.

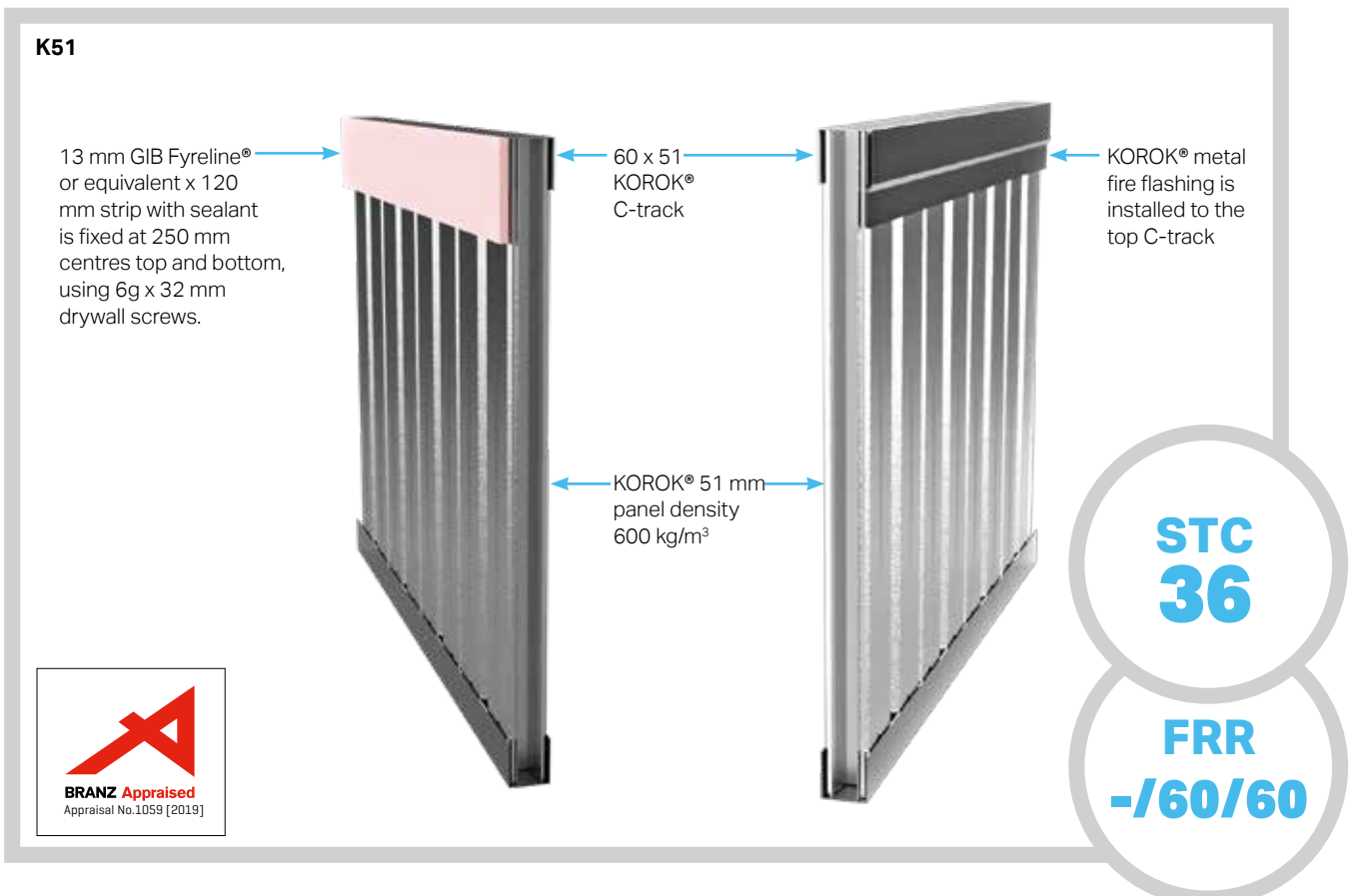

# FS1 - 60MIN FIRE RATED SYSTEM

SPEC. CODE	STC	FRR	WALL THICKNESS*	FRAME	CAVITY	SYSTEM SUMMARY
FS1	36	-/120/60	78 mm	N/A	N/A	KOROK® 78 mm panels with no linings attached

\*Nominal thickness

## KOROK® PANEL

KOROK® panels are 78 mm thick, located in KOROK® C-track 60 mm high x 80 mm wide x 1.15B.M.T.

KOROK® C-track is fixed to the supporting structure at a maximum of 400 mm centres bedded on a bead of fire-rated sealant.

## SEALANT

Beads of fire rated sealant are required around the perimeter of the KOROK® system. Refer to the installation section of this publication for more information on sealant application, and to the KOROK® Components Summary (page 45) for approved sealants.

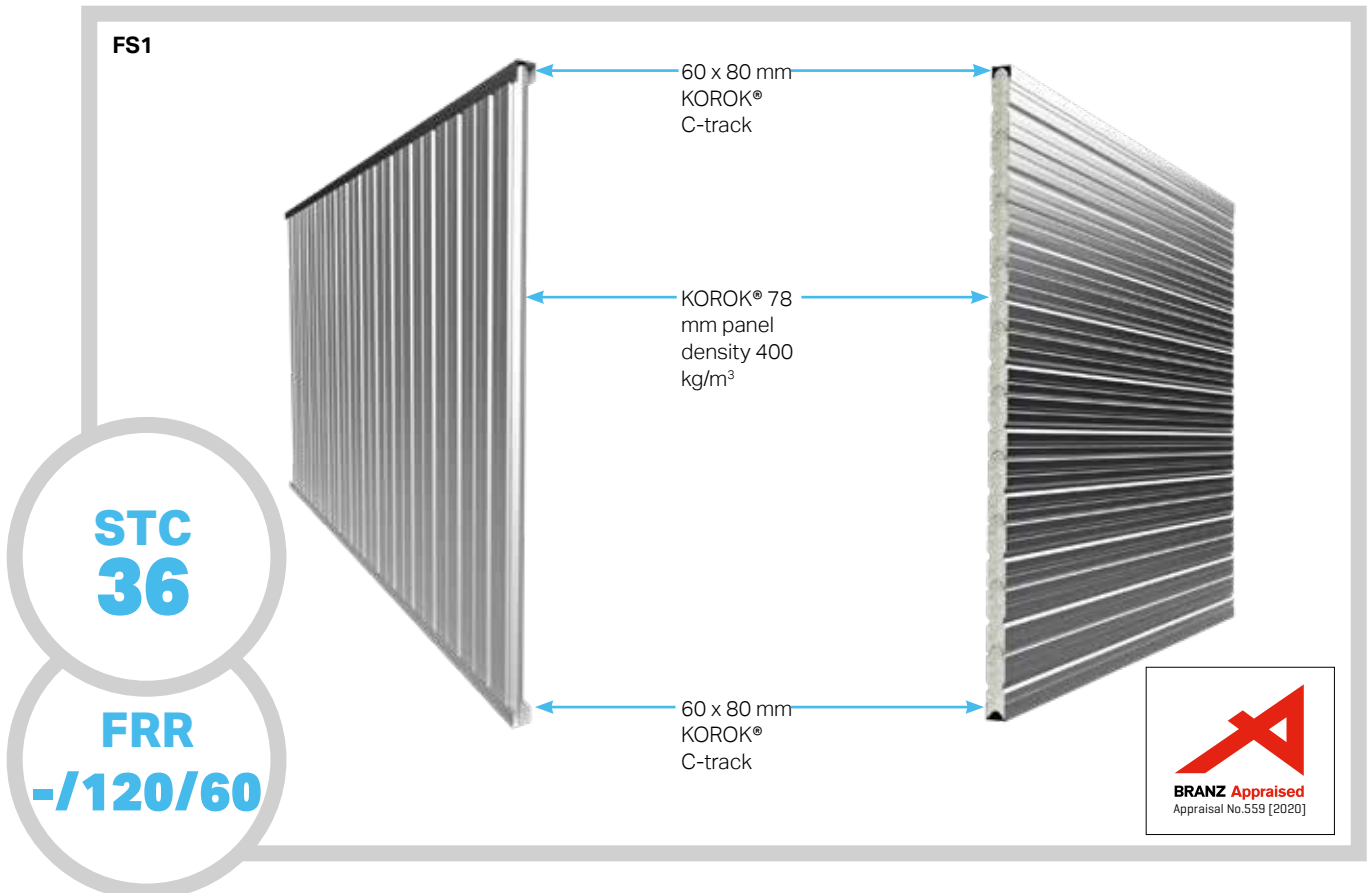

# FS2 - 120MIN FIRE RATED SYSTEM

SPEC. CODE	STC	FRR	WALL THICKNESS*	FRAME	CAVITY	SYSTEM SUMMARY
FS2	36	-/120/120	78 mm	N/A	N/A	KOROK® 78 mm panels with no linings attached. KOROK® Fire Flashing is fixed on one side of the top KOROK® C-track

\*Nominal thickness

## KOROK® PANEL

KOROK® panels are 78 mm thick, located in KOROK® C-track 60 mm high x 80 mm wide x 1.15B.M.T.

KOROK® C-track is fixed to the supporting structure at a maximum of 400 mm centres bedded on a bead of fire-rated sealant.

## SEALANT

Beads of fire rated sealant are required around the perimeter of the KOROK® system. Refer to the installation section of this publication for more information on sealant application, and to the KOROK® Components Summary (page 45) for approved sealants.

## KOROK® FIRE FLASHING

KOROK® fire flashing is fixed to the panels at 250 mm centres

OR

13 mm GIB Fyreline® or equivalent x 120 mm strip with sealant is fixed at 250 mm centres top and bottom, using 6g x 32 mm drywall screws.

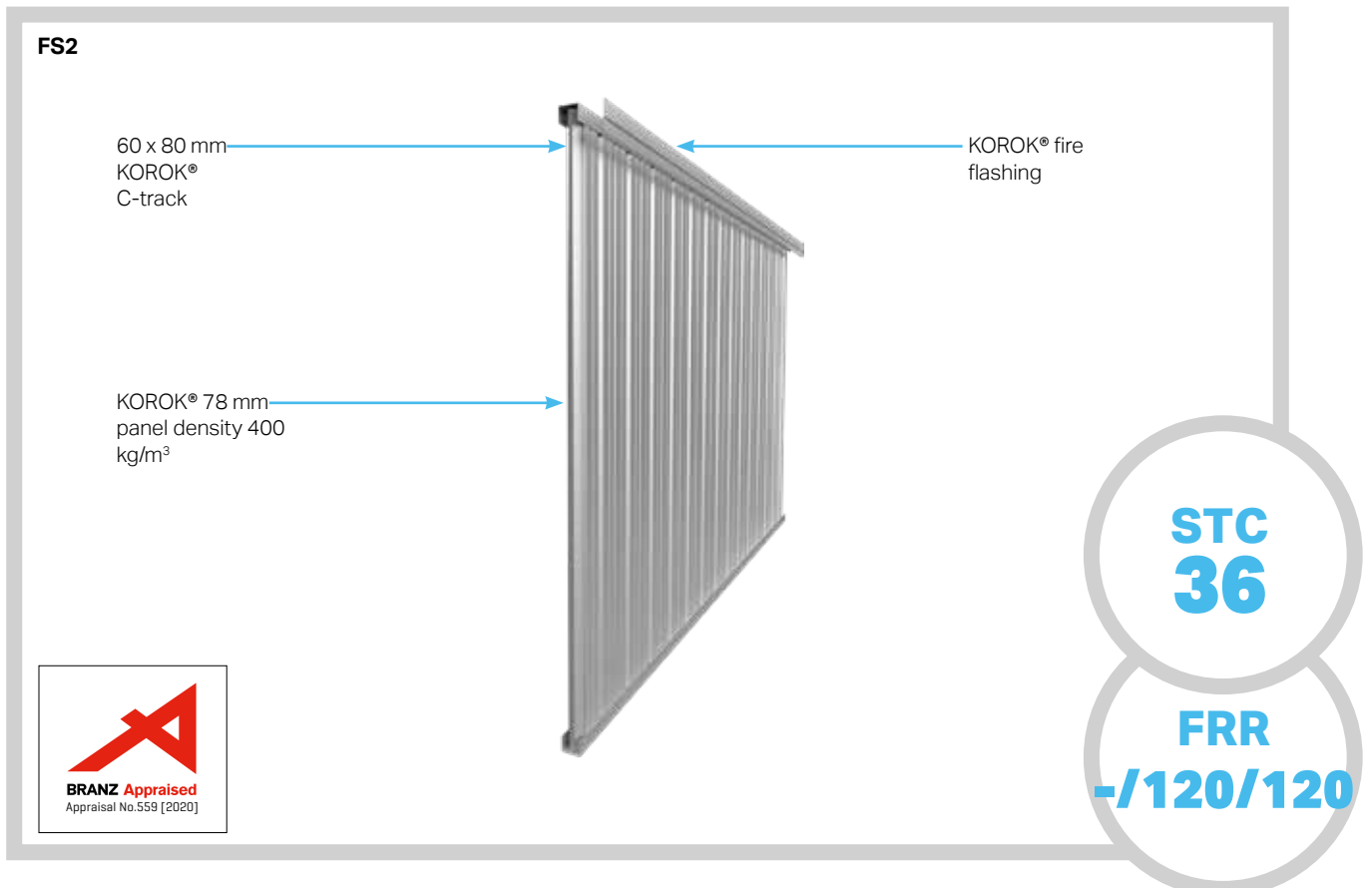

# FS3 - 180MIN FIRE RATED SYSTEM

SPEC. CODE	STC	FRR	WALL THICKNESS*	FRAME	CAVITY	SYSTEM SUMMARY
FS3	40	-/180/180	104 mm	N/A	N/A	KOROK® 78 mm panels with 13 mm GIB Fyreline® or equivalent on both sides

\*Nominal thickness

## KOROK® PANEL

KOROK® panels are 78 mm thick, located in KOROK® C-track 60 mm high x 80 mm wide x 1.15B.M.T.

KOROK® C-track is fixed to the supporting structure at a maximum of 400 mm centres bedded on a bead of fire-rated sealant.

## LINING

1 layer of 13 mm GIB Fyreline® or equivalent each side of the wall. Full height sheets shall be used where possible. Sheets shall be touch fitted. Offset joints on opposite sides of the wall by 600mm. Linings are fixed hard to floor.

Plasterboard linings are installed to the manufacturer's specification.

## JOINTING

All screw heads stopped and all sheet joints tape reinforced and stopped in accordance with the plasterboard manufacturers recommendations and specifications.

## SEALANT

Beads of fire rated sealant are required around the perimeter of the KOROK® system. Refer to the installation section of this publication for more information on sealant application, and to the KOROK® Components Summary (page 45) for approved sealants.

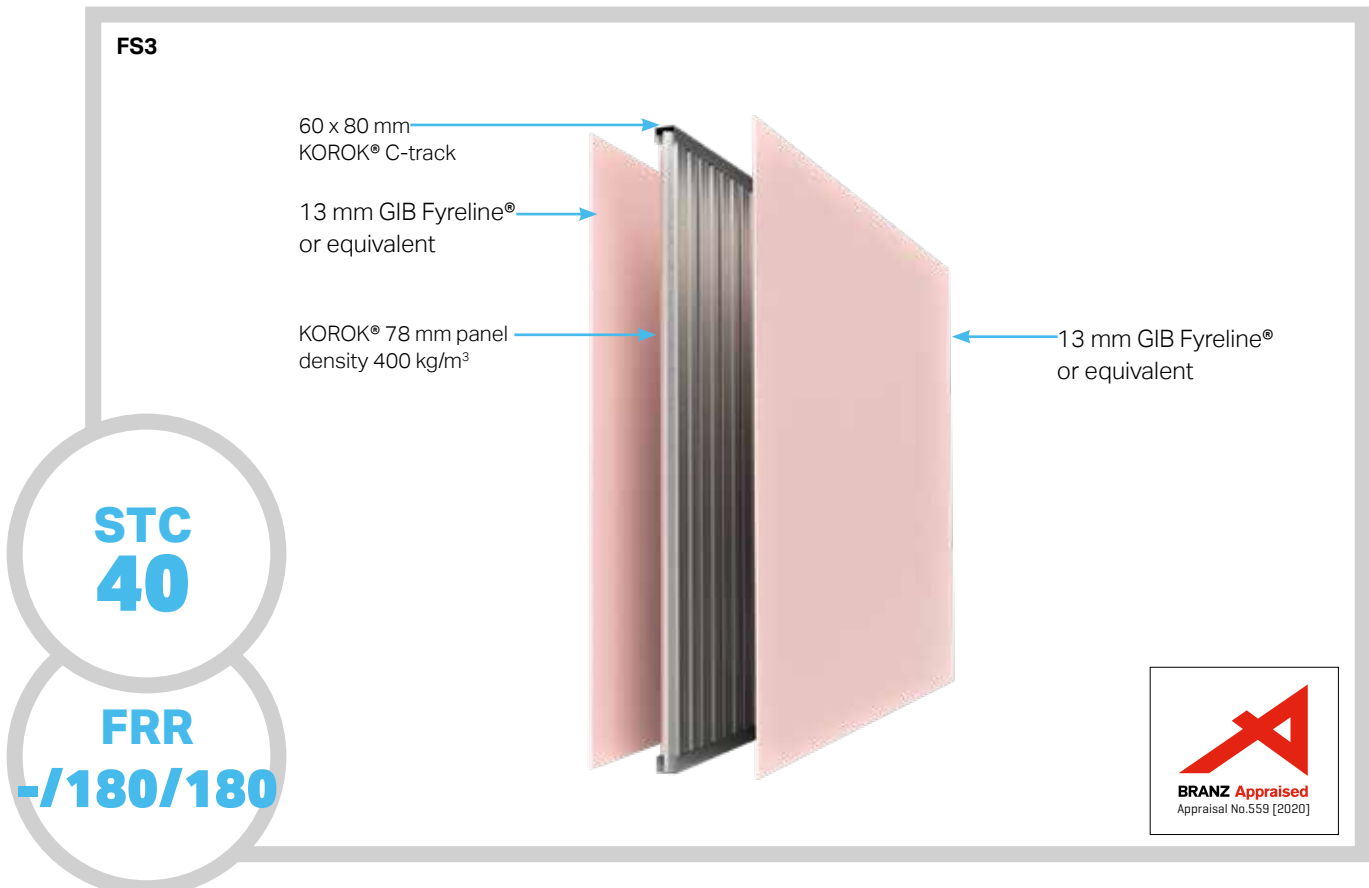

# EX1 - 120MIN FRR EXTERNAL WALL SYSTEM

SPEC. CODE	STC	FRR	WALL THICKNESS*	FRAME	CAVITY	SYSTEM SUMMARY
EX1	36	-/120/120	78 mm	N/A	N/A	KOROK® 78 mm Colorsteel® panels (400 Kg/m <sup>3</sup> density) with no linings attached

\*Nominal thickness

## KOROK® PANEL

KOROK® panels are 78 mm thick, located in KOROK® C-track 60 mm high x 80 mm wide x 1.15B.M.T. on the top and sides and Base Angle at the bottom.

## EX1

KOROK® System EX1 is an all-in-one wall solution for fire, acoustic and weather protection in external applications with no doors, windows or other penetrations.

The system comprises KOROK® 78 mm panels, with no linings attached. Standard KOROK® C-track is used around the perimeter of the wall, and KOROK® Base Angle at the bottom of the wall as shown in diagram below.

The standard system has a 120-minute fire rating and a acoustic rating of STC 36. However, fire ratings up to 240 minutes and acoustic ratings up to STC 76 can be achieved with specific design.

KOROK® panels for external use are pre-painted and can be supplied in a wide range of colours.

## SEALANT

Beads of fire rated sealant are required around the perimeter of the KOROK® system. Refer to the installation section of this publication for more information on sealant application, and to the KOROK® Components Summary (page 45) for approved sealants.

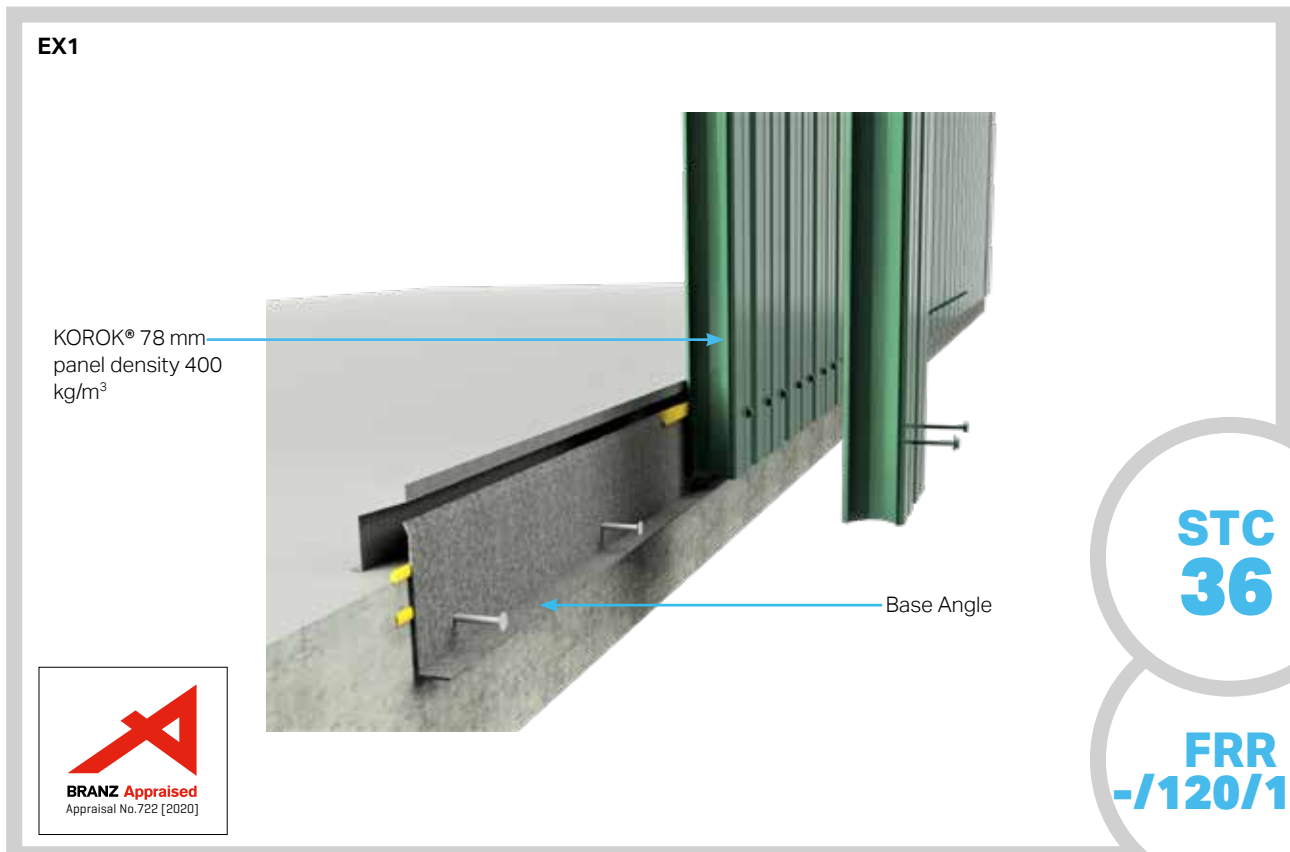

# KIT01 - 60/60/60

SPEC. CODE	STC	FRR	WALL THICKNESS*	FRAME	CAVITY	SYSTEM SUMMARY
KIT01	64	60/60/60	288mm	90mm steel or timber frame each side	Minimum 86mm overall between the framing Framing not to touch KOROK® panel or fire flashing	KOROK® 51mm panels (600 Kg/m <sup>3</sup> density) + 1 layer 10mm GIB® Standard plasterboard or equivalent each side Acoustic insulation must be a minimum 90mm thick and have a minimum density of 12 Kg/m <sup>3</sup> . KOROK® metal fire flashing is installed to the top C-track. KOROK® metal KIT flashing is installed to horizontal joints.
KIT01 modified	63	60/60/60	282mm	90mm steel or timber frame each side	Minimum 80mm overall between the framing Framing not to touch KOROK® panel or fire flashing	KOROK® 51mm panels (600 Kg/m <sup>3</sup> density) + 1 layer 10mm GIB® Standard plasterboard or equivalent each side Acoustic insulation must be a minimum 90mm thick and have a minimum density of 12 Kg/m <sup>3</sup> . KOROK® metal fire flashing is installed to the top C-track. KOROK® metal KIT flashing is installed to horizontal joints.

\*Nominal thickness

**KOROK® PANEL** KOROK® 51mm panels are located in KOROK® C-track 60mm high x 51mm wide x 1.15B.M.T. KOROK® panels must not exceed 12 metres in height.

**FRAMING** Frames must be designed to meet the requirements of NZBC Part B and consider the loading imposed on them by the KOROK® wall. Cavity must be 86mm overall. Framing not to touch KOROK® panel or fire flashing.

**ACOUSTIC INSULATION** Acoustic insulation can be either glass wool or semi-rigid polyester designed to be friction fitted into the wall cavity. The insulation must be a minimum 90mm thick and have a minimum density of 12 Kg/m<sup>3</sup> or equivalent.

**SUPPORT BRACKETS** KOROK® aluminium brackets are fixed to the panel and framing. Refer to the installation section of this manual for bracket spacing.

**LINING** Frames are lined with 1 layer of 10mm GIB® Standard plasterboard or equivalent each side of the wall. Joints must occur over framing. Plasterboard linings are installed to the manufacturer's specification.

**SEALANT** Beads of fire rated sealant are required around the perimeter of the KOROK® system. Refer to the installation section of this manual for more information on sealant application, and to the KOROK® Components Summary for approved sealants.

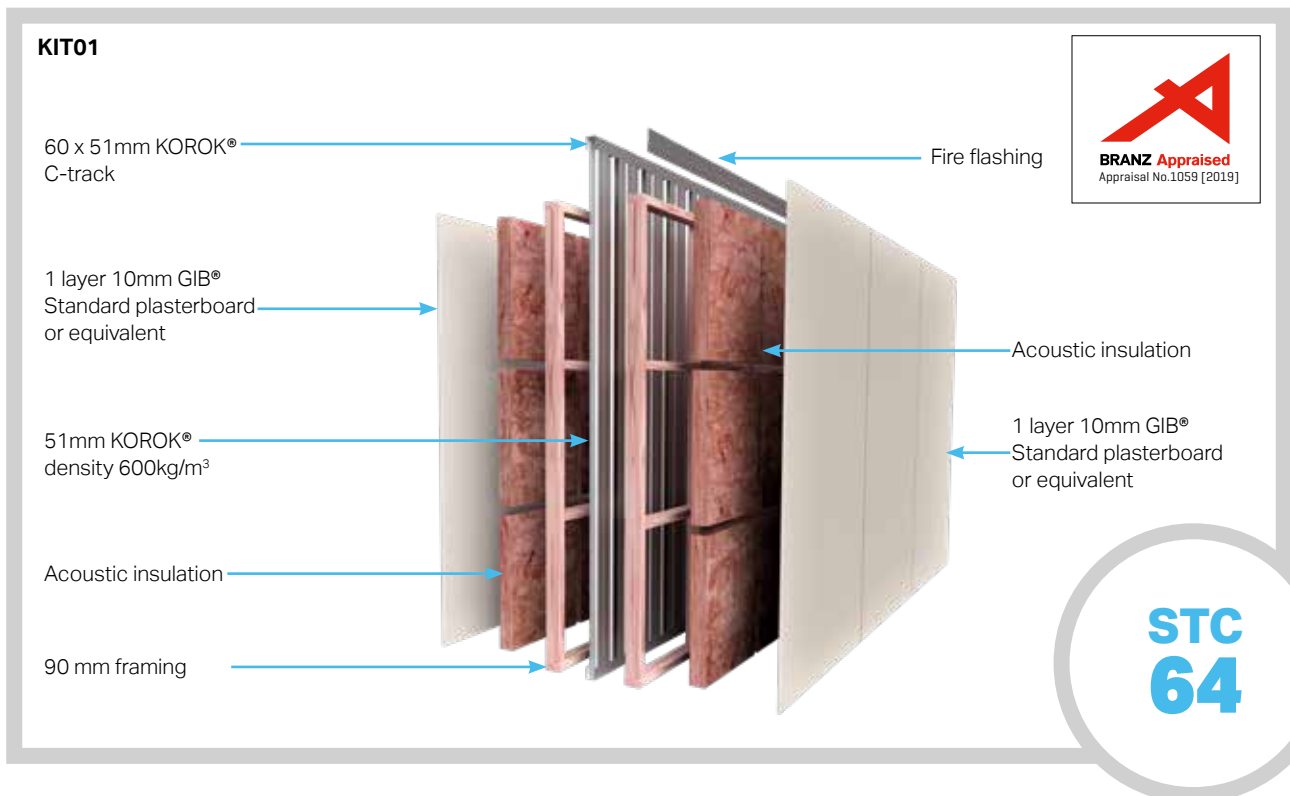



# KIT06 - 120/120/120

SPEC. CODE	STC	FRR	WALL THICKNESS*	FRAME	CAVITY	SYSTEM SUMMARY
KIT06	65	120/120/120	315mm	90mm steel or timber frame each side	Minimum 108mm overall between the framing. Framing not to touch KOROK® panel or fire flashing	<p>KOROK® 78mm panels (400 Kg/m<sup>3</sup> density) + 1 layer 10mm GIB® Standard plasterboard or equivalent each side</p> <p>Acoustic insulation must be a minimum 90mm thick and have a minimum density of 12 Kg/m<sup>3</sup>.</p> <p>KOROK® metal fire flashing is installed to the top C-track. KOROK® metal KIT flashing is installed to horizontal joints.</p>

\*Nominal thickness

## KOROK® PANEL

KOROK® 78mm panels are located in KOROK® C-track 60mm high x 80mm wide x 1.15B.M.T. KOROK® panels must not exceed 14 metres in height.

## FRAMING

Frames must be designed to meet the requirements of the NZBC Part B, taking into consideration the load imposed on them by the KOROK® wall.

Cavity must be 108mm overall. Framing not to touch KOROK® panel or fire flashing.

## ACOUSTIC INSULATION

Acoustic insulation can be either glass wool or semi-rigid polyester designed to be friction fitted into the wall cavity. The insulation must be a minimum 90mm thick and have a minimum density of 12 Kg/m<sup>3</sup> or equivalent.

## SUPPORT BRACKETS

KOROK® aluminium brackets are fixed to the panel and framing. Refer to the installation section of this manual for bracket spacing.

## LINING

Frames are lined with 1 layer of 10mm GIB® Standard plasterboard or equivalent each side of the wall. Joints must occur over framing.

Plasterboard linings are installed to the manufacturer's specification.

## SEALANT

Beads of fire rated sealant are required around the perimeter of the KOROK® system. Refer to the installation section of this manual for more information on sealant application, and to the KOROK® Components Summary for approved sealants.

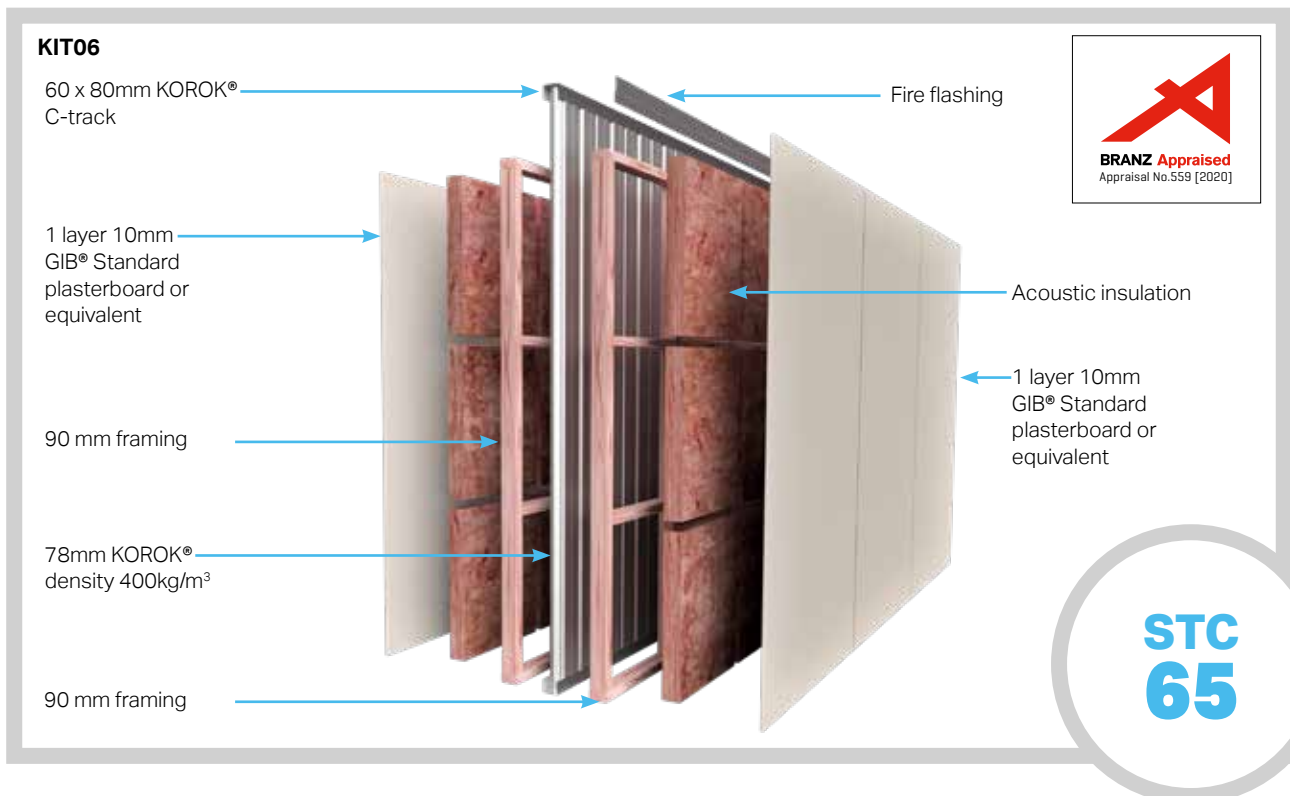

# KIT06A - 120/120/60

SPEC. CODE	STC	FRR	WALL THICKNESS*	FRAME	CAVITY	SYSTEM SUMMARY
KIT06A	65	120/120/60	315mm	90mm steel or timber frame each side	Minimum 108mm overall between the framing. Framing not to touch KOROK® panel	KOROK® 78mm panels (400 Kg/m <sup>3</sup> density) + 1 layer 10mm GIB® Standard plasterboard or equivalent each side  Acoustic insulation must be a minimum 90mm thick and have a minimum density of 12 Kg/m <sup>3</sup> .

\*Nominal thickness

## KOROK® PANEL

KOROK® 78mm panels are located in KOROK® C-track 60mm high x 80mm wide x 1.15B.M.T. KOROK® panels must not exceed 14 metres in height.

## FRAMING

Frames must be designed to meet the requirements of NZBC Part B and consider the loading imposed on them by the KOROK® wall.

Cavity must be 108mm overall. Framing not to touch KOROK® panel.

## ACOUSTIC INSULATION

Acoustic insulation can be either glass wool or semi-rigid polyester designed to be friction fitted into the wall cavity. The insulation must be a minimum 90mm thick and have a minimum density of 12 Kg/m<sup>3</sup> or equivalent.

## SUPPORT BRACKETS

KOROK® aluminium brackets are fixed to the panel and framing. Refer to the installation section of this manual for bracket spacing.

## LINING

Frames are lined with 1 layer of 10mm GIB® Standard plasterboard or equivalent each side of the wall. Joints must occur over framing.

Plasterboard linings are installed to the manufacturer's specification.

## SEALANT

Beads of fire rated sealant are required around the perimeter of the KOROK® system. Refer to the installation section of this manual for more information on sealant application, and to the KOROK® Components Summary for approved sealants.

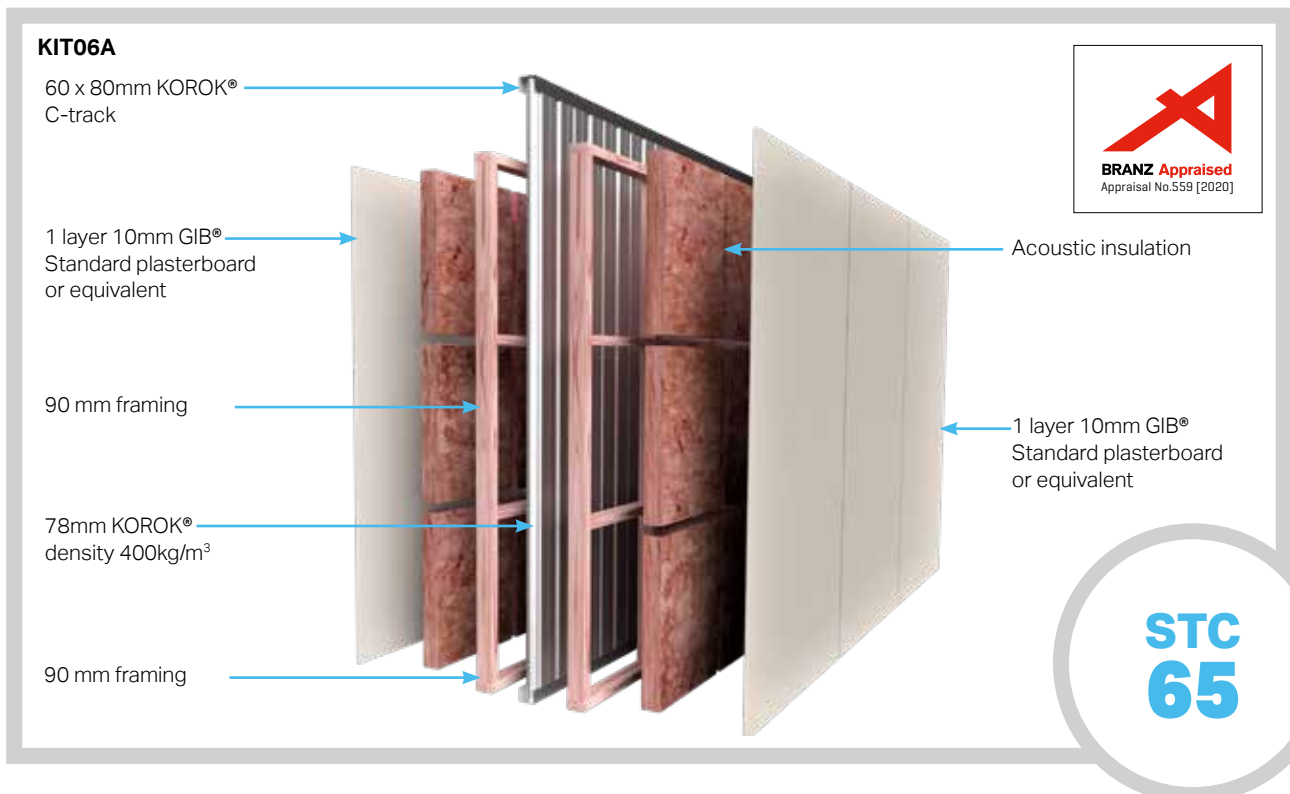

# NCS2 - STC58 DUCT AND SHAFT WALL SYSTEM

SPEC. CODE	STC	FRR	WALL THICKNESS*	FRAME	CAVITY	SYSTEM SUMMARY
NCS2	58	-/120/120	175mm	64mm Steel stud one side	20mm	KOROK® 78 mm panels + 1 layer 13 mm GIB Noiseline® or plasterboard of equivalent nominal thickness and density, one side

\*Nominal thickness

## KOROK® PANEL

KOROK® panels are 78 mm thick, located in KOROK® C-track 60 mm high x 80 mm wide x 1.15B.M.T.

KOROK® C-track is fixed at a maximum of 400 mm centres bedded on a bead of fire-rated sealant.

## FRAMING

Frames must be designed to meet the requirements of the NZBC Part B, taking into consideration the load imposed on them by the KOROK® wall.

Allow a minimum 20mm gap between the framing and the KOROK® panel.

## ACOUSTIC INSULATION

Acoustic insulation must be either Greenstuf Sound Solution® Plus 75 or Pink Batts R 1.8 or insulation of an equivalent nominal thickness and density.

## LINING

Frames are lined with 1 layer of 13 mm GIB Noiseline® or plasterboard of equivalent nominal thickness and density.

Plasterboard linings are installed to the manufacturer's specification.

## JOINTING

All fastener heads stopped and all sheet joints tape reinforced and stopped in accordance with the manufacturers publication.

## SEALANT

Beads of fire rated sealant are required around the perimeter of the KOROK® system. Refer to the installation section of this publication for more information on sealant application, and to the KOROK® Components Summary (page 45) for approved sealants.

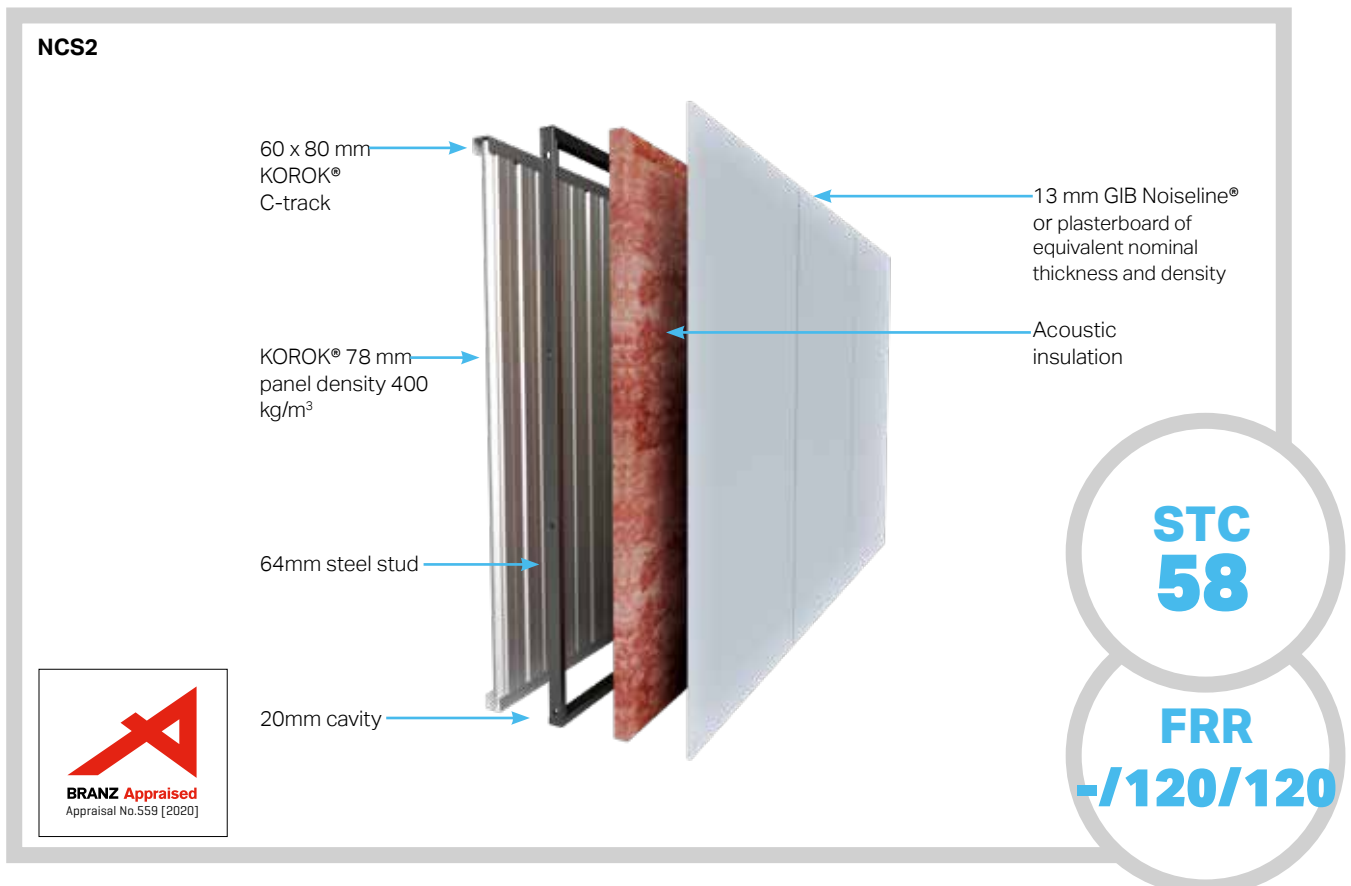

# NCS3 - STC59 APARTMENT INTERTENANCY ACOUSTIC RATED SYSTEM

SPEC. CODE	STC	FRR	WALL THICKNESS*	FRAME	CAVITY	SYSTEM SUMMARY
NCS3	59	-/120/120	188mm	64mm Steel stud one side	20mm	KOROK® 78 mm panels + 1 layer 13 mm GIB Noiseline® or plasterboard of equivalent nominal thickness and density one side + 1 layer 13 mm GIB® Standard or plasterboard of equivalent nominal thickness and density other side

\*Nominal thickness

## KOROK® PANEL

KOROK® panels are 78 mm thick, located in KOROK® C-track 60 mm high x 80 mm wide x 1.15B.M.T. C-track is fixed at a maximum of 400 mm centres bedded on a bead of fire-rated sealant.

## FRAMING

Frames are 64mm x 34mm x 0.55B.M.T. steel studs, friction fitted into C-Section tracks 64mm x 30mm x 0.55B.M.T.

Framing must be installed as per the manufacturer's instructions.

## ACOUSTIC INSULATION

Acoustic insulation must be either Greenstuf Sound Solution® Plus 75 or Pink Batts R 1.8 or insulation of an equivalent nominal thickness and density.

## LINING

Frame is lined with 1 layer of 13 mm GIB® Standard or plasterboard of equivalent nominal thickness and density on one side and one layer of 13 mm GIB Noiseline® or plasterboard of equivalent nominal thickness and density on the other, fixed vertically with joints over framing one side and direct fixed the other. All plasterboard linings must be fixed in accordance with the manufacturer's fixing instructions.

## SEALANT

Beads of fire rated sealant are required around the perimeter of the KOROK® system. Refer to the installation section of this publication for more information on sealant application, and to the KOROK® Components Summary (page 45) for approved sealants.

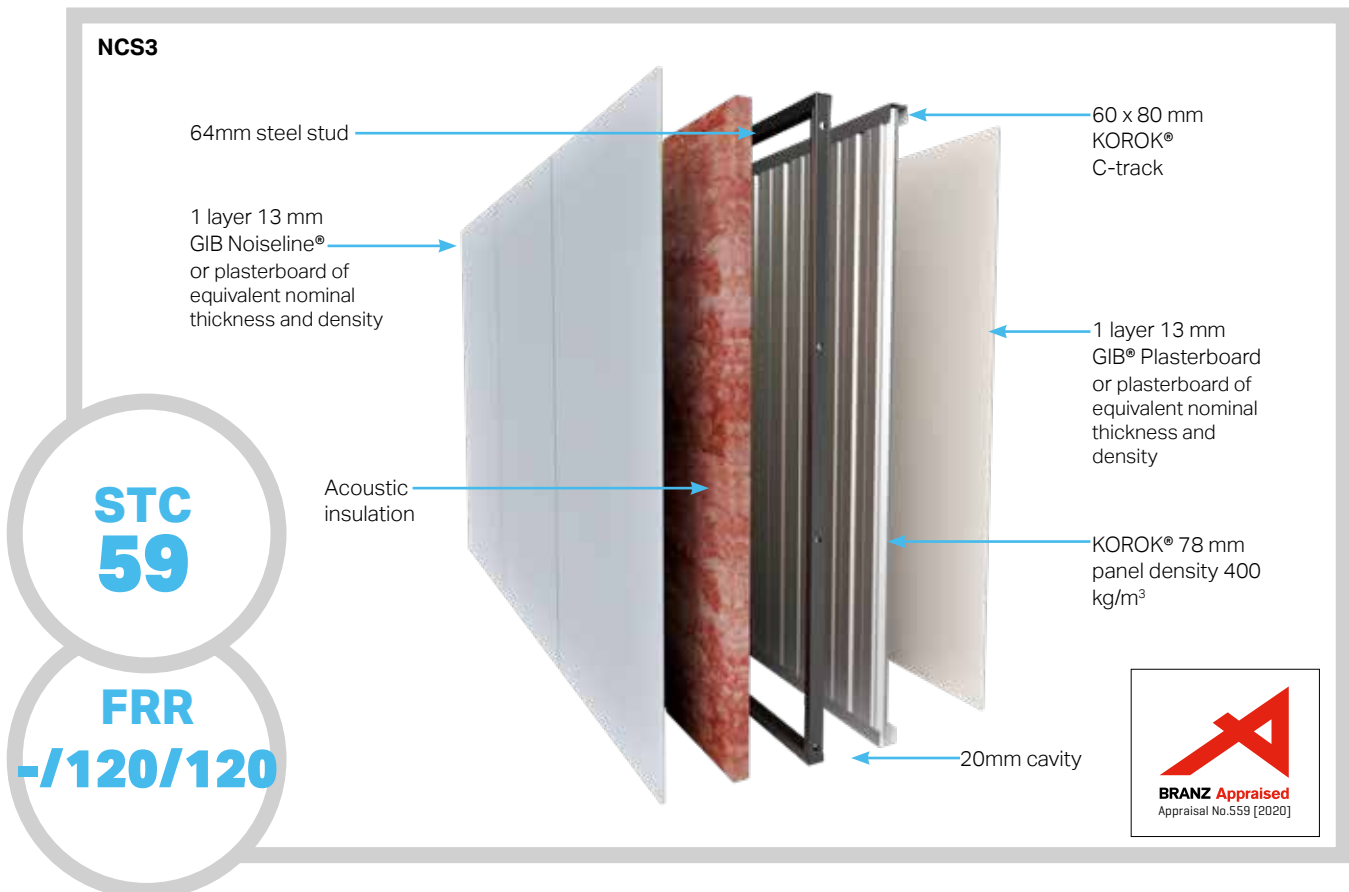

# NCS4 - STC76 CINEMA SYSTEM

SPEC. CODE	STC	FRR	WALL THICKNESS*	FRAME	CAVITY	SYSTEM SUMMARY
NCS4	76	-/120/120	600mm	N/A	444mm	2 parallel walls made up of KOROK® 78 mm panels with a 444mm cavity, and 1 layer of 90mm x 42kg/m <sup>3</sup> insulation attached to one internal face

\*Nominal thickness

## KOROK® PANEL

KOROK® panels are 78 mm thick, located in KOROK® C-track 60 mm high x 80 mm wide x 1.15B.M.T.

KOROK® C-track is fixed to the supporting structure at a maximum of 400 mm centres bedded on a bead of fire-rated sealant.

## SEALANT

Beads of fire rated sealant are required around the perimeter of the KOROK® system. Refer to the installation section of this publication for more information on sealant application, and to the KOROK® Components Summary (page 45) for approved sealants.

## ACOUSTIC INSULATION

1 layer of 90mm x 42kg/m<sup>3</sup> insulation or equivalent attached to one internal face.

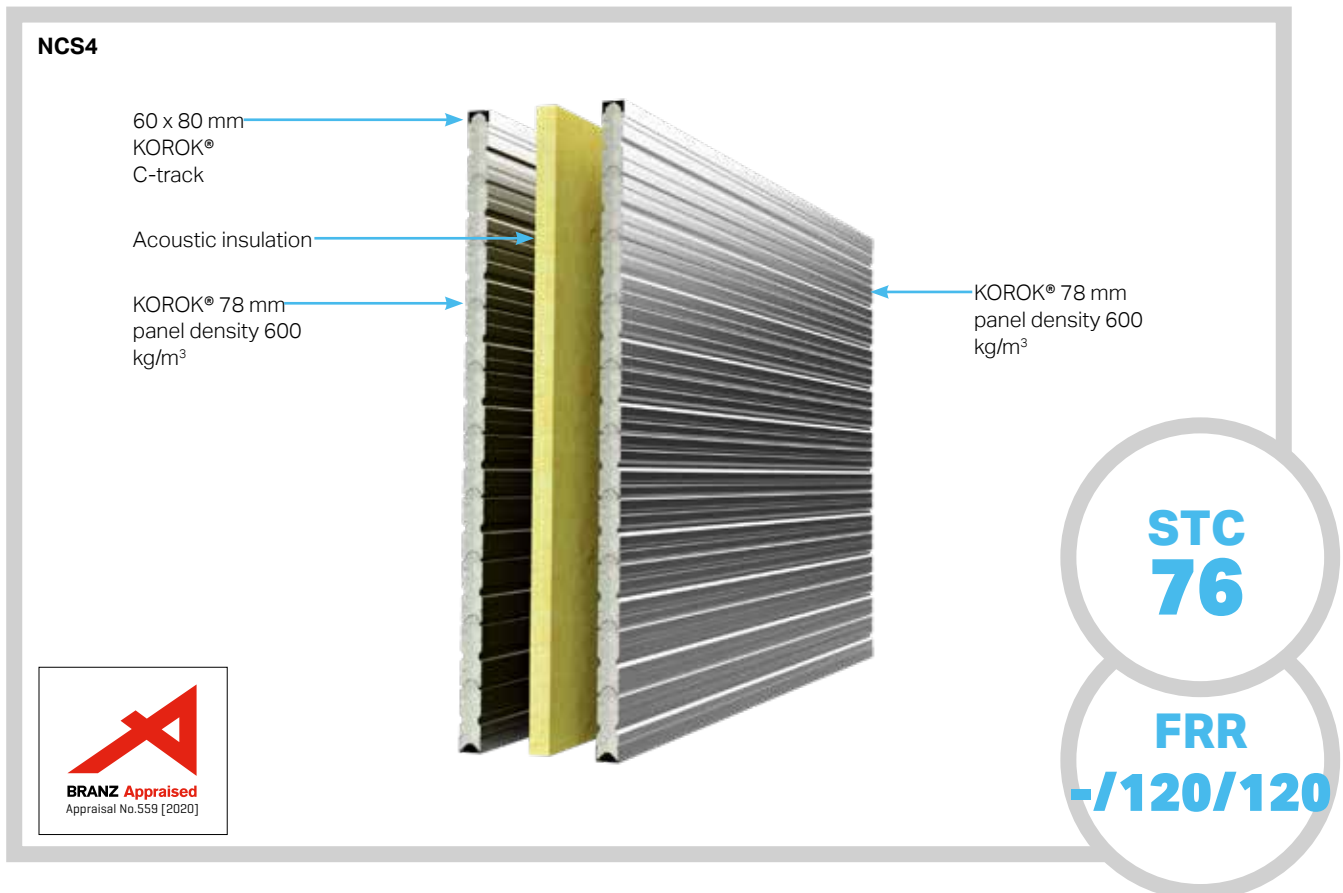

## VERTICAL INSTALLATION

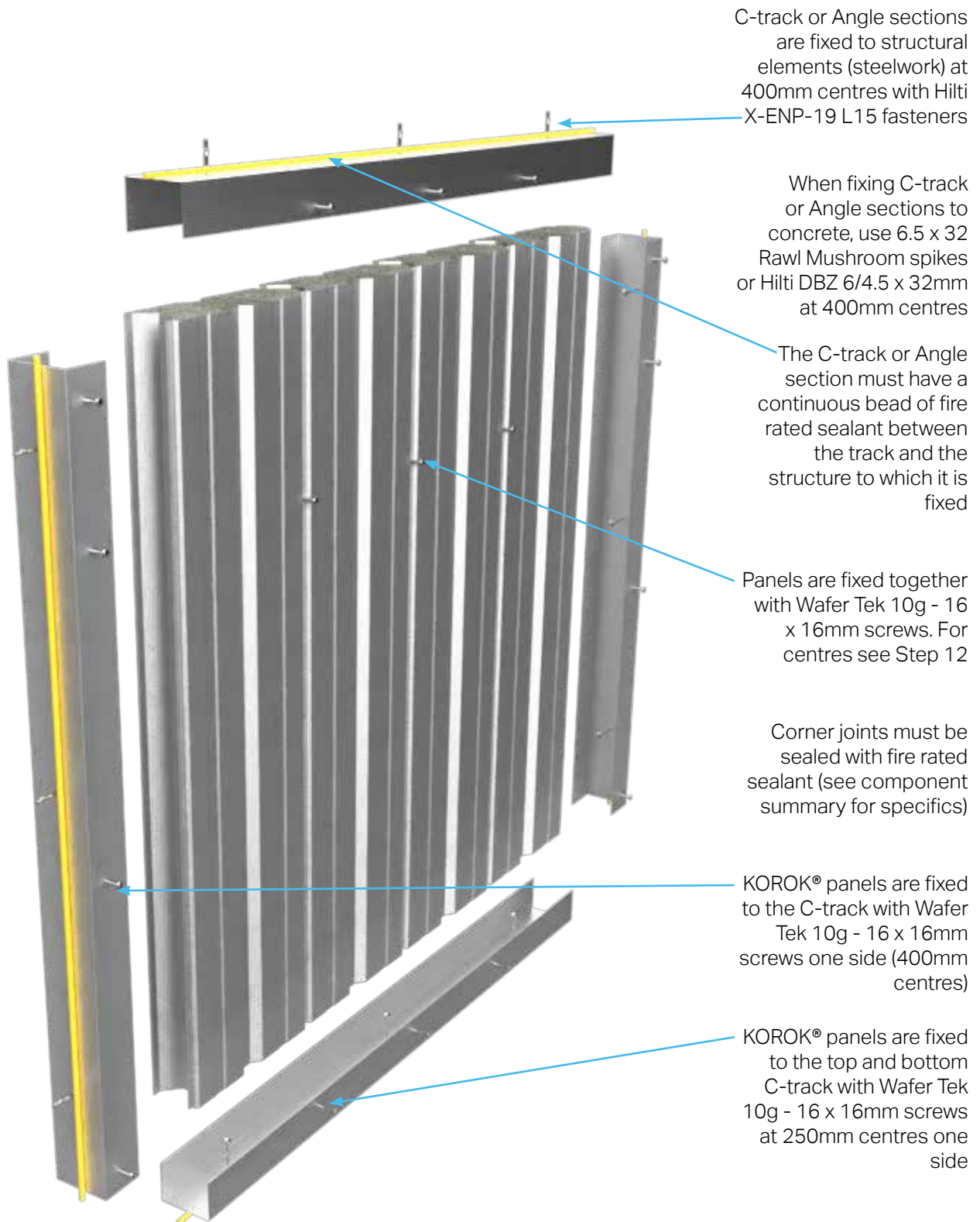

## VERTICAL INSTALLATION

**1** Vertical installation of the KOROK® panels requires the C-track to be fixed to the supporting structure, e.g. walls, columns, portals, soffits and slabs.

**Plan your setout.**



**2** To ensure the C-track is sealed to the structure, a continuous bead of fire rated sealant is run around the perimeter before the C-track or Angle sections are laid and fixed.

Or the sealant can be applied directly to the C-track before fixing in place.



**3** Using a masonry drill bit, pre-drill the C-track at 400 mm centres.

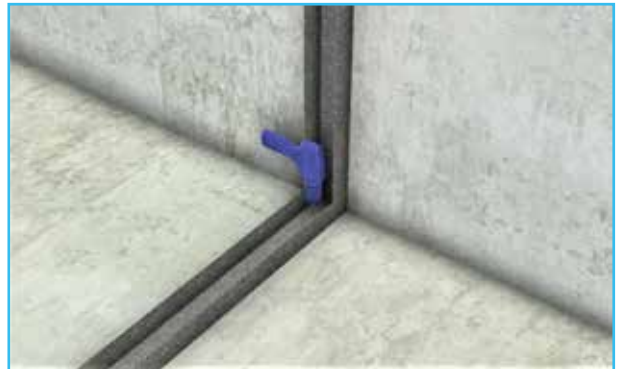

**4** Then use the fixings to secure the C-track.



## VERTICAL INSTALLATION

**5** If the surrounding surface is uneven or if you're not sure you have a good seal, add a continuous bead of sealant around the perimeter of the C-track where it contacts the surrounding surface.



**6** KOROK® panels must be cut 20 mm shorter than the structural opening measurement to allow for fitting.

*Where panels are supplied with protective film, pull back 300mm of the film at each end of the panels before placing the panels in the C-track.*

Ensure that the first panel is plumbed vertical after fitting into the C-track. Screw fix the panel into place to the C-track.

Subsequent panels are placed in a tilt and snap action.

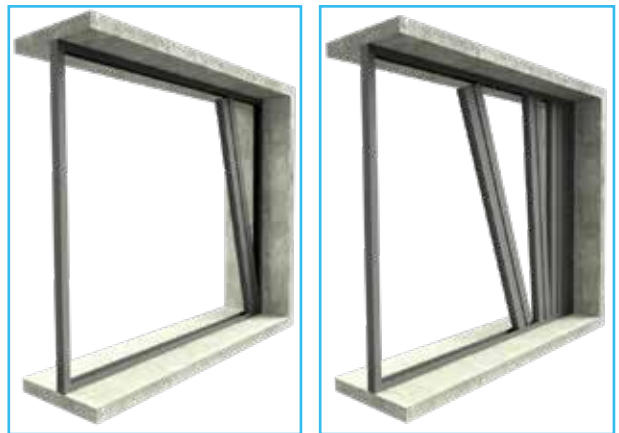

**7** Ensure the tongue and groove are fully locked to maintain the fire and acoustic performance. Remove strippable film at the end of each day's work.

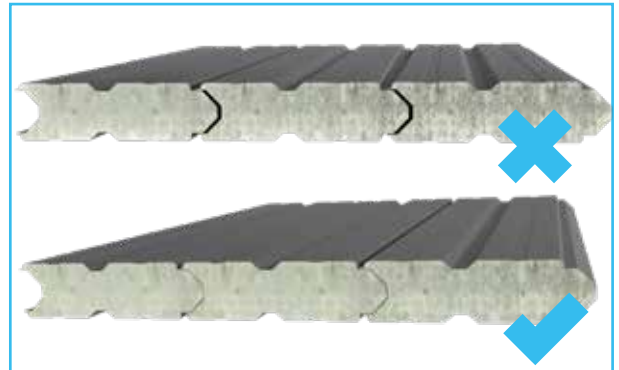

### CUTTING PANELS

**8** KOROK® panels can be cut to length and width using a radial saw with dust extraction. Diamond cutting discs are recommended for radial saws.

Where KOROK® panels are trimmed to width, the cut edge of the panel is fitted into the C-track and so is always the last panel abutting the wall or column. The panel is then sealed and fixed in position as usual.

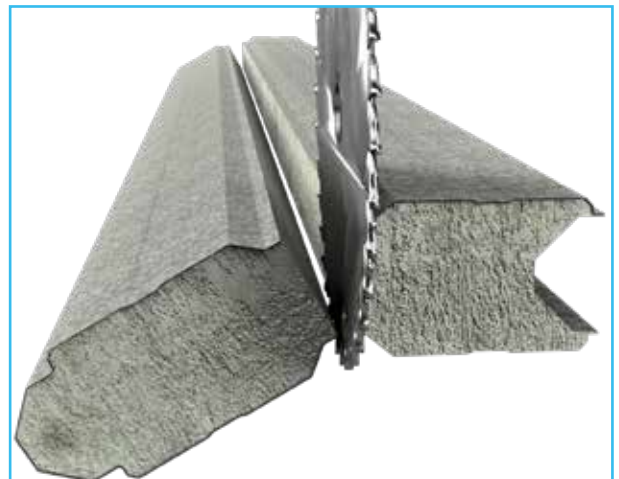



## VERTICAL INSTALLATION

### LAST PANEL

**9** Stop short of the end vertical KOROK® C-track by approximately 1 metre and cut out a 600mm Angle section from the top and bottom C-track.

**Plan ahead and make an allowance for a 50mm overlap onto the panels installed prior to the last remaining two panels.**

**10** Cut your end panel (the last panel) ensuring that a distance of 500mm remains between panels for the last two panels to be squeezed into position.

**11** Once the final two panels are in position, simply replace the Angle and fix to panels. Screw the C-track and Angle sections to the panels in the normal fashion.

**11A** When using 51 mm KOROK® panels seal the 3 close-off panel joints with fire rated sealant to one side.

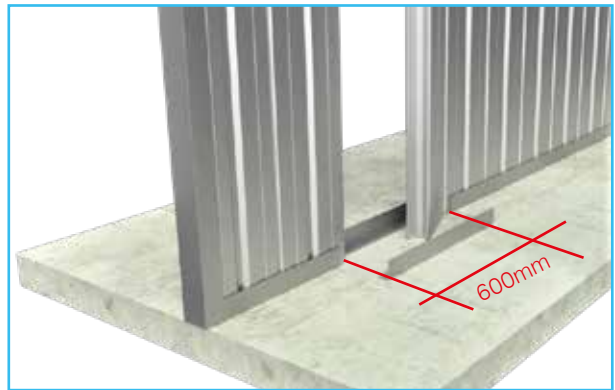

# VERTICAL INSTALLATION

## SCREW PLACEMENT

**12** Panels must be screwed together into every panel joint as per the vertical centres in **Table 3**.

**TABLE 3 - SCREW PLACEMENT VERTICAL INSTALLATION**

Panel Thickness	Wall Height	Maximum Centres	Sides	Placements/Notes
78 mm	0 to 9m	1000mm	One	

When used as a fire rated system refer to KOROK® panel Properties section for maximum unsupported spans.

## C-TRACK

C-track is fixed to the KOROK® panels at 400 mm centres on one side on the vertical C-track, and 250 mm centres on one side on the horizontal C-track.

At corners where two lengths of KOROK® C-track intersect, the two pieces must be fixed to each other with one or more Wafer Tek 10g - 16 x 16 mm screws.

## DEFLECTION C-TRACK DETAILS

Dead and live loads can cause significant deflection in some structures.

KOROK® can provide deflection C-track details where deflection loadings are considered.

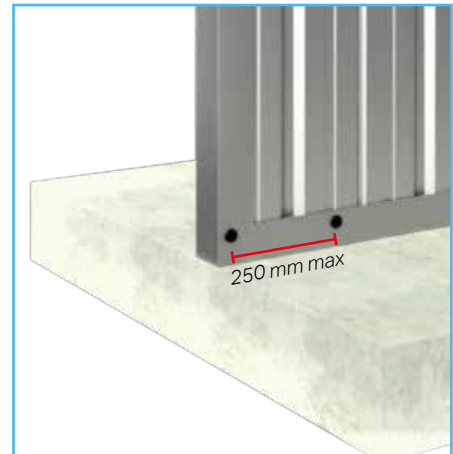

## VERTICAL INSTALLATION

### SEALANT PLACEMENT

**13** Remove any remaining plastic film and then apply a continuous bead of fire rated sealant between the KOROK® C-track and the KOROK® panels as indicated by the yellow line.



**14** Fire rated sealant details for top and sides.

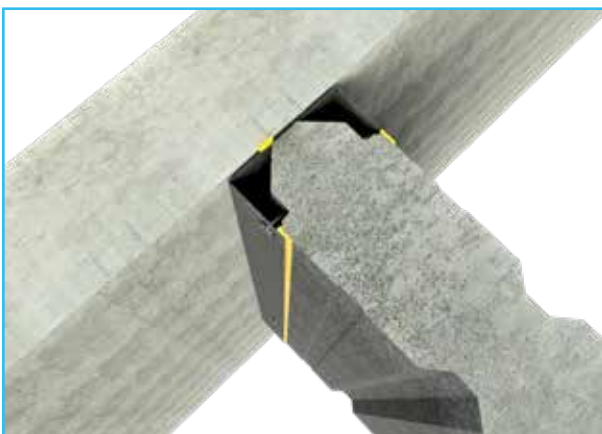
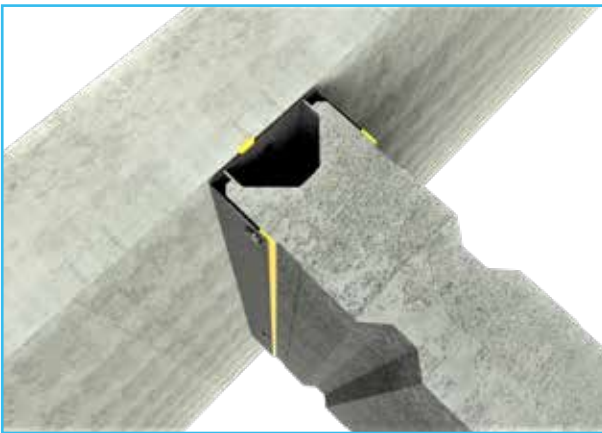

---

## VERTICAL INSTALLATION

**15** Using Angle as an alternative to C-track.



### FINAL CHECK

At the completion of the job and at the finish of each day's work, it is essential that the completed area be thoroughly cleaned of all swarf, rivet stems, nails, drillings and screws etc. normally associated with the installation of metal KOROK® panels. Remove any remaining strippable film, check all fixings are correctly installed, all fire and acoustic sealant is applied correctly.

# VERTICAL INSTALLATION

## HEAD TRACK PROTECTION

### 13 mm GIB Fyreline® PROTECTED HEAD TRACK

13 mm GIB Fyreline® or equivalent x 120 mm strip with sealant is fixed at 250 mm centres top and bottom, using 6g x 32 mm drywall screws.

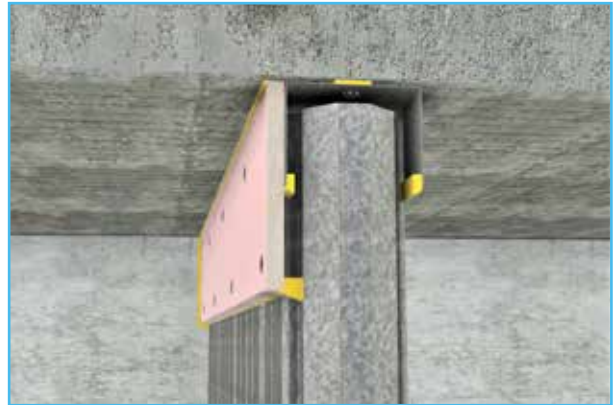

### METAL FLASHING PROTECTED HEAD TRACK

KOROK® fire flashing is fixed to the panels at 250 mm centres, using Wafer Tek 10g - 16 x 16 mm screws.

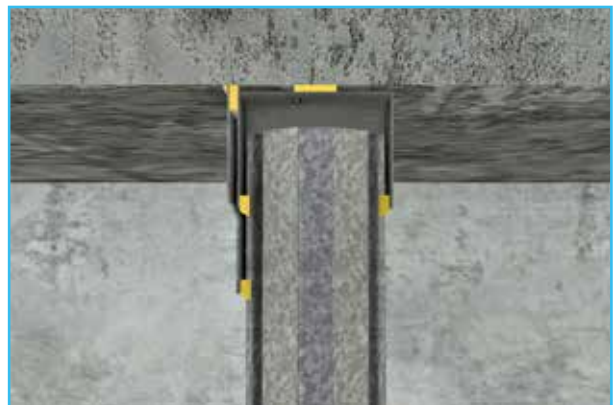

## DEFLECTION C-TRACK DETAILS

Dead and live loads can cause significant deflection in some structures.

KOROK® can provide deflection C-track details where deflection loadings are considered.

Contact your KOROK® representative on 0800 773 777 for a solution specific to your project.

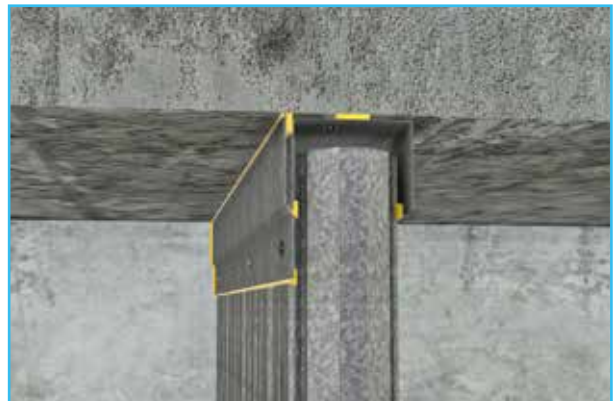

# HORIZONTAL INSTALLATION

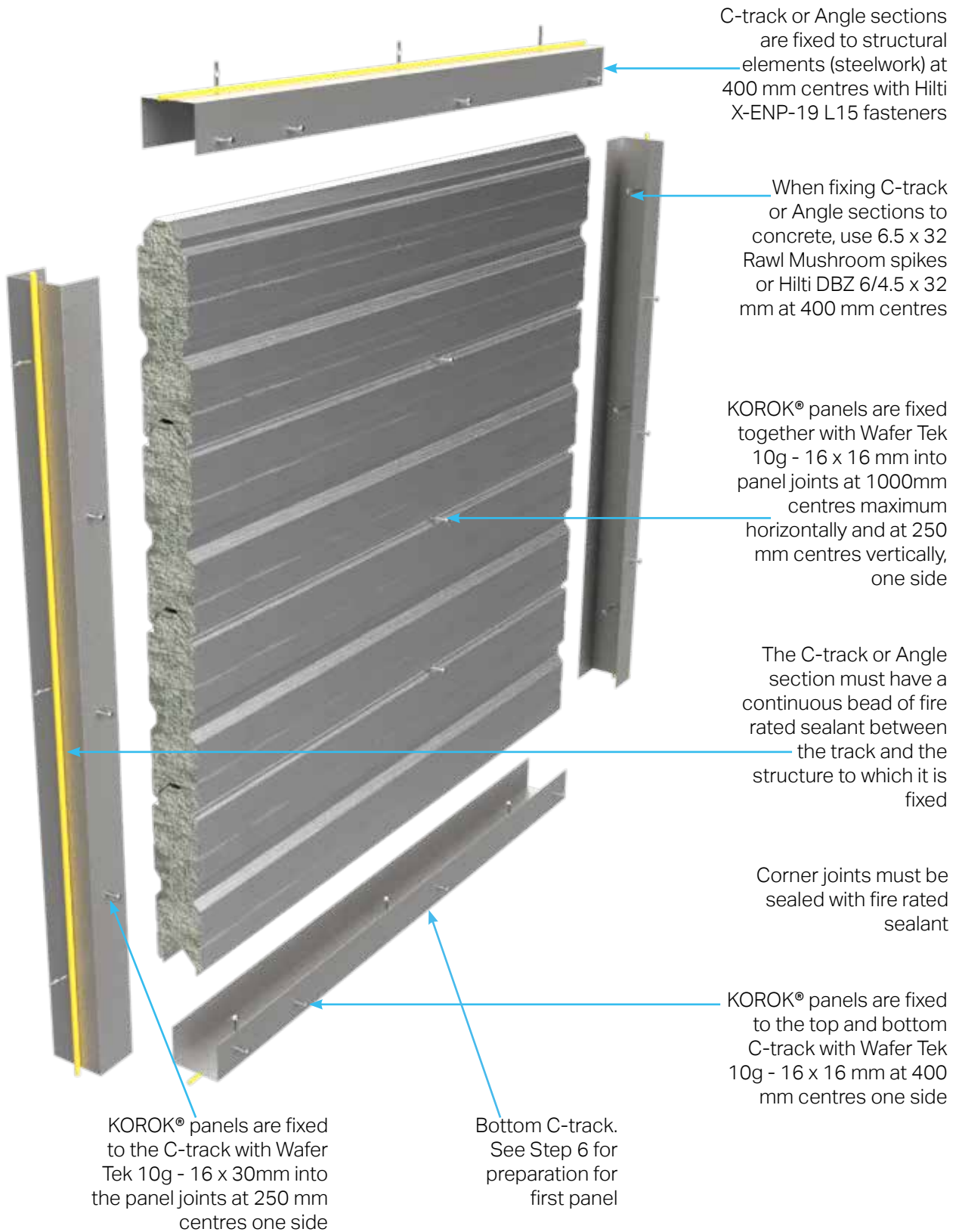

## HORIZONTAL INSTALLATION

**1** Horizontal Installation of the KOROK® panels requires the C-track to be fixed to the supporting structure, e.g. walls, columns, portals etc.

Plan your setout.

The top of the last vertical C-track must be cropped as per Step 10 prior to installation, to allow the top and last horizontal panel to be installed.



**2** To ensure the C-track is sealed to the structure, a continuous bead of fire rated sealant is run around the perimeter before the C-track or Angle sections are laid and fixed.

Or the sealant can be applied directly to the C-track before fixing in place.

The soffit track will generally be two Angles. See Last Panel details starting at Step 10.



**3** Using a masonry drill bit, pre-drill the C-track at 400 mm centres.



**4** Then use the fixings to secure the C-track.



## HORIZONTAL INSTALLATION

**5** If the surrounding surface is uneven or if you're not sure you have a good seal, add a continuous bead of sealant around the perimeter of the C-track where it contacts the surrounding surface.



**6** For horizontal installs where the wall width is greater than 5.0m OR where the load is transferred to the ground (e.g. 4-sided plant room), grout or a panel nose must be used in the bottom C-track.

**6.1** Grout is poured into the bottom C-track just prior to the installation of the KOROK® panels. This forms a bearing surface for the female end of the panel. The cementitious grout must be non-shrink high performance (Hilti® CM651-48 or similar).

Fill the C-track to a depth of 25-30mm. Any overflow when the panel is placed in the C-track must be wiped off immediately.

ENSURE THE FIRST PANEL IS LEVEL AFTER FITTING INTO THE TRACK AND GROUT AND FIX OFF.

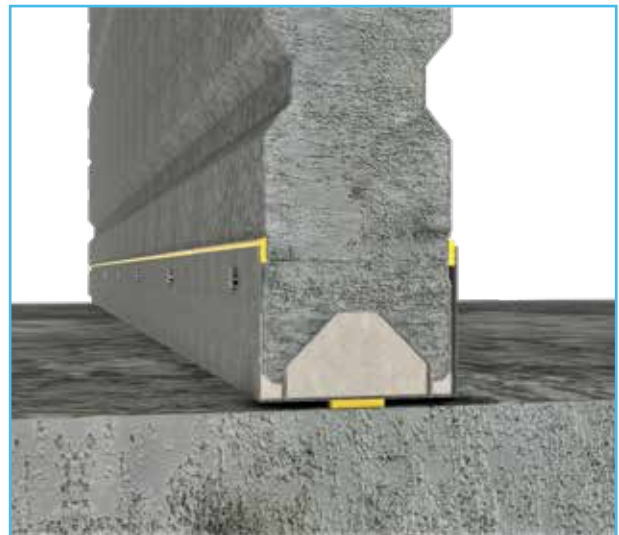

**OR**

**6.2** Alternatively the male nose of the top panel can be cut off and placed in the female end of the bottom panel to provide the same support.

ENSURE THE FIRST PANEL IS LEVEL AFTER FITTING INTO THE TRACK AND FIX OFF.

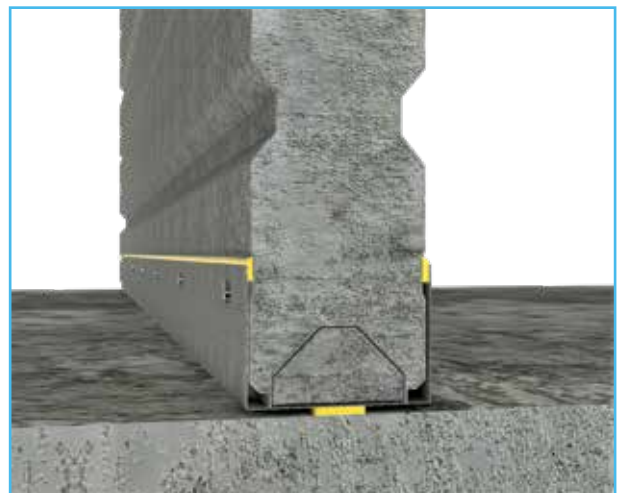



## HORIZONTAL INSTALLATION

**7** KOROK® panels must be cut 30mm shorter than the structural opening measurement to allow for fitting.

*Where panels are supplied with protective film, pull back 300mm of the film at each end of the panels before placing the panels in the C-track.*

Ensure that the first panel is level after fitting into the C-track. Screw fix the first panel into place to the C-track before installing the next panel.

Subsequent panels are placed in a tilt and snap action.

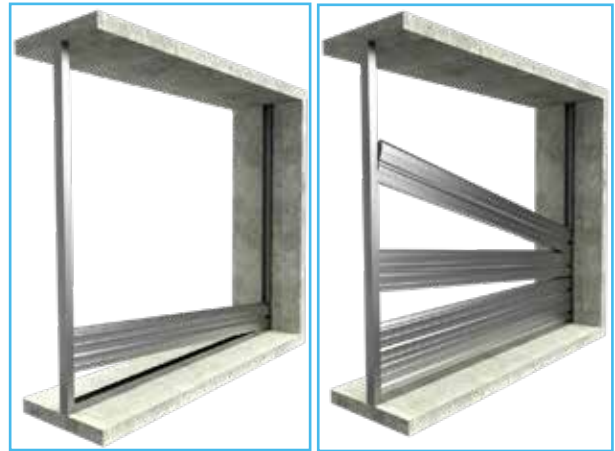

**8** Ensure the panels are clicked together correctly to maintain the fire and acoustic performance. Remove strippable film at the end of each day's work.



### CUTTING PANELS

**9** KOROK® panels can be cut to length and width using a radial saw with dust extraction. Diamond cutting discs are recommended for radial saws.

Where KOROK® panels are trimmed to width, the cut edge of the panel is fitted into the C-track and so is always the last panel abutting the floor or soffit. The panel is then sealed and fixed in position as usual.

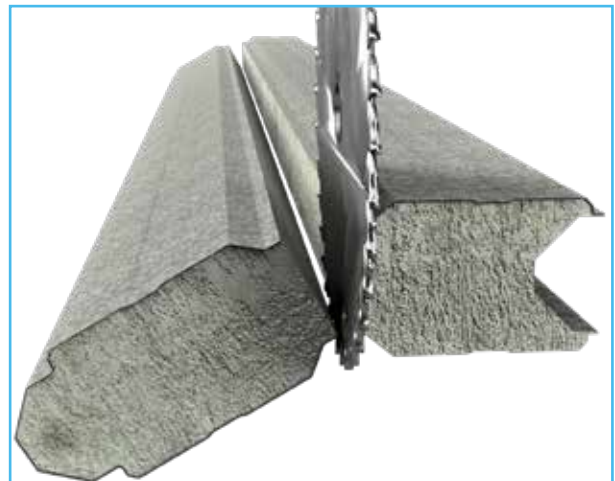

## HORIZONTAL INSTALLATION

### LAST PANEL

**10** To get the last horizontal panel in, cut out a 300mm angle section from each of the side C-tracks. Keep these two 300mm angle sections for use in Step 12.

**11** Keep placing the panels and fixing them to the panel below.

**12** Once the last panel is in position, fix the pieces of C-track that were removed in Step 10, back in place. Fire-rated sealant is then applied.

**13** Angle is then fixed to the soffit at 400 mm centres, then fixed to the panel at 400 mm centres. Fire rated sealant is applied.

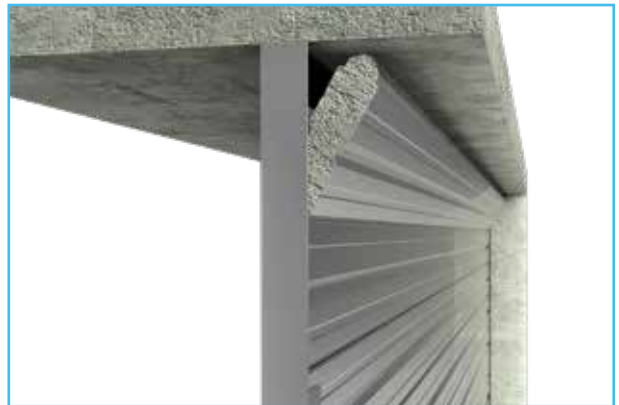

# HORIZONTAL INSTALLATION

## SCREW PLACEMENT

**14** Panels are screwed together into every panel joint at the horizontal centres shown in **Table 4** below.

**TABLE 4 - SCREW PLACEMENT HORIZONTAL INSTALLATION**

Panel Thickness	FRR	Wall Height	Panel Span	Maximum Centres	Sides
51 mm	-/60/60	0 to unlimited	0 to 4.0m	1000mm	One
78 mm	-/60/60	0 to unlimited	0 to 5.5m	1000mm	One
78 mm	-/120/120	0 to unlimited	0 to 5.0m	1000mm	One

## C-TRACK

C-track is fixed to the KOROK® panels with Wafer Tek 10g - 16 x 30mm screws at 250 mm centres into the panel joints on one side on the vertical C-track, and with Wafer Tek 10g - 16 x 16 mm screws at 400 mm centres on one side on the horizontal C-track.

At corners where two lengths of KOROK® C-track intersect, the two pieces must be fixed to each other with at least 1 Wafer Tek 10g - 16 x 16 mm screw.

## DEFLECTION C-TRACK DETAILS

Dead and live loads can cause significant deflection in some structures.

KOROK® can provide deflection C-track details where deflection loadings are considered.

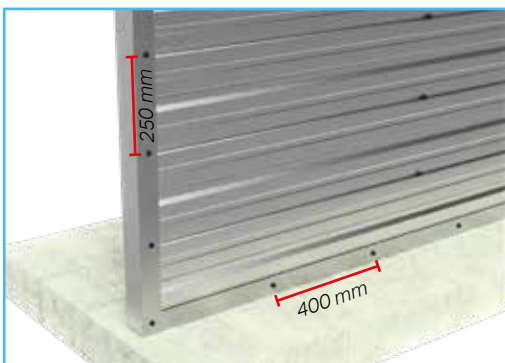

## HORIZONTAL INSTALLATION

### SEALANT PLACEMENT

**15** Remove any plastic film and then apply a continuous bead of fire rated sealant between the KOROK® C-track and the KOROK® panels.

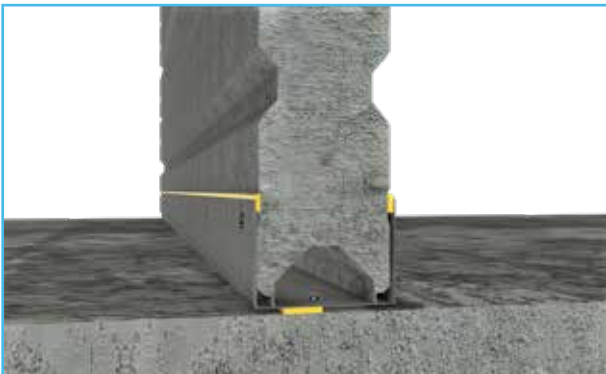
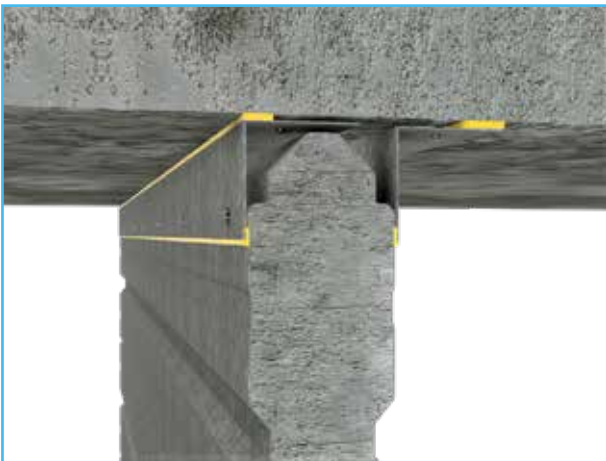

**16** Fire rated sealant details for top, bottom and sides.



### FINAL CHECK

At the completion of the job and at the finish of each day's work, it is essential that the completed area be thoroughly cleaned of all swarf, rivet stems, nails, drillings and screws etc. normally associated with the installation of metal KOROK® panels. Remove any remaining strippable film, check all fixings are correctly installed, all fire and acoustic sealant is applied correctly.

## CHANGING PANEL ORIENTATION

### MIX OF HORIZONTAL AND VERTICAL PANELS

In this application, vertical panels are supported by the structural support beam above and by the horizontal panels. When the maximum vertical panel height exceeds 1000mm, contact your engineer for specific details or contact us at KOROK® on 0800 773 777 or info@korok.com.

When used as a fire rated system refer to **Table 4** for maximum horizontal spans.

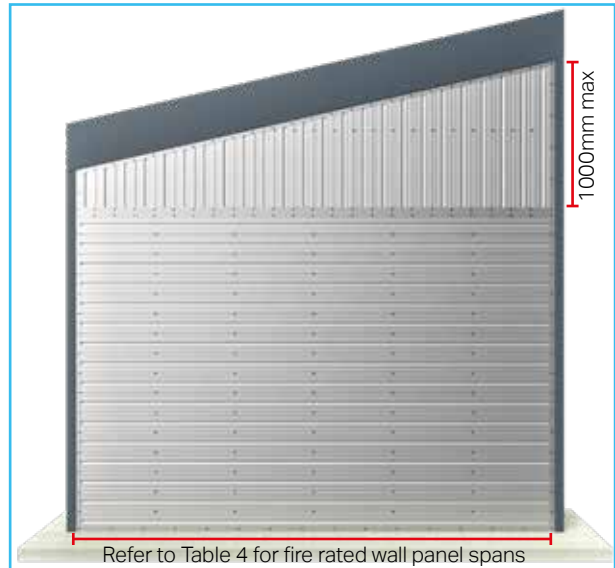

### CHANGING PANEL DIRECTION

Where transition occurs within the wall and a back to back C-track occurs. The C-track is fixed together at staggered 250 mm centres with a bead of sealant between channels. A flashing or 13 mm fire rated plasterboard must be fixed at 250 mm centres top and bottom over the joint on one side of the wall.

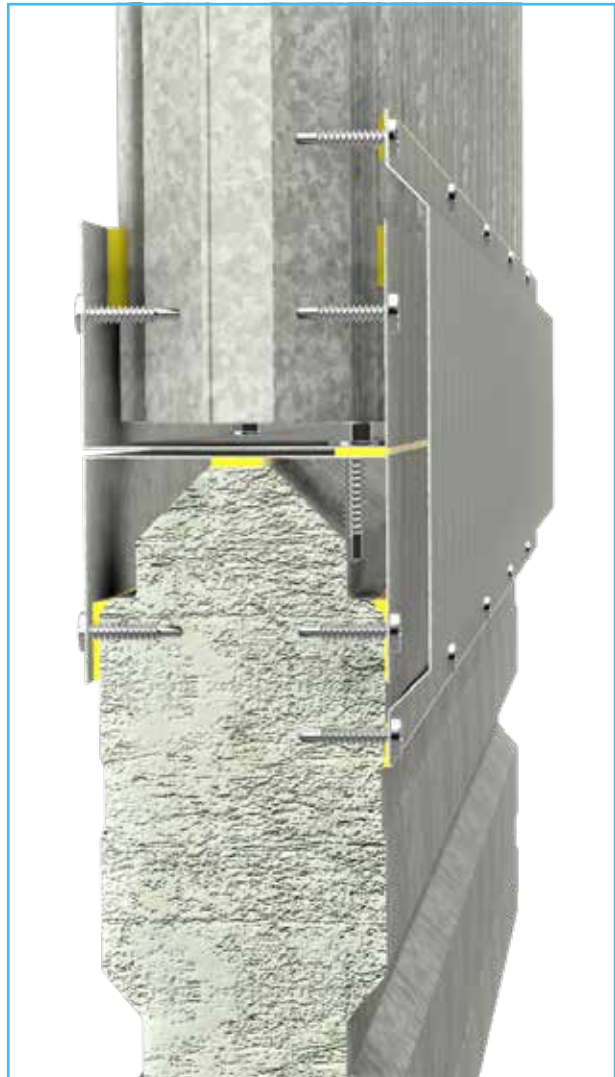

## GENERAL CORNERS AND JUNCTIONS

### VERTICAL WALL 90° CORNER DETAIL

Where internal or external corners are required, panels must be finished by fixing C-track to the vertical face. C-track must also be fixed to the side of the finished wall channel. Fire rated sealant must be used between the C-track. Fixings C-track to C-track must be at 250 mm staggered centres.

In addition to a standard connection, apply:

- A. an extra bead of fire rated sealant down each join edge (top picture)  
OR
- B. a 1.15 B.M.T. flashing on the outside corner (no picture)  
OR
- C. KOROK® Angle on the inside corner, fixed at 400 mm centres with fire rated sealant.

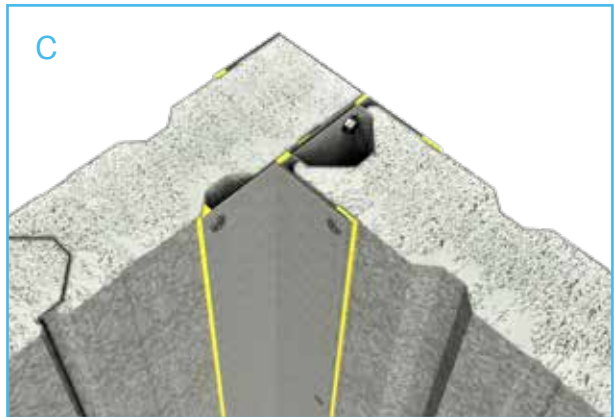

### T-JUNCTIONS

C-track must be fixed to the panel joint at 250 mm centres.

If the T-junction is off the panel joint, the C-track must be attached by screwing through the opposite side of the panel with a 14G x 115 Tek screw at 250 mm centres.

- An additional bead of fire rated sealant is applied to the inside corners (left picture)  
OR
- KOROK® Angle on the inside corner, fixed at 400 mm centres (right picture).

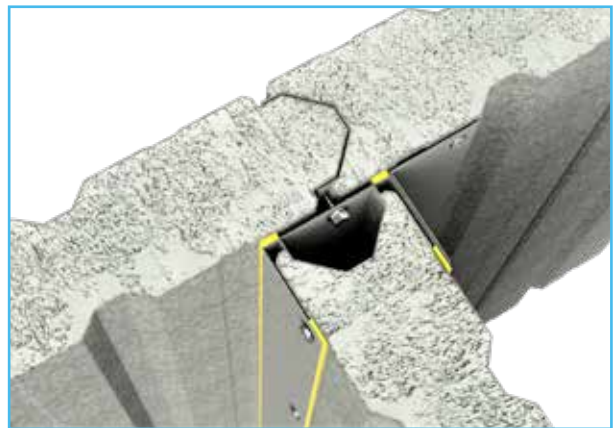
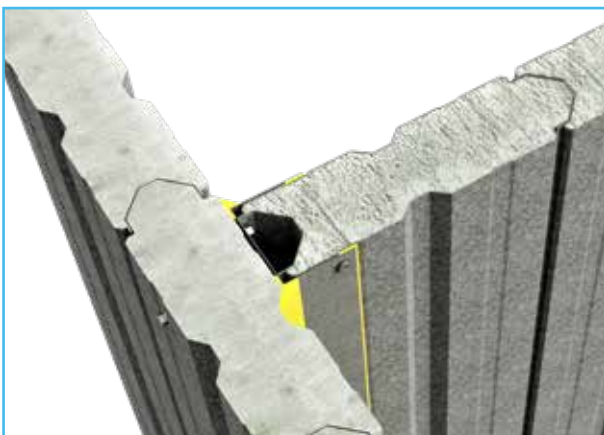

## UNSUPPORTED DOOR OPENINGS (MAX. WIDTH 2M)

Greater spans and wall heights and/or where additional load capacity is required are subject to specific design. Please contact us at KOROK® on 0800 773 777 or info@korok.com.



### DOORS IN KOROK® SYSTEMS

Additional fixings are used around doors. An additional row of fixings is required 50mm above the top of the door C-track, at 250 mm centres into the panel joints.

*For earlier fixing patterns please see previous technical and systems manuals.*



The vertical C-track is cut away at the top. The horizontal C-track is cut so that a flap can be folded down and screwed to the vertical C-track.

Alternatively, the C-track can be cut away at the corners so that the two pieces can be notched together. Then add a piece of KOROK® Angle to the inside of the corner.

# INSTALLATION INFORMATION

## DOORWAYS AND WINDOWS

C-track is cut to the trim size for doors, windows and large penetrations. As the wall is assembled the C-track is fitted and sealed and fixed as per the details.

## PENETRATIONS

Where penetrations into KOROK® are required, the use of a grinder, Sabre saw or hole saw to remove the steel shell is ideal. The aerated concrete is easily removed.

Any gaps in, or services that penetrate through fire rated construction are to be fire rated using certified proprietary systems such as fire collars, fire wraps, intumescent systems etc. The systems are to be installed to the specification of the manufacturer of the product.

KOROK® must be earthed where electrical equipment or unsheathed cables may come into contact with the metal work.

## PLUMBING AND ELECTRICAL SERVICES

Copper and brass piping must be isolated from direct contact with the steel shell. Similar care must be taken when contact with dissimilar metals is possible.

## SHELF LOADS

KOROK® can be used to carry shelf loads. The capacity of KOROK® to carry shelf loading is dependant upon variables such as shelf design, shelf fastening methods, wall height and shelf location.

## FIXING ACCESSORIES

Where practical, services and accessories must be fixed through the male/female shell connections, where the steel shell has greatest thickness (1.2mm B.M.T.).

Where loads are higher e.g. 50 x 50 timber framing for an internal gutter, fixings must extend through the panel.

## EXTERNAL WALL INSTALLATION

For external walls, KOROK® can provide site specific details. See our External Wall Systems Brochure.

## NEW ZEALAND BUILDING CODE (NZBC) COMPLIANCE

### New Zealand Building Code (NZBC) compliance

The NZBC sets out both the legal minimum sound

transmission between tenancies (Clause G6) and minimum levels of fire resistance (Clauses C3 and C6). KOROK® Systems Manuals provide guidance on the specification and construction of systems that will both meet and exceed those minimum levels. However, designers should consider the comfort of occupants when selecting a system that will satisfy the occupants' expectations when using the space rather than the minimum required by law.

### NZBC Clause B1 – Structure

KOROK® Wall Systems meet the requirements for loads arising from self-weight, earthquake, wind, impact and creep and shrinkage.

### NZBC Clause B2 – Durability

Under normal conditions of dry internal use KOROK® Wall Systems have a serviceable life in excess of 50 years and satisfy the requirements of NZBC Clause B2 – Durability.

### NZBC Clauses C3 - Fire affecting areas beyond the source

KOROK® Wall Systems can be used to provide passive fire protection in accordance with the requirements of NZBC Clause 3 – Spread of fire.

### NZBC Clause C6 - Structural Stability

Compliance with (NZBC) Clause C6 'Structural Stability'.

In order to satisfy the requirements of the New Zealand Building Code (clause 6) relating to "structural stability" designers must ensure that KOROK® elements are supported by primary elements that have at least the same fire rating as the KOROK® system that is used.

Where the primary elements supporting the KOROK® system are outside the fire cell, there is no requirement to apply the same FRR as the KOROK® system. Notwithstanding, post fire stability requirements of the NZBC must also be satisfied.

### NZBC Clause G6 – Airborne and Impact Sound

KOROK® Wall Systems, both meet and exceed the minimum requirements outlined in NZBC Clause G6. Consideration should be given to both the minimum requirements and the comfort of occupants.

## DEFLECTION C-TRACK DETAILS

Dead and live loads can cause significant deflection in some structures.

KOROK® can provide deflection C-track details where deflection loadings are considered.

Contact your KOROK® representative on 0800 773 777 for a solution specific to your project.



# INSTALLATION INFORMATION

## QUALITY CONTROL

The performance ratings of the published systems have been obtained by independent testing and opinions sourced from organisations with accredited quality assurance. It is of prime importance to pay strict attention to the details of design, construction and workmanship, otherwise the performance could be significantly degraded.

## DESIGN GUIDELINES

Please see the KOROK® panel Properties section of this manual beginning on Page 40, for the recommended maximum unsupported span for KOROK® Fire Rated Systems.

## LIMITATIONS

Adhesive fixing cannot replace mechanical fasteners in KOROK® Fire Rated Systems.

Do not install KOROK® above the span and height limits stated in this booklet without seeking advice from KOROK® Building Systems NZ Ltd.

## TRANSPORT

Generally the lengths of KOROK® are delivered to site by long trailers and articulated trucks. Therefore access to and on building sites must be adequate to accommodate these types of vehicles.

Off loading and site storage or crange onto site is the responsibility of the client and suitable arrangements should be made prior to delivery.

KOROK® products are packed and protected against damage during delivery but care must be exercised during unloading.

Lengths must be adequately supported during unloading and where packs are broken and panels lifted by hand, care must be taken not to slide or drag the panel and scrape the finished surfaces of the product.

## HANDLING AND STORAGE

KOROK® panels must be stored under clean, dry and ventilated conditions.

Where it is necessary for KOROK® panels to be stored onsite they should be placed away from the building operations, if possible, in the order in which they will be fixed.

Storage should provide a firm and dry base, protected from the weather, accidental damage and moisture.

The panels should be stored on bearers no more than 2000mm apart. Stack heights are limited to 8 pallets.

Adequate cover must be provided and water must not lie on or between the panel surfaces, which will cause staining and degradation of the surface coatings.

If pallets become wet the KOROK® panels should without delay be separated, wiped with a clean cloth and stacked so that the circulation of air will complete the drying process.

## STRIPPABLE FILM

KOROK® panels may be coated with a plastic film to provide protection during handling and transportation. This film has a very short life when exposed to exterior conditions and must be removed immediately after installation.

It must not be left lying in the sun or at the site for more than a few hours. Failure to remove the film will lead to difficulties later with its removal.

## CLEANING

At the completion of the job and at the finish of each days work, it is essential that the completed area be thoroughly cleaned of all swarf, rivet stems, nails, drillings and screws, etc., normally associated with the installation of metal panels.

Hot swarf should not be allowed to contact pre-painted sheet material. Any grinding, welding or drilling carried out above the wall level should be done with the panels appropriately covered to avoid swarf contact.

Failure to do so will result in unsightly staining of the surface as the metal particles rust or oxidise.

## ON SITE HANDLING

Handle KOROK® panels carefully prior to installation. Avoid knocks, bumps and scratches, which may lead to maintenance issues later.

Store KOROK® panels on site flat or in their pallets and ensure that KOROK® panels are dry prior to installation.

## INSTALLATION

Specific design advice should be sought where KOROK® is to be subject to point loads or other distributed loading other than wind.

Ensure connections between KOROK® panels are properly made.

Ensure connections of KOROK® panels to the structure are adequate.

# INSTALLATION INFORMATION

## MAINTENANCE

All cladding products are subject to the cumulative effects of weather, dust and other deposits. Maintenance regimes are to be in accordance with maintenance recommendations for New Zealand Steel Products used for wall cladding and are available at [www.nzsteel.co.nz/assets/Uploads/Files/Environmental-Categories-Warranty-Product-Maintenance-Recommendations-Brochure.pdf](http://www.nzsteel.co.nz/assets/Uploads/Files/Environmental-Categories-Warranty-Product-Maintenance-Recommendations-Brochure.pdf).

## MATERIAL SAFETY DATA SHEET

A Material Safety Data Sheet (MSDS) is available on request from KOROK® Building Systems NZ Ltd or from our website: [www.korok.com](http://www.korok.com)

## SPECIFICATION

KOROK® have prepared a technical specification suitable for inclusion in contract documents by Architects, Engineers or Builders. This may be freely copied (in full) or reproduced (in full) and is available by contacting us at KOROK® on 0800 773 777 or [info@korok.com](mailto:info@korok.com), or from [www.korok.com](http://www.korok.com).

## WARRANTY

KOROK® Building Systems NZ Ltd supplies the KOROK® wall system and warrants it to be free from defects in material and workmanship. KOROK® Building Systems NZ Ltd will at its own option replace and/or repair any product found to be defective, provided it has been stored, installed and maintained strictly in accordance with the requirements and recommendations of KOROK® technical literature. This warranty is in addition to any statutory rights to the customer.

KOROK® Building Systems NZ Ltd cannot be held responsible for deterioration to galvanised products caused by poor handling or storage practices after the product has arrived at the customers site.

All KOROK® building products are designed to satisfy New Zealand conditions.

## DISCLAIMER

KOROK® Building Systems NZ Ltd reserves the right, at any time, at its own discretion and without notice, to discontinue or change the features, designs, materials, colours and other specifications of its products and to either permanently or temporarily withdraw any such products from sale without incurring any liability.

This booklet is published as a general guide only

and must not be used in preference to detailed technical advice from an appropriately qualified person where application differs from those described herein.

To the best of KOROK® Building Systems NZ Ltd knowledge, all information is correct at the time of printing.

Whilst every effort has been made to ensure the material contained within this document is accurate and correct, no responsibility or liability, in part or whole by the authors, editors or publishers of this manual will be accepted for misuse, misreading or deviation from the recommended installation details.

## BEWARE OF SUBSTITUTIONS

All KOROK® systems have been designed and tested to ensure they are suitable for New Zealand conditions and provide specific resistance to fire and acoustic transmission.

As such, only tested KOROK® panels and components can be used in the construction of each KOROK® system, ensuring that the finished wall will meet its performance specification.

KOROK® is unable to support system performance where substitute products are used as they have not been tested by us as part of our systems and we cannot be responsible for the ongoing quality and performance of these products.

## LIABILITY

KOROK® New Zealand accepts no liability if any KOROK® Fire Rated System or Acoustic Rated System is not designed and installed in strict accordance with instructions contained in this publication.

## IS THIS PUBLICATION CURRENT?

This publication may be superseded by a new publication. KOROK® Building Systems NZ Ltd accepts no liability for reliance upon publications that have been superseded.

If you are unsure whether this is the current publication, you can check by contacting us at KOROK® on 0800 773 777 or [info@korok.com](mailto:info@korok.com), or on [www.korok.com](http://www.korok.com).

This may be freely copied (in full) or reproduced (in full) and is available by contacting us at KOROK® on 0800 773 777 or [info@korok.com](mailto:info@korok.com), or from [www.korok.com](http://www.korok.com).

# PANEL PROPERTIES

## KOROK® PANELS

KOROK® panels are roll-formed from zinc-coated steel strips. The steel from which the shells are manufactured conforms to AS1397: 2011.

Steel shells have a base metal thickness of 0.4 mm B.M.T. with a Z275 zinc coating. These panels have an aerated concrete core and weigh nominally 10.2 kg per lineal metre.

KOROK® panels have 250 mm coverage when installed.

## LOADING COMBINATIONS

All loading combinations are in accordance with AS/NZS 1170.0:2002.

## GENERAL DESIGN NOTES

The designs specified in this manual have been carried out in accordance with AS/NZS1170 and laboratory testing carried out by BRANZ Limited.

The tables and charts are prepared for the use of KOROK® in wall applications i.e. floor systems cannot be modelled from the safe load tables in this manual. Interpolation of the tables is acceptable.

## STANDARDS

### **NZS 2589.1-2017**

Gypsum Linings in residential and light commercial construction.

### **AS/NZS 1170.0-2002**

Structural design actions. Part 0: General Principles

### **NZS 7202-1986**

Part 1 Specification for gap filling adhesives

### **AS 4072.1-2005**

Components for the protection of openings in fire-resistant separating elements

### **AS 1530.4-2014**

Methods for fire tests on building materials, components and structures

## REFERENCES

The following references including standards and codes of practice govern the manufacture of components, use and design and installation of KOROK® systems.

## MANUFACTURERS DOCUMENTS

Refer to KOROK® Systems Manuals.

- Autex® Insulation Data Sheets
- GIB® Site Guide
- GIB® Fire Rated Systems
- Penetrations and closures in GIB® Fire Rated Systems
- GIB® Noise Control Systems
- Hilti® New Zealand Technical Manual
- Pink® Batts® Data Sheets
- Powers Fasteners Specification & Design Manual
- Rondo® Steel Stud & Tracks Installation Manual
- USG® Drywall Steel Stud & Track System
- USG® Boral Plasterboard Installation Manual NZ

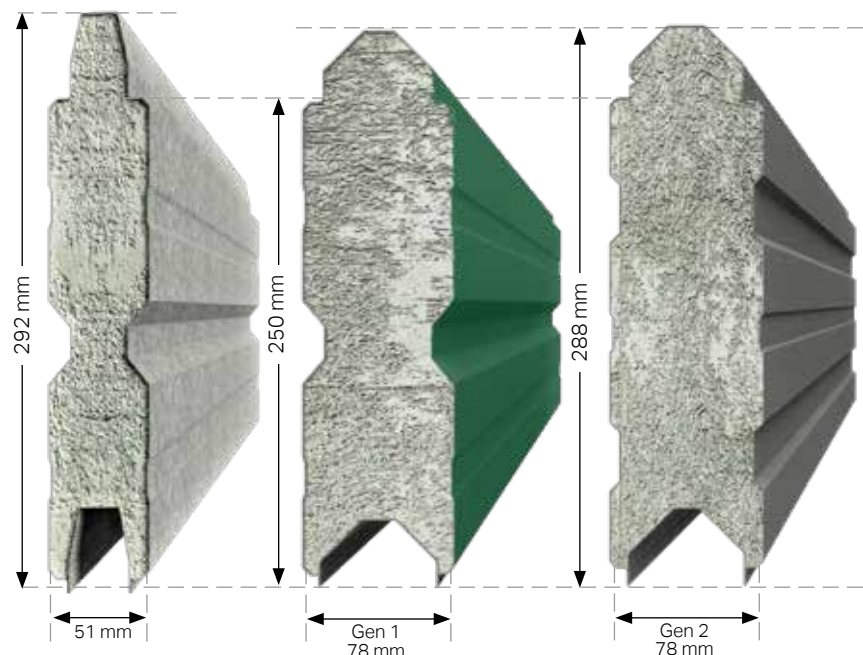

# KOROK® PANEL PROPERTIES: 78 MM 400 KG/M<sup>3</sup>

## KOROK® PANEL PROPERTIES

- Base Metal Thickness 0.4 mm B.M.T.
  - Mass kg per lineal metre 10.2 nominal
  - Mass kg/m<sup>2</sup> 40.8 nominal
- EI** 60 kNm<sup>2</sup> per panel (*bending stiffness, minor axis*)
- EI** 387 kNm<sup>2</sup> per panel (*bending stiffness, major axis*)
- EA** 4060 kN per panel (*axial stiffness*)
- GJ** 583 kNm<sup>2</sup> per panel (*torsional stiffness*)

## VERTICAL SPAN WALLS

- Maximum bending moment / panel 1.43 kNm (ULS)
- Maximum axial end crush force / panel 25 kN (ULS)  
3.4 kN (SLS)
- Maximum horizontal reaction (crushing on flat) / panel  
8.9 kN (ULS) 3.1 kN (SLS)

## HORIZONTAL SPAN WALLS

- Maximum bending moment / panel 1.43 kNm (ULS)
- Maximum axial edge crush force per unit length  
17 kN/m (ULS) 6k N/m (SLS)
- Maximum horizontal reaction / panel 8.9 kN (ULS)  
3.1 kN (SLS)

## THERMAL RESISTANCE

- R Value 0.30 (m<sup>2</sup>K)/W
- U Value 3.2 W/(m<sup>2</sup>K)

## DEFINITIONS

**ULS:** Value shown is for Ultimate Limit State loading

**SLS:** Value shown is for Serviceability Limit State loading

## USE OF TABLES

1. These Span Tables are based on ambient conditions.
2. When used as part of a fire rated system, the maximum unsupported vertical span of the KOROK® 78 mm panel is 6.0 metres. The maximum unsupported horizontal span of the KOROK® 78 mm panel is 5.0 metres. Greater spans or walls where additional load carrying capacity is required are subject to specific engineering design and/or fire engineering assessment.

3. Shelf loading requires specific engineering design.
4. Determine the loads on the KOROK® in accordance with AS/NZS 1170.0.
5. Use **Table 6 - Horizontal Span** to ensure that walls spanning horizontally can carry the loads previously calculated. Use **Table 7 - Vertical Span** to ensure that walls spanning vertically can carry the loads previously calculated. Interpolation of points in the tables is allowed.
6. The Tables have been generated for a range of deflection limits i.e. Span/150, Span/200, Span/250, Span/300 in both the vertical and horizontal KOROK® panel configurations.
7. The walls must be checked for both ultimate limit state (ULS) loading and serviceability limit state (SLS) loading.
8. Vertical Span Tables have been generated to a maximum unsupported span of 8.0 metres height.
9. Horizontal Span Tables have been generated based on a 14.0 metres high wall.
10. For horizontal panel unsupported spans over 5.0 metres, for maximum wall heights please contact us at KOROK® on 0800 773 777.

## DEFLECTION C-TRACK DETAILS

Dead and live loads can cause significant deflection in some structures.

KOROK® can provide deflection C-track details where deflection loadings are considered.

Contact your KOROK® representative on 0800 773 777 for a solution specific to your project.

## SUPPORTING STRUCTURES

KOROK® walls must be supported. The supporting structures themselves must be specifically designed to carry the load of the KOROK® walls.

The fastener strengths shown in this section may be used to design the connections. Maximum spacing of fasteners is shown on installation information.

## INSTALLATION NOTE

All KOROK® C-track to structure, KOROK® C-track to KOROK®, and KOROK® to KOROK® panel connections shall be in accordance with details specified in this manual unless specified otherwise by the Project Engineer.

# KOROK® PANEL PROPERTIES: 78 MM 400 KG/M<sup>3</sup>

TABLE 5 - SHEAR STRENGTH PER FASTENER FOR THE FOLLOWING CONNECTIONS

CONNECTION	LOAD DIRECTION	TYPE	DESIGN STRENGTH (KN) ULS	DESIGN STRENGTH (KN) SLS
Panel to panel	In-plane	10x16 galvanised Steeltite wafer head screws	1.01	0.83
Panel sides to C-track	In-plane	10x16 galvanised Steeltite wafer head screws	0.95	0.78
Panel sides to C-track	Out-of-plane	10x16 galvanised Steeltite wafer head screws	0.91	0.74
Panel ends to C-track	In-plane	10x16 galvanised Steeltite wafer head screws	0.91	0.74
Panel ends to C-track	Out-of-plane	10x16 galvanised Steeltite wafer head screws	2.21	0.77
C-track to concrete	In-plane	6.5x32 Rawl Mushroom spikes	7.84	2.27
C-track to concrete	Out-of-plane	6.5x32 Rawl Mushroom spikes	7.84	2.27
C-track to steel support	In-plane	Hilti® X-ENP-10 L15 Nails	4.32	2.31
C-track to steel support	Out-of-plane	Hilti® X-ENP-10 L15 Nails	4.32	2.31
KOROK® aluminium bracket to panel joint	Out-of-plane	Hex Head Type 17 14g x 35mm screws	0.92	0.92

TABLE 6 - HORIZONTAL SPAN

SPAN (M)	ULS DESIGN	SLS DESIGN L/150	SLS DESIGN L/200	SLS DESIGN L/250	SLS DESIGN L/300
2	10.05		9	7.7	6.7
2.5	7.3	6.02	4.94	4.2	3.64
3	5.04	3.7	3	2.5	2.17
3.5	3.7	2.42	1.95	1.63	1.39
4	2.82	1.67	1.34	1.1	0.94
4.5	1.94	1.19	0.94	0.78	0.66
5	1.37	0.88	0.69	0.56	0.47
6	0.72	0.51	0.39	0.32	0.26
7	0.38	0.31	0.23	0.19	0.15
8	0.17	0.17	0.14	0.11	0.09

Maximum pressure that can be resisted by a horizontal span (kPa)

Horizontal Span Table has been generated based on a 14m high wall.

For unsupported horizontal spans over 5.0m please contact us at KOROK® on 0800 773 777 for maximum wall heights.

TABLE 7 - VERTICAL SPAN

SPAN (M)	ULS DESIGN	SLS DESIGN L/150	SLS DESIGN L/200	SLS DESIGN L/250	SLS DESIGN L/300
2	10.05		9.05	7.75	6.77
2.5	7.3	6.05	4.95	4.2	3.64
3	5.04	3.7	3	2.53	2.18
3.5	3.7	2.42	1.96	1.64	1.4
4	2.82	1.68	1.34	1.12	0.95
4.5	2.23	1.21	0.96	0.79	0.67
5	1.79	0.9	0.71	0.58	0.49
6	1.22	0.54	0.42	0.34	0.28
7	0.89	0.34	0.26	0.21	0.17
8	0.66	0.23	0.17	0.14	0.11

Maximum pressure that can be resisted by a vertical span (kPa)

Vertical Span Table has been generated to a maximum of 8m wall height. Length of the wall is not a consideration when calculating span.

# KOROK® PANEL PROPERTIES: 51 MM 600 KG/M<sup>3</sup>

## KOROK® PANEL PROPERTIES

- Base Metal Thickness 0.4 mm B.M.T.
  - Mass kg per lineal metre 10.1 nominal
  - Mass kg/m<sup>2</sup> 40.4 nominal
- EI** 24 kNm<sup>2</sup> per panel (*bending stiffness, minor axis*)
- EI** 400 kNm<sup>2</sup> per panel (*bending stiffness, major axis*)
- EA** 4060 kN per panel (*axial stiffness*)
- GJ** 27 kNm<sup>2</sup> per panel (*torsional stiffness*)

## VERTICAL SPAN WALLS

- Maximum bending moment / panel 0.96 kNm (ULS)
- Maximum axial end crush force / panel 32 kN (ULS) 2.9 kN (SLS)
- Maximum horizontal reaction (crushing on flat) / panel 1.08 kN (ULS) 0.93 kN (SLS)

## HORIZONTAL SPAN WALLS

- Maximum bending moment / panel 0.96 kNm (ULS)
- Maximum axial edge crush force per unit length 5.5 kN/m (ULS) 0.77 kN/m (SLS)
- Maximum horizontal reaction / panel 1.08 kN (ULS) 0.93 kN (SLS)

## DEFINITIONS

**ULS:** Value shown is for Ultimate Limit State loading

**SLS:** Value shown is for Serviceability Limit State loading

## USE OF TABLES

1. These Span Tables are based on ambient conditions.
2. When used as part of a fire rated system, the maximum unsupported vertical span of the KOROK® 51 mm panel is 5.0 metres. The maximum unsupported horizontal span of the KOROK® 51 mm panel is 4.0 metres. Greater spans or walls where additional load carrying capacity is required are subject to specific engineering design and/or fire engineering assessment.
3. Shelf loading requires specific engineering design.
4. Determine the loads on the KOROK® in accordance with AS/NZS 1170.0.

5. Use **Table 9 - Horizontal Span** to ensure that walls spanning horizontally can carry the loads previously calculated. Use **Table 10 - Vertical Span** to ensure that walls spanning vertically can carry the loads previously calculated. Interpolation of points in the tables is allowed.
6. The Tables have been generated for a range of deflection limits i.e. Span/150, Span/200, Span/250, Span/300 in both the vertical and horizontal KOROK® panel configurations.
7. The walls must be checked for both ultimate limit state (ULS) loading and serviceability limit state (SLS) loading.
8. Vertical Span Tables have been generated to a maximum unsupported span of 5.0 metres height.
9. Horizontal Span Tables have been generated based on a 5.0 metres high wall.
10. For horizontal panel unsupported spans over 4.0 metres, for maximum wall heights please contact us at KOROK® on 0800 773 777.

## DEFLECTION C-TRACK DETAILS

Dead and live loads can cause significant deflection in some structures.

KOROK® can provide deflection C-track details where deflection loadings are considered.

Contact your KOROK® representative on 0800 773 777 for a solution specific to your project.

## SUPPORTING STRUCTURES

KOROK® walls must be supported. The supporting structures themselves must be specifically designed to carry the load of the KOROK® walls.

The fastener strengths shown in this section may be used to design the connections. Maximum spacing of fasteners is shown on installation information.

## INSTALLATION NOTE

All KOROK® C-track to structure, KOROK® C-track to KOROK®, and KOROK® to KOROK® panel connections shall be in accordance with details specified in this manual unless specified otherwise by the Project Engineer.

# KOROK® PANEL PROPERTIES: 51 MM 600 KG/M<sup>3</sup>

TABLE 8 - SHEAR STRENGTH PER FASTENER FOR THE FOLLOWING CONNECTIONS

CONNECTION	LOAD DIRECTION	TYPE	DESIGN STRENGTH (KN) ULS	DESIGN STRENGTH (KN) SLS
Panel to panel	In-plane	10x16 galvanised Steeltite wafer head screws	1.01	0.83
Panel sides to C-track	In-plane	10x16 galvanised Steeltite wafer head screws	0.95	0.78
Panel sides to C-track	Out-of-plane	10x16 galvanised Steeltite wafer head screws	0.91	0.74
Panel ends to C-track	In-plane	10x16 galvanised Steeltite wafer head screws	0.91	0.74
Panel ends to C-track	Out-of-plane	10x16 galvanised Steeltite wafer head screws	2.21	0.77
C-track to concrete	In-plane	6.5x32 Rawl Mushroom spikes	7.84	2.27
C-track to concrete	Out-of-plane	6.5x32 Rawl Mushroom spikes	7.84	2.27
C-track to steel support	In-plane	Hilti® X-ENP-10 L15 Nails	4.32	2.31
C-track to steel support	Out-of-plane	Hilti® X-ENP-10 L15 Nails	4.32	2.31
KOROK® aluminium bracket to panel joint	Out-of-plane	Hex Head Type 17 14g x 35mm screws	0.92	0.92

TABLE 9 - HORIZONTAL SPAN

SPAN (M)	ULS DESIGN	SLS DESIGN L/150	SLS DESIGN L/200	SLS DESIGN L/250	SLS DESIGN L/300
2	7.66		6.22	4.98	4.15
2.5	4.90	4.25	3.18	2.55	2.12
3	3.40	2.46	1.84	1.47	1.23
3.5	2.50	1.55	1.16	0.93	0.77
4	1.91	1.04	0.78	0.62	0.52

Maximum pressure that can be resisted by a horizontal span (kPa)  
For horizontal panel, the maximum unsupported span is 4m.

Unsupported horizontal wall spans greater than 4m are subject to specific design.















TABLE 10 - VERTICAL SPAN

SPAN (M)	ULS DESIGN	SLS DESIGN L/150	SLS DESIGN L/200	SLS DESIGN L/250	SLS DESIGN L/300
2	7.66		6.22	4.98	4.15
2.5	4.90	4.25	3.18	2.55	2.12
3	3.40	2.46	1.84	1.47	1.23
3.5	2.50	1.55	1.16	0.93	0.77
4	1.91	1.04	0.78	0.62	0.52
4.5	1.51	0.73	0.55	0.44	0.36
5	1.22	0.53	0.40	0.32	0.27

Maximum pressure that can be resisted by a vertical span (kPa)  
The length of the wall is not a consideration when calculating span.

## KOROK® COMPONENTS SUMMARY

Product Image	Item Description
	KOROK® C-track 60 x 51 x 60 mm 1.15B.M.T.
	KOROK® C-track 60 x 80 x 60 mm 1.15B.M.T.
	KOROK® J-track 70 x 51 x 60 mm 1.15B.M.T.
	KOROK® J-track 70 x 80 x 60 mm 1.15B.M.T.
	KOROK® panel 51 mm wide 250 mm cover 600 kg/m³ density
	KOROK® panel 78 mm wide 250 mm cover 400 kg/m³ density (Colour)
	KOROK® GEN 2 panel 78 mm wide 250 mm cover 400 kg/m³ density (Galvanised)
	Hilti DBZ 6/4.5 x 32 mm
	6.5 x 32 Rawl Mushroom spikes
	Wafer Tek 10g - 16 x 16 mm Class 3
	Wafer Tek 10g - 16 x 30mm Class 3
	Sikaflex-400 Fire Rated Sealant
	Hilti CP606 PROMASEAL®-A

Product Image	Item Description
	Hex Head Type 17 14g x 35mm
	Hex Head SDS 14g x 22mm
	Hex Head SDS 14g x 115mm
	Aluminium bracket 75 x 50 x 40 x 3mm
	Hilti X-ENP-19 L15 fasteners (strip of 10)
	Hilti DX76 fasteners (as above)
	Hilti DX76 yellow charges
	KOROK® KIT flashing
	KOROK® fire flashing
	KOROK® Angle
	KOROK® Exterior 3mm base angle
	KOROK® Internal base cover flashing
	Hilti HUS3-P 6 Concrete screw anchor
	Hilti HUS3-H 6 Concrete screw anchor



# TABLE 11 - KOROK® FASTENERS SPACINGS

PUBLICATION	KOROK® WALL SYSTEM OR SIMILAR	PANEL THICKNESS (MM)	PANEL ORIENTATION	MAXIMUM WALL HEIGHT (M)	MAXIMUM WALL SPAN/WIDTH (M)	PANEL TO PANEL			PANEL TO PERPENDICULAR C-TRACK			NOTES:	
						MAXIMUM CENTRES (MM)	SIDES OF WALL	TEK SCREW	MAXIMUM CENTRES (MM)	PANEL FACE OR JOINT	SIDES OF C-TRACK		TEK SCREW
	FS & NCS systems	78	Vertical	9m		1000	one	10-16	250	Face	One	10-16	See note 2.
	FS & NCS systems	78	Horizontal	unlimited	5.0m between structural supports	1000	one	10-16	250	Joint	One	10-30	
	FS & NCS systems	78	Horizontal	14m	Over 5.0m between structural supports	1000	one	10-16	250	Joint	One	10-30	
Intertency - Terraced Housing	KIT01 to KIT5	51	Vertical	12m	3m between aluminium brackets	1000	one	10-16	250	Face	One	10-16	See flashing details for FRR
Intertency - Terraced Housing	KIT06 to KIT10	78	Vertical	12m	3m between aluminium brackets	1000	one	10-16	250	Face	One	10-16	See flashing details for FRR
Intertency - Apartments	KIM01-05, KIM08-09, KIM12-13	51	Vertical	5m		1000	one	10-16	250	Face	One	10-16	
Intertency - Apartments	KIM06 to KIM07	78	Vertical	6m		1000	one	10-16	250	Face	One	10-16	
External Wall Systems	EX1	78	Vertical	9m	6.0m between girts	1000	one	10-16	Into slab angle. 2 fixings per panel	Face	One	14-115	

## NOTES

- For C-track running parallel to the panels, 10-16 Tek screw fixings at 400 mm centres are used one side.
- 78 mm Panel Properties - These span tables are based on ambient conditions. When used as part of a fire rated system, the maximum unsupported vertical span of the KOROK® panels is 6.0 metres and the maximum unsupported horizontal span is 5.0 metres. Greater spans are subject to specific engineering design and/or fire engineering assessment.
- 51 mm Panel Properties - These span tables are based on ambient conditions. When used as part of a fire rated system, the maximum unsupported span of the KOROK® panels is 5.0 metres vertical or 4.0 metres horizontal. Greater unsupported spans will require specific FRR design.
- Deflection c-track details - Dead and live loads can cause significant deflection in some structures. KOROK® can provide deflection C-track details where deflection loadings are considered.



# SUSTAINABILITY

KOROK® is a high performance product with minimal impact on the planet

KOROK® is made to order, ensuring minimal on-site waste

KOROK® is fully re-usable

KOROK® is fully recyclable

KOROK® is manufactured in NZ

## Declare.

**KOROK panel**  
**KOROK Building Systems NZ Ltd**

**Final Assembly:** Hamilton, New Zealand  
**Life Expectancy:** 50 Year(s)  
**End of Life Options:** Salvageable/Reusable in its Entirety, Recyclable (100%)

**Ingredients:**

Portland Cement; Low Carbon Steel; Water; Fly Ash; Washed Fine Sand; Anionic Detergent Blend (0.01%); Antimony; Nonionic Surfactant; Polypropylene Filaments; Zinc

<sup>1</sup>LBC Temp Exception RL-004b - Proprietary Ingredients in Declare

**Living Building Challenge Criteria:** Compliant

**I-13 Red List:**

LBC Red List Free      % Disclosed: 99.99% at 100ppm  
 LBC Red List Approved      VOC Content: Not Applicable  
 Declared

**I-10 Interior Performance:** Not Applicable

**I-14 Responsible Sourcing:** Not Applicable

KOR-0001  
EXP. 01 OCT 2024  
Original Issue Date: 2018

FOR MORE INFORMATION ON RESPONSIBLE PRODUCT SOURCING, VISIT: [living-future.org/declare](https://www.living-future.org/declare)  
INTERNATIONAL LIVING FUTURE INSTITUTE™ [living-future.org/declare](https://www.living-future.org/declare)

 **NZGBC**  
TE KAUNIHERA HANGANGA TAUTAIAO

Member 2024-2025





22 Norris Ave  
PO Box 20182  
Te Rapa, Hamilton  
0800 773 777  
[www.korok.com](http://www.korok.com)