

CEMINTEL[®]

TERRITORY[™]

NEW ZEALAND DESIGN AND INSTALLATION GUIDE

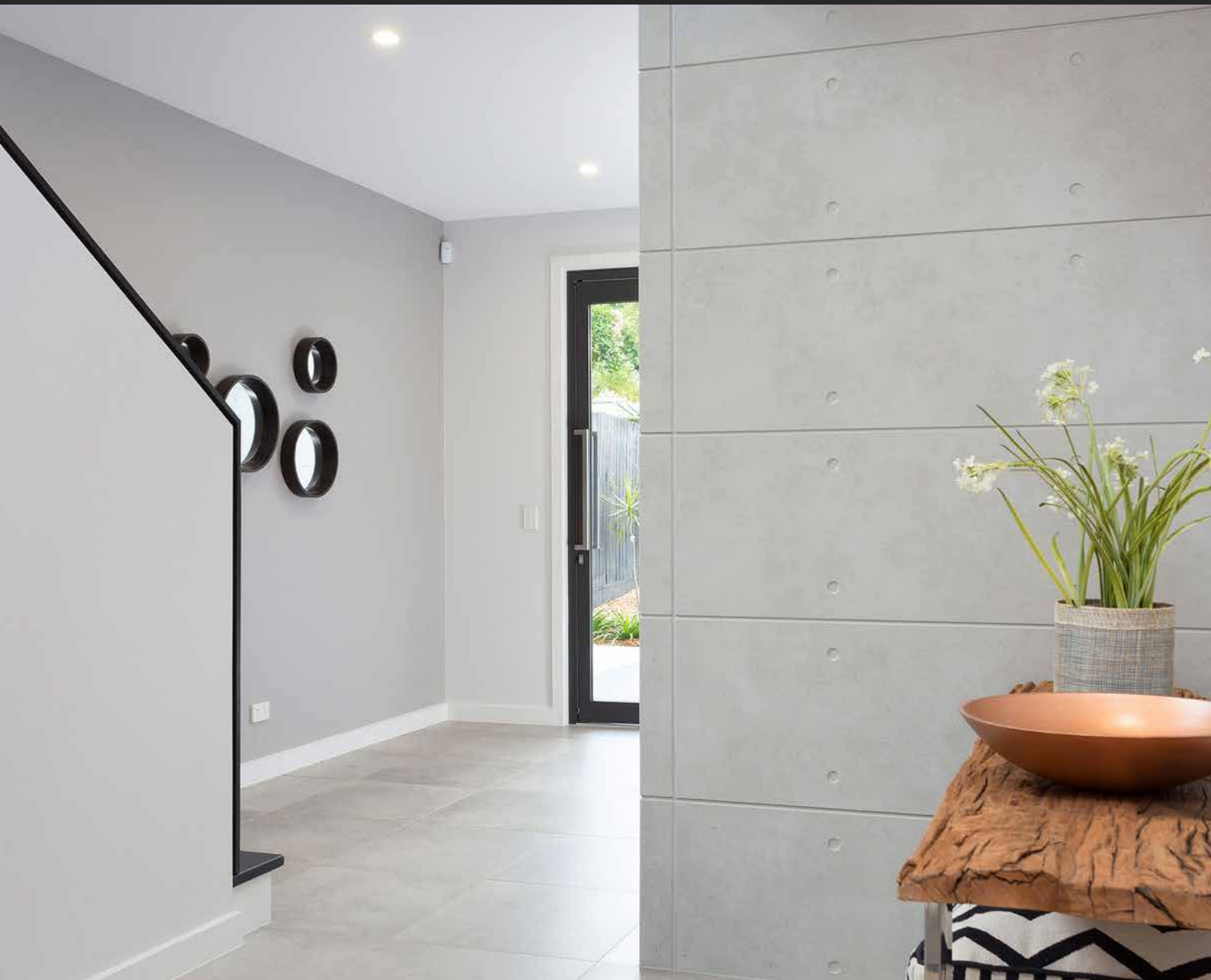

INTRODUCTION

TABLE OF CONTENTS

01 INTRODUCTION	1	07 INSTALLATION	17
Introduction	1	Prior to Installation	18
02 PRODUCT OVERVIEW	2	Horizontal	
Panel Information	3	Installation Set-Out	19
Colour Palette	4	Installation for Timber and Steel Framing	22
03 SYSTEM OVERVIEW	5	Vertical	
Applications	7	Installation Set-Out	25
Benefits of the Cemintel Territory System	7	Installation for Timber and Steel Framing	29
Product Specifications	7	08 CONSTRUCTION DRAWINGS	
04 DESIGN + AESTHETIC CONSIDERATIONS	8	+ DETAILS	32
General	9	Horizontal Installation	34
Control Joints	10	Vertical Installation	37
Structural	10	09 SAFETY, HANDLING + GENERAL CARE	40
Other Design Considerations	11	Health, Safety and PPE	41
05 COMPONENTS + ACCESSORIES	12	Handling & General Care	41
06 SYSTEM ENGINEERING	15	10 WARRANTY, CLEANING	
Design, Detailing and Performance		+ MAINTENANCE	42
Responsibilities	16	Warranty	42
		Wash Down Process	42

Introduction

Cemintel's Territory™ cavity walling system combines a prefinished panel with a simple installation system that can be used externally or internally for residential and commercial buildings.

This Design and Installation Guide recommends good building practice methodology and has been prepared as a general guide of design considerations, system engineering information and installation procedures for common internal applications. It assumes that the user has an intermediate knowledge level of building design and construction. In no way does it replace the services of the building professionals required to design projects, nor is it an exhaustive guide of all possible scenarios. It is the

responsibility of the architect, designer and various engineering parties to ensure that the details in this Design and Installation Guide are appropriate for the intended application.

Territory can be installed either horizontally or vertically, externally or internally. This guide refers to **internal installations** only, as components differ depending on the installation.

Refer to the 'Design and Installation Guide for Cemintel® Territory External Vertical Installation' or the 'Design and Installation Guide for Cemintel Territory External Horizontal Installation' for instructions regarding these applications.



PRODUCT OVERVIEW

Panel Information

Cemintel Territory panels are cement bonded fibrous wood particle products that are pressed with a surface texture. They are cut to a standard length of 3030mm with an effective cover width of 455mm and 16mm nominal thickness. The horizontal edges of the panel are machined with a complementary tongue and groove profile. A compressible sealing strip is bonded onto the tongue which enables the panels to fit neatly together to form a weather resistant joint.

The panels have been pre-finished using a durable multi-layered paint process to simulate a range of textured finishes, for example, timber, concrete, stone or render. They are ready-to-install and are highly durable.

Panels have a special NichiGuard® self cleaning coating* applied during the manufacturing process to Japanese standards. Panels include Platinum Coating technology to protect against UV damage and colour fade.

There is a range of colour matched accessories including pre-formed external corner profiles, joint sealants and touch up paint kits to speed installation and enhance the project finish and appearance.

An alternative aluminium corner can also be used for a more contemporary aesthetic.

*Note: not all panels have NichiGuard self cleaning coating – check Technical Data Sheet.

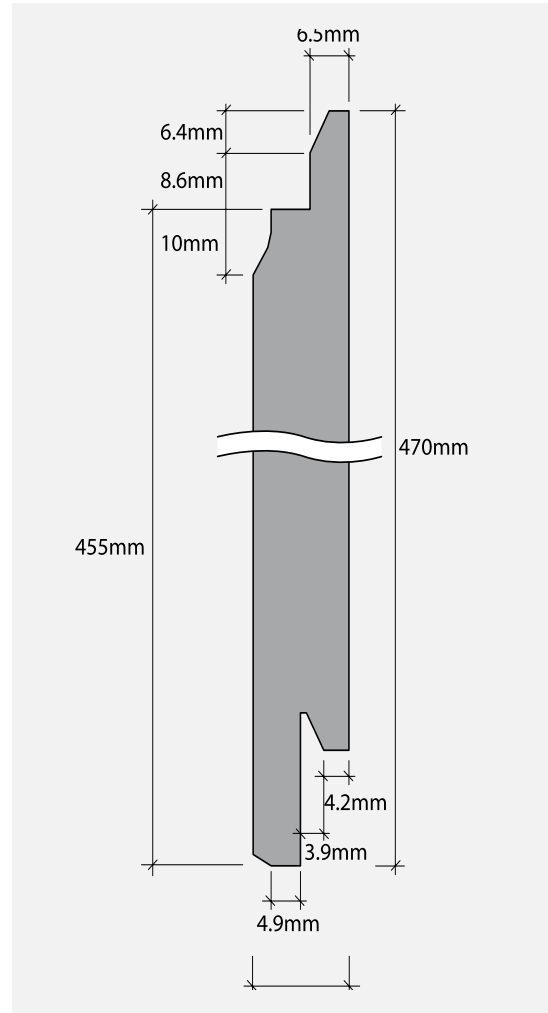

PRODUCT OVERVIEW



NZ Stocked Colour Palette

S = Stocked **I** = Indent

Woodlands



Teak



Grey Gum



Ebony



Jarrah Slats



Kwila Slats



Oak Slats



Smoked



Cedar



Limed

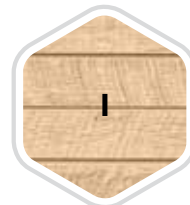

Birch

Quarry



Urban Grey



Concrete



Mottled Rustic Brick



Black Modern Brick



Grey Rustic Brick



White Rustic Brick

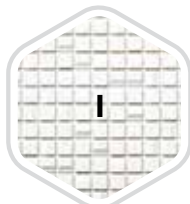

Mosaic White



Mosaic Ivory



Mosaic Brown

Ridge



Black



White

Canyon



Kings



Katherine



Carnavon

Savanna

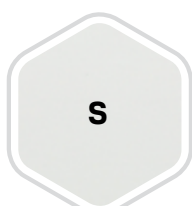

Cloud



Haze

As Territory is a prefinished product, product images may vary from the actual product in regard to colour and surface finish. Panels should be inspected by the owner prior to installation to ensure they meet aesthetic requirements.

Indent only products require additional lead times and have minimum order quantities.



SYSTEM OVERVIEW

SYSTEM OVERVIEW



Cemintel Territory panels are installed with the unique Designer Series clip system.

Territory panels can be installed either horizontally or vertically. Designer Series clips, together with 5mm spacer strips and base starter strips create a largely concealed fixing system.

Metal corners can be used as an easy alternative to the pre-formed corners shown below.

Horizontal Installation

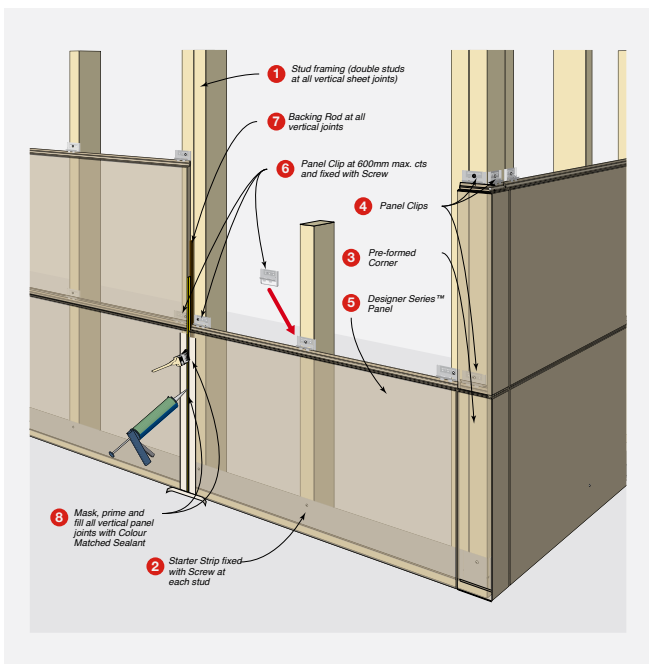

When installed **horizontally**:

- Panels span up to 3030mm width without joints.
- Studs can be at any spacings up to 600mm centres.
- Double studs or blocking are required behind vertical expressed joints to provide for fixing of the clips.

Vertical Installation

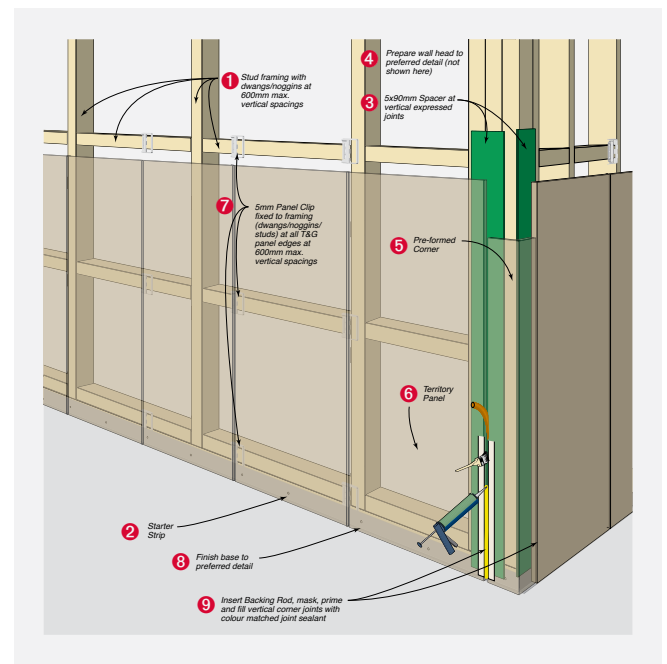

When installed **vertically**:

- Panels span up to 3030mm height without joints.
- Noggins/dwangs can be at any spacings up to 600mm centres.
- Horizontal battens are fixed to studs making this system particularly suitable for retro-fit to existing stud framing.
- Additional studs or blocking may be required at wall ends or at junctions with pre-formed corners to provide for fixing.

03

SYSTEM OVERVIEW



Applications

Cemintel Territory can be installed as an internal feature wall solution suitable for all building classes.

Benefits of the Cemintel Territory System

- Low maintenance.
- No requirement for additional painting costs.
- Potential to speed up the construction process.
- Large format lightweight panels are designed to be fixed to industry standard timber or steel stud structural frames.
- Panels are easy to cut for openings eg. around windows and doors.
- Fire Resistance – has been assessed as a with a Material Group Number of 1-S after testing from BRANZ.

Product Specifications

A technical Data Sheet can be downloaded from cemintel.co.nz

Dimensional/Geometrical Characteristic	Specification	Manufacturing Tolerance	Relevant Standard
Panel Width	470mm (overall width) 455mm (effective coverage)	+ / - 1mm	JIS A 5422
Panel Length	3030mm	+ / - 1mm	JIS A 5422





DESIGN + AESTHETIC
CONSIDERATIONS

This section outlines some important areas for consideration in determining whether Cemintel Territory is suitable for the required application. The following points are not exhaustive. It is the responsibility of the Architect/building designer to ensure the design conforms to NZBC requirements and other relevant building standards that may exist for the location. This guide should be read in conjunction with the NZBC.

Face Fixings

Cemintel Territory is installed largely as a concealed fixing system. The panels are held in place by clips that are screwed to the frame. However, in some places, for example, around openings and corners where corner clips cannot be fixed, face fixed nails or screws may be used. A colour matched touch up paint is available to cover the nails or screws in this instance.

Window & Door Openings

Cemintel Territory is compatible with industry standard aluminium and timber framed windows.

Where Territory panels are used to line the inside of external walls, consideration needs to be given to the total depth of the wall, taking into account the 16mm thickness of the panel and the 5mm cavity created by the fixing system.

Corners

The system offers the choice of either pre-formed matching corners or metal corners. In many cases the metal corners are considered easier to install.

Coverage

A Cemintel Territory panel has a nominal width coverage of 455mm.

Note that the recommended minimum cut panel size is 100mm in length and 200mm in height. Anything under this will most likely result in cracking. **All cut panels must have exposed edges sealed to protect against moisture penetration.**

FIGURE 4.01 Panel Coverage Calculator
– Horizontal Installation

Territory Panel Rows (Height)	Coverage for Full Panels (mm nominal)
1	455
2	910
3	1365
4	1820
5	2275
6	2730
7	3185
8	3640
9	4095

FIGURE 4.02 Panel Coverage Calculator
– Vertical Installation

Territory Panel Rows (Width)	Coverage for Full Panels (mm nominal)
19	8645
18	8490
17	7735
16	7280
15	6825
14	6370
13	5915
12	5460
11	5005
10	4550
9	4095
8	3640
7	3185
6	2730
5	2275
4	1820
3	1365
2	910
1	455

Note: For vertical panels, the panels at external corners and wall junctions must be trimmed to form a square edge joint. This will reduce the coverage of the first and last panels in a wall.

DESIGN + AESTHETIC CONSIDERATIONS



Control Joints

Movement Control Joints

Control joints provided in the panel layout should be aligned with any movement control joints provided in the framing.

When undertaking building additions, a movement control joint must be installed at the junction of the existing framing and new framing. The cladding systems must be discontinuous at this joint.

When setting out panels, design consideration should be given to the location of joints to ensure that minimum panel lengths and heights are met.

Vertical Control Joints

Vertical sealant filled control joints are required at the end of each panel (at a maximum 3030mm spacings = full length panel), at junctions with pre-formed corners, and at other locations where the Territory wall adjoins another wall type to allow for differential movement (refer to 'Construction Drawings and Details' section). No additional vertical control joints are required.

Vertical joints in panels must be aligned and extend for the full height of continuous panelling, although additional joints may be placed over openings for ease of installation. As the joints are expressed and sealant filled, consideration to the positioning of joints is important for aesthetic reasons. Placing joints at sides or above openings, or the use of full height windows can reduce the visual impact of joints.

The quality of the sealed joints can impact the aesthetic finish, and care needs to be taken when applying the sealant. Refer to installation details for instructions on how to seal joints.

Structural

Framing and Substrate Options

Cemintel Territory can be fixed to timber or steel framing as well as to masonry substrates.

For timber and steel framing, the minimum requirement shall be in accordance with the following standards:

- NZS 3604 – Timber Framed Buildings.
- NZS 3404 – Steel Structures.
- AS/NZS4600 – Cold Formed Steel Structures.

It is critical that the frame is true and plumb. Industry best practice for frame tolerance is 5mm misalignment over 3000mm.

Note: depending on the chosen panel layout, double studs may be required in some locations. Refer to 'System Engineering' section.

Structural Bracing

Cemintel Territory panels are indirectly attached to the structural framing using clips and spacers. As a consequence, they are not designed to provide wall bracing.

Bracing must be provided in the structural framing with methods such as sheet or strap bracing. Where sheet bracing is used, the entire wall framing to be clad with Territory panels must be sheathed to maintain a uniform fixing plane. Note: window setout will be affected.

Other Design Considerations

Penetrations

The Territory system will accommodate services that are run through the framing. Any notches or holes formed must be considered in the framing design.

Renovations

When undertaking building renovations, remove all lining from the original wall framing. Ensure the condition of the framing is in accordance with current requirements and is as true and as plumb as possible (within accepted industry tolerance of 5mm misalignment over 3000mm).

Install additional framing and insulation as required.

Limitations

Territory is not recommended and not warranted for the following applications:

- Wet areas such as bathrooms.
- Fireplace cladding.
- Exposure to temperatures greater than 50°C.
- Fixing of tiles or other materials to the face of the panel.
- The face is painted.

The above listing is not intended to be comprehensive. If in doubt, please contact Cemintel.



COMPONENTS + ACCESSORIES

COMPONENTS + ACCESSORIES



Gemintel Territory Panels and Colour Matched Accessories

Product Name - NZ Stocked range	Panel (2 Pk)	Touch-Up Paint*	Primer	Pre-formed External Corner #
WOODLANDS Teak	140795	159051	128124	140798
WOODLANDS Grey Gum	472438	474625	128124	472456
WOODLANDS Ebony	140797	159052	128124	140800
WOODLANDS Jarrah Slats	472440	474628	128124	472458
WOODLANDS Kwila Slats	472441	474629	186527	472459
WOODLANDS Oaky Slats	472442	474630	128124	472460
QUARRY Urban Grey	128087	159040	128124	128114
QUARRY Concrete	151949	159040	128124	128114
QUARRY Mottled Rustic Brick	472444	474631	128124	472462
QUARRY Black Modern Brick	472446	474632	128124	472464
RIDGE Black	472454	474636	186527	472472
RIDGE White	472455	474635	128124	472473
CANYON Kings	472451	474641	128124	472469
CANYON Katherine	472452	474640	128124	472470
CANYON Carnavon	472450	474642	128124	472468
SAVANNA Cloud	128082	159034	128124	128088
SAVANNA Haze	128084	159035	128124	128111

Product Name - Indent Only Range	Panel (2 Pk)	Touch-Up Paint*	Primer	Pre-formed External Corner #
WOODLANDS Smoked	186444	186456	128124	186484
WOODLANDS Cedar	472434	474627	186527	472435
WOODLANDS Limed	186446	186458	128124	186486
WOODLANDS Birch	472439	474626	186527	472457
QUARRY Grey Rustic Brick	472445	474634	128124	472463
QUARRY White Rustic Brick	472443	474633	128124	472461
QUARRY Mosaic White	472448	474637	128124	472466
QUARRY Mosaic Ivory	472449	474638	128124	472467
QUARRY Mosaic Brown	472447	474639	186527	472465





*Touch-Up Paint – use for nail heads, cut edges at window heads and other visible blemishes.

If 304 nail heads require coating, use a primer for bare steel such as Dulux All Metal Primer prior to coating with the appropriate colour matched paint.

#Pre-formed External Corners are manufactured to match panels. Internal measurement – 70mm x 70mm. Coverage nominal 86mm x 86mm x 455mm.

Other Accessories/Tools

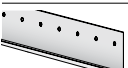

Note: To guarantee performance, only approved fasteners should be used in these systems. Where nominal fasteners are required, Class 3 minimum finish products must be used. Where nominal fasteners are required, Class 3 minimum finish products must be used.

Accessories	Description	Use*	Size/Colour	Quantity	Product Code
	Screws for Timber Framing – used to fix starter strip, clips and other components. Stainless steel 410 grade and clear coated.	ALL	35mm	250 per pack	128145
	Nails for Timber Framing – for fixing panels at soffit line and other locations where required. Ribbed shank, flat head, stainless steel 304 grade. Pre-drill panels for all nails.	ALL	75mm	115 per pack	128147
	Screws for Steel Framing – for face fixing panels at soffit line and other locations where required. Class 3, self-drilling, CSK self-embedding head, Phillips drive. Suitable for minimum 0.75mm BMT steel framing.	ALL	55mm	250 per pack	128149
	Screws for Steel Framing – for fixing starter strip, clips and other components. Class 3, 8g, self-drilling, button head, Phillips drive.	ALL	20mm	100 per pack	128148
	Internal Horizontal Starter Strip – steel profile used at the base to locate the first row of panels. Provides 5mm offset from face of studs. Manufactured from 1.2 BMT steel with galvalume AZ150 corrosion resistant coating.	H	3030mm	1 each	132364

05

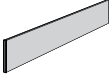
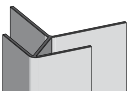

COMPONENTS + ACCESSORIES

Note: Codes can change from time to time. Refer to the website for the current list of components prior to ordering.



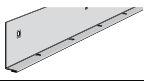

	5mm Panel Clip – fixed to the framing to retain the tongue and groove edges of panels. Manufactured from SuperDyma corrosion resistant coated steel. Installed horizontally for horizontal applications and vertically for vertical applications.	ALL	60mm x 45mm x 5mm	50 per pack	132365
	5 x 45 x 45mm Self Adhesive Spacer – for use where small segments of spacer are required.	ALL	5 x 45 x 45mm segments 1000mm	1 each	132363
	External Metal Corner Trim – anodised aluminium extrusion used to dress and finish external corners. 60mm x 65mm x 3030mm	ALL	Silver	1 each	128117
	Backing Rod – used to enable correct filling of some joints with sealant. The diameter of the backing rod must be appropriate for the width of the gap being filled.		10mm dia. x 50m roll	1 each	Supplied By Others
	Cemintel Edge Sealer – for sealing panel edges after on-site cutting.		200ml	1 each	186529

* H refers to components for horizontal installation. V refers to components for vertical installation. ALL refers to components for both horizontal and vertical installation.

For Vertical Installations, the following additional components are required:

	Internal Vertical Starter Strip – steel profile used at the base to support the first row of panels. Manufactured from 1.2mm BMT steel with galvalume AZ150 corrosion resistant coating	V	2000mm	1 each	128963
	5 x 90mm Vertical Spacer – for packing between battens and panels at corners and other locations where face fixing is required. Manufactured in extruded plastic.	V	5mm x 90mm x 2000mm	1 each	128996

Tools

Product	Description	Size	Quantity	Product Code
	Cemintel Power Saw Blade – specifically designed for cutting pre-finished cement based sheets. Ideal for use with dustless circular saws fitted with vacuum extraction systems. 15000 RPM max.	125mm	1	154461
	Makita Plunge Saw Kit (1300W) includes 1400mm guide rail and bonus 165mm fibre cement saw blade – excellent for cutting cement based sheets	165mm	1	Supplied by others
	Makita 165mm Fibre Cement Saw Blade – ideal for use with the Makita Plunge saw and other 165mm circular saws fitted with vacuum extraction systems	165mmx20x4T	1	Supplied by others
	FESTOOL DSC-AGP 125 – Diamond Blade Cutting and Grinding Tool. Used to provide neat and accurate bevelled edges	125mm	1	Supplied by others
	FESTOOL TS 55 EBQ Plunge Cut Saw – with 1400mm Guide Rail. Precise plunge cuts in materials up to 55mm thick.	160mm	1	Supplied by others
	FESTOOL Diamond Tipped Blade for TS 55 – for cutting all fibre cement sheet products	160mm	1	Supplied by others



SYSTEM ENGINEERING



SYSTEM ENGINEERING

Design, Detailing And Performance Responsibilities

Cemintel engages independent testing laboratories to test and report on the performance of a wall in accordance with the relevant New Zealand Standards. Consultants use these reports as the basis for opinions (estimates of laboratory performance) they issue for variations to the tested system. Using their experience, the consultant will make judgement about on-site installed performance of various walls. The performance levels of walls documented in this guide are either what is reported in a test or the documented opinion of consultants. Performance in projects is typically the responsibility of:

Project Consultants (Structural, Fire, Acoustic, Etc.)

These consultants are typically responsible for the following:

- Opinions on expected laboratory performance of wall configurations that vary from actual test configuration, such as substitution products and components.
- Judgements about expected field performance using laboratory test reports and practical experience.
- Design, specification and certification of structural, fire, acoustic, durability, weather tightness and any other required performance criteria for individual projects.

This involves the design and selection of building elements, such as wall and floors and their integration into the building considering the following:

- Interface of different building elements and to the structure / substrate.
- Wall and floor junctions.
- Penetrations.
- Flashing design.
- Room / building geometry.
- Acoustic and water penetration field-testing.

Project Certifier and/or Builder

These professionals are typically responsible for:

- Identifying the performance requirements for the project in accordance with the NZBC and clearly communicating this to the relevant parties.
- Applicability of any performance characteristics supplied by Cemintel NZ including test and opinions for the project.
- The project consultant's responsibilities detailed above if they are not appointed.

Cemintel NZ does not provide consulting services. Cemintel only provides information that has been prepared by others and therefore shall not be considered experts in the field.

Any party using the information contained in this guide or supplied by Cemintel in the course of a project must satisfy themselves that it is true, current and appropriate for the application, consequently accepting responsibility for its use.

It is the responsibility of the architectural designer and engineering parties to ensure that the details in this design guide are appropriate for the intended application.

The recommendations in this guide are formulated along the lines of good building practice, but are not intended to be an exhaustive statement of all relevant data.

Cemintel NZ is not responsible for the performance of constructed walls, including field performance, and does not interpret or make judgements about performance requirements in the NZBC.

05

INSTALLATION

07

INSTALLATION

CHECKLIST – Prior to Installation

The following pre-install checklist may assist to ensure you have the best possible outcome when using Cemintel Territory.

- Ensure substrate is straight and plumb. Pack studs to straighten if necessary (timber frames as per NZS3604, steel frames as per AS/NZS4600 or NZS3404). Industry best practice for frame tolerance is 5mm misalignment over 3000mm.
- Ensure studs are correctly located and of the appropriate thickness.
- Confirm bracing is in place. Where sheet bracing is used behind panels, the entire wall area needs to be braced or bracing sheet packers fixed to the frame to ensure a uniform fixing plane.
- Confirm your panel layout to determine the location of joints and identify where additional studs are required at all short edge joints and internal and external corners.
 - If using pre-formed corners, studs need to be located to allow fastening of corner clips to support the corners.
 - Additional studs or blocking may be required for support and fixing of Territory joint backing strips at corners and junctions.
- Confirm appropriate window detailing to accommodate Territory panel set out (taking into account the 16mm panel thickness and 5mm cavity created by the clips, spacers etc).
- Where there is no space to use a mounting clip along the bottom and top edge of the window, tack a horizontal green spacer to provide a firm surface for the cladding panel to maintain its position.
- Confirm the detailing for the base, head and end of wall junctions.
- Confirm services and insulation have been installed in framing where appropriate.
- Confirm adequate structural support for fixtures such as shelving, signage etc.



Check quality and quantity of panels and components before installing. If there is any sign of damage or visible defects in panels, or the colour/finish is not in keeping with the owners aesthetic requirements DO NOT INSTALL. Contact Cemintel to address any issues.



Horizontal Installations – Clips on Stud Fixing Installation Set-Out

Timber and Steel Framing

All framing must be in accordance with the following NZS 3604 for timber framing or NZS 3404 or AS/NZS 4600 for steel framing.

Studs are to be installed at 600mm maximum centres. Double studs are required at all panel end joints.

FIGURE 7.01 Typical Framing Set-Out with 70mm Timber or Steel Framing and Pre-formed Corner – Plan View

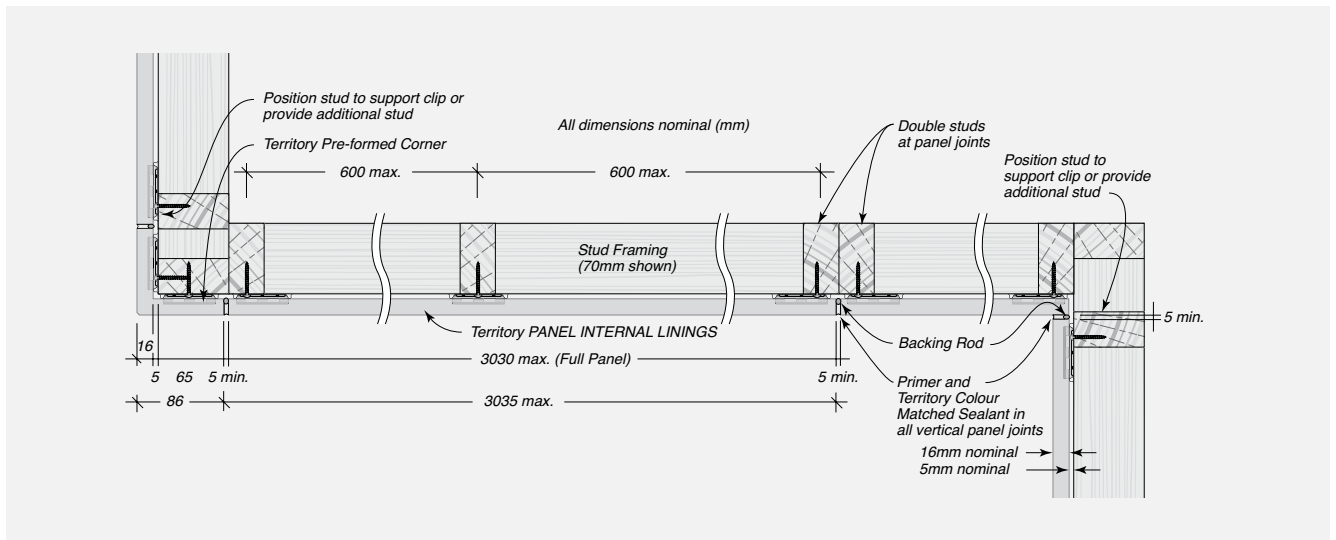
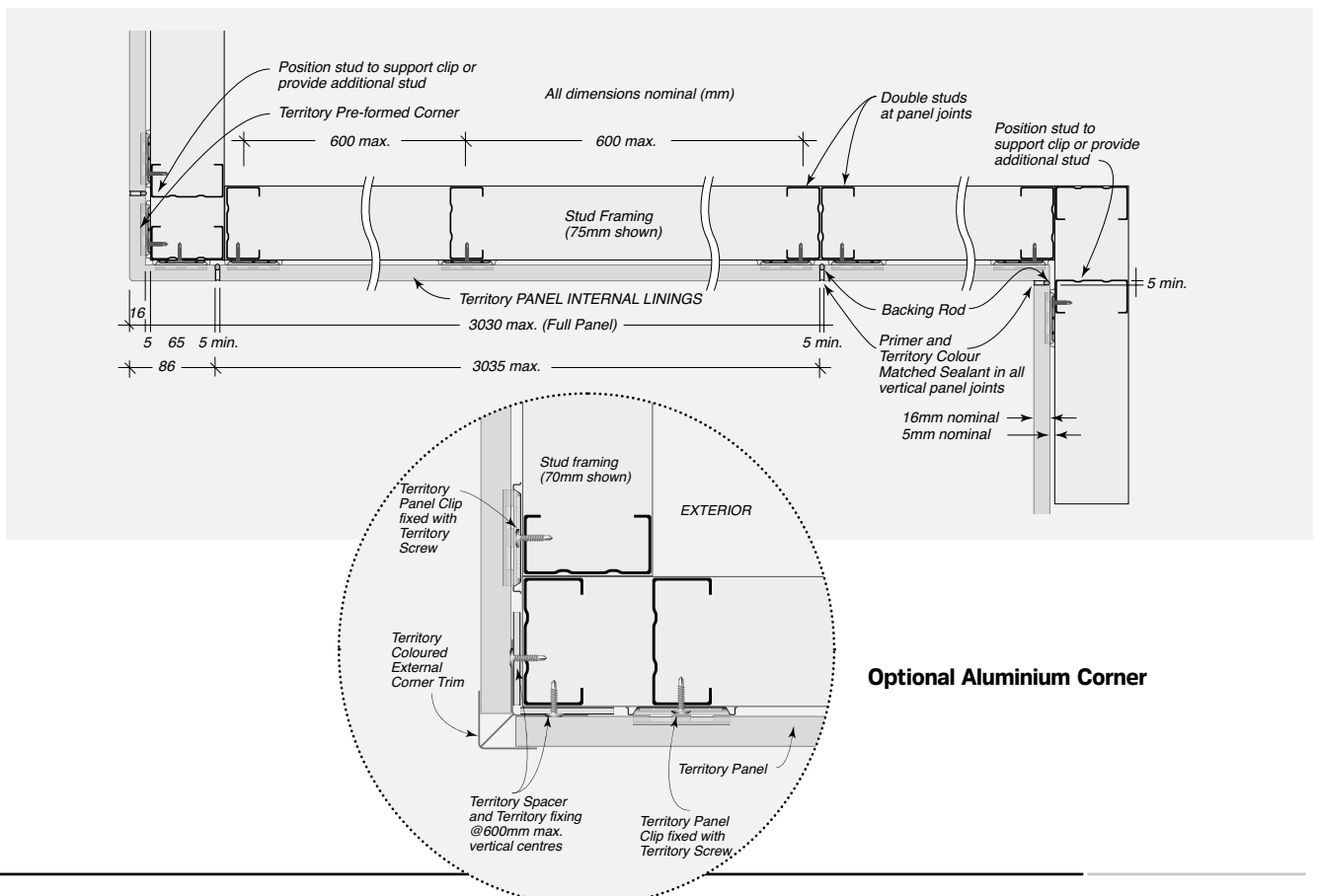
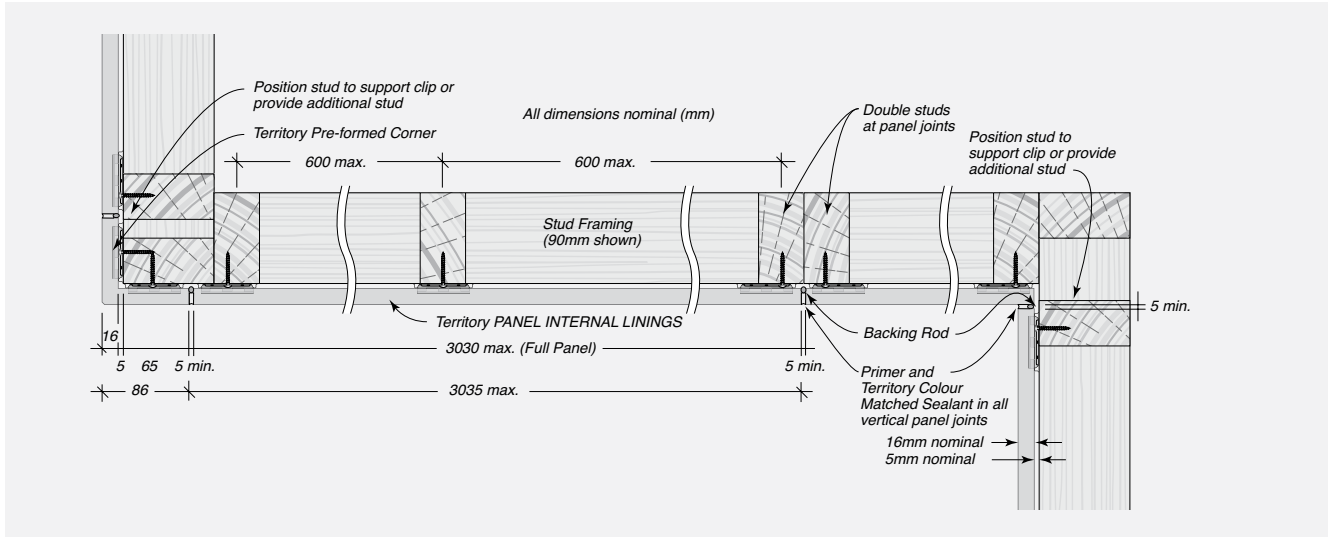

FIGURE 7.02 Typical Framing Set-Out with 75mm Steel Framing and Pre-formed Corner – Plan View



Steel Framing

FIGURE 7.03 Typical Framing Set-Out with 90mm Timber or Steel Framing and Pre-formed Corner - Plan View

INSTALLATION



FIGURE 7.04 Typical System Cross Section - Elevation

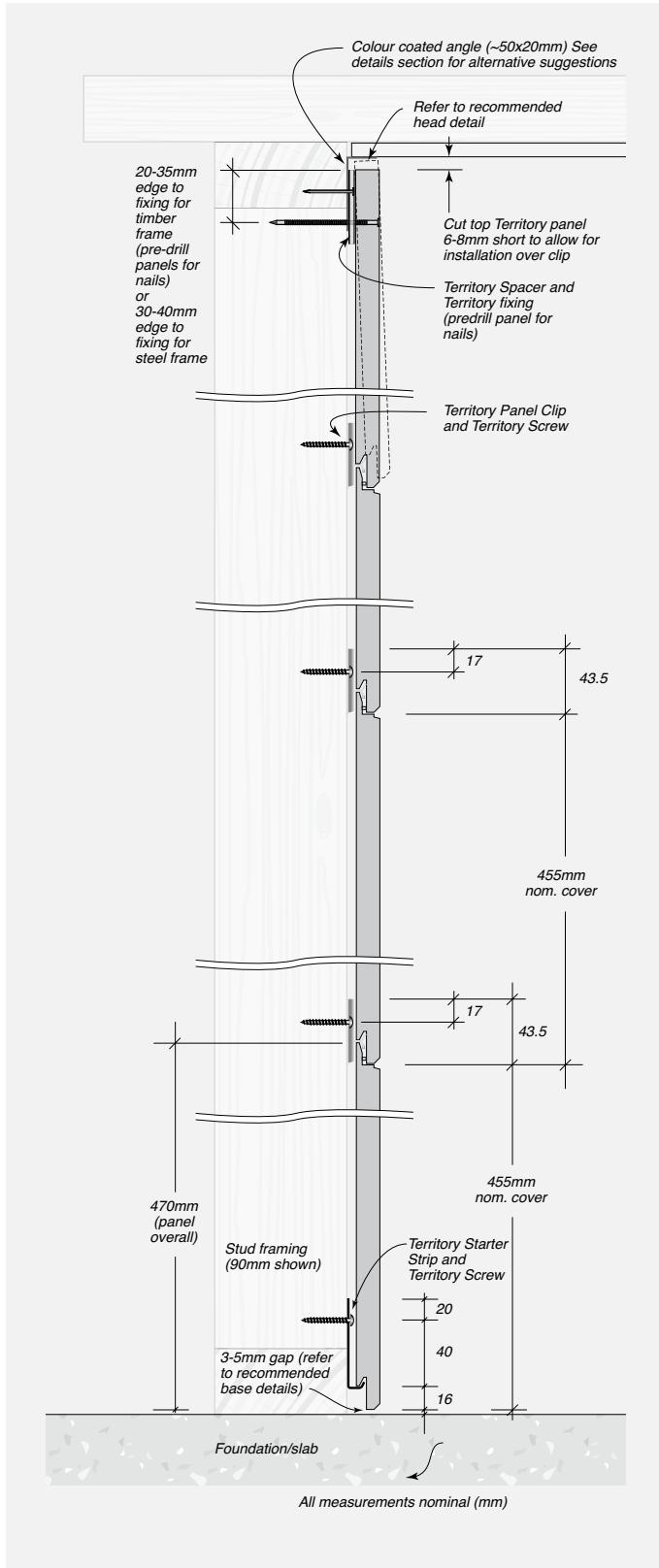

FIGURE 7.05 Typical System Cross Sectional Detail where Face Fixing is required - Timber Frame - Elevation

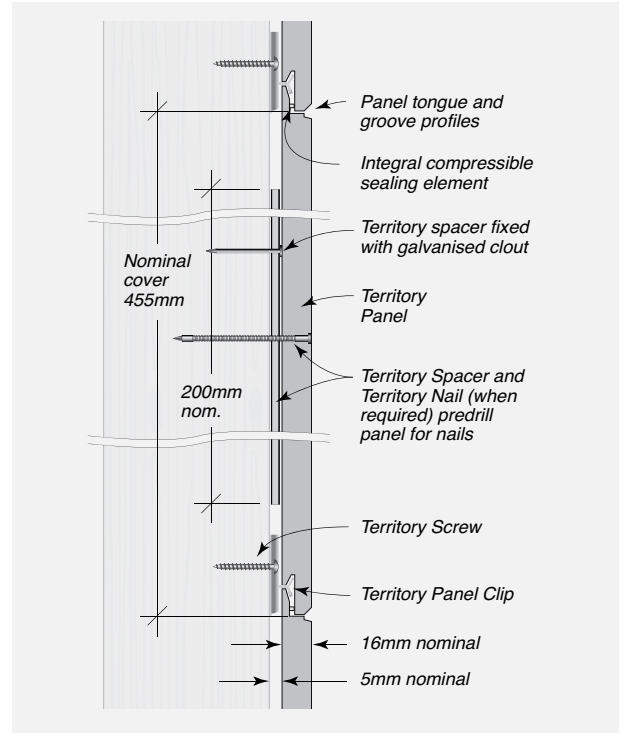
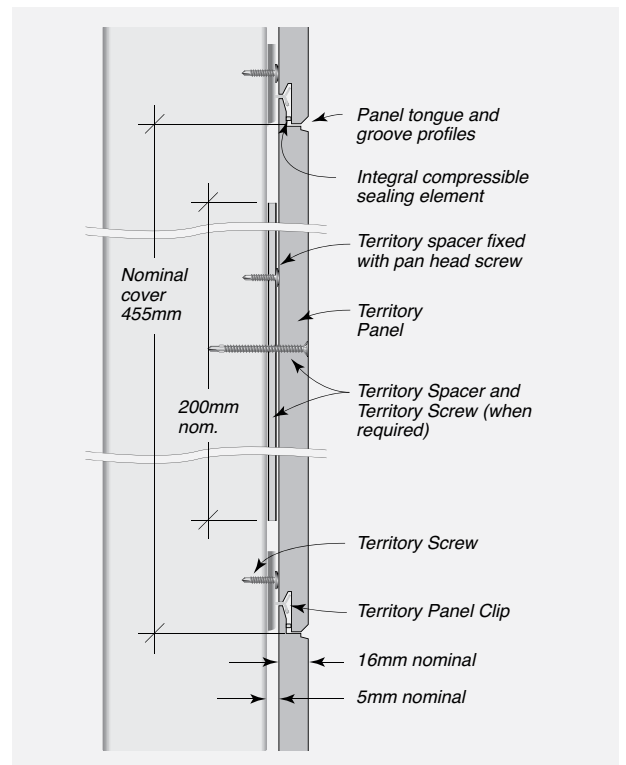

FIGURE 7.06 Typical System Cross Sectional Detail where Face Fixing is required - Steel Frame - Elevation



07

INSTALLATION

Horizontal Installation

Step 1 – Install horizontal starter strip to the base of the wall. Measure to allow for the 16mm overhang of the panel when it sits on the starter strip. Screw the starter strip level along the whole length of the strip to the base plate/studs. Because each panel sits on top of the other, any errors in setting the level on the first wall panel will be compounded through each layer. It is therefore critical to ensure the starter strip is fitted level, ready to accept the first panel.

Step 2 – Install Corners (note if no external corner exists start installing panels at one end of the wall).

- A.** If installing pre-formed corners, slide the first corner piece down the corner and over the starter strip. Then insert a panel clip on each side and screw to the stud. It is important to ensure that each corner piece is square on both sides. If the corners are not square, pack out the clips. To add the next corner piece, slide it on top so that it sits firmly on the clips and tap into position. Secure another set of clips to the top of the panel and screw fix to framing.
- B.** If installing aluminium corners, cut to length. Notch out to extend over the starter strip. To maintain the 5mm cavity, first tack vertical spacers on each side of the corner stud. Then, ensuring the metal corner is correctly positioned, nail or screw it through the spacer to the frame. The wall panel should fit into the corner trim channel and slide down onto the starter strip.

Step 3 – Install wall panels. Place the first wall panel over the starter strip and slide into place. Position panel clips at every stud and screw into place. Pack out the clips if necessary to ensure a uniform fixing plane. Continue to install the first row of panels horizontally onto the starter strip. Use tile spacers or similar to form a 5mm gap at all panel end vertical joints. Ensure vertical joints are accurately aligned. Continue to secure clips to the top (tongue) of the panel, tap firmly into place and screw fix to framing.

Where face fixing may be required, a strip of horizontal spacer (or cut to a minimum length of 200mm) should be positioned between the panel and the frame thus maintaining the 5mm cavity.

Step 4 – Finishing at the wall head. Determine appropriate head detail. If installing a metal angle, install prior to fixing panel. At the wall head face fixing is required. Install horizontal spacer strip behind all panel fixing points to maintain the 5mm cavity. Cut the top panel/pre-formed corner 6-8mm shorter than the height of the wall to allow lifting of the final panel and dropping into place. Mark the position of the studs to identify fastening points. Predrill fastener holes. Fasteners should be located 20-35mm from panel edges for timber frames or 30-40mm for steel frames.

Tilt the panel out at the bottom, lift panel up and locate the bottom edge of the panel onto the clips already installed. Once firmly in place, fasten panels to the studs using the Cemintel supplied face fix fasteners.

Step 5 – Caulk all expansion joints (ref Fig. 7.07). Ensure panels are dry before applying primer and sealant. Install backing rod into vertical joints. Apply masking tape to each side of the vertical joints and at the base. Paint the edges of the panels with the primer. This helps the sealant adhere to the panels. Wait at least 30 minutes but no more than 6 hours to apply the sealant. Smooth off the finish by removing excess sealant. Carefully remove masking tape in accordance with manufacturer's instructions. **CARE NEEDS TO BE TAKEN NOT TO GET SEALANT ON PANELS** as this can result in marks and stains. Install sealant to gaps at windows and other penetrations.

Step 6 – Touch up any exposed fasteners. Wipe panels down with a damp cloth and touch up any exposed nail or screw heads with matching touch up paint.

FIGURE 7.07 Typical Method for Sealing Vertical Joints

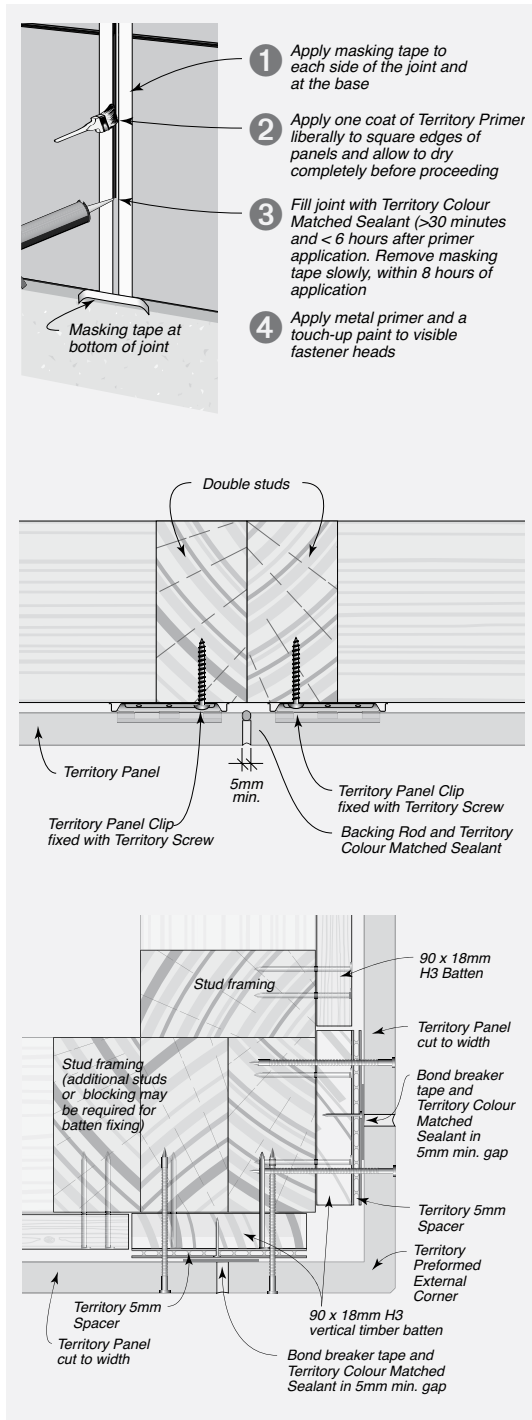

07

INSTALLATION

- 1 Stud (double for vertical joints)
- 2 Horizontal Starter Strip
- 3 Pre-formed horizontal corner
- 4 Panel
- 5 Panel clip
- 6 Backing rod
- 7 Primer and sealant
- 8 Horizontal Spacer strip

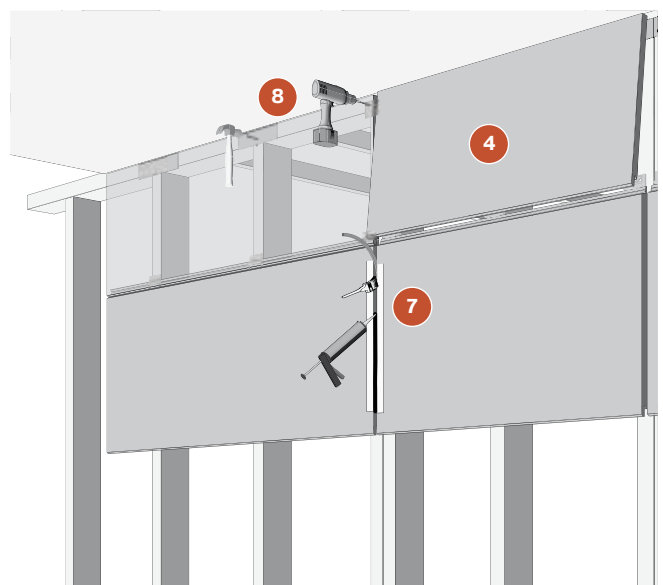
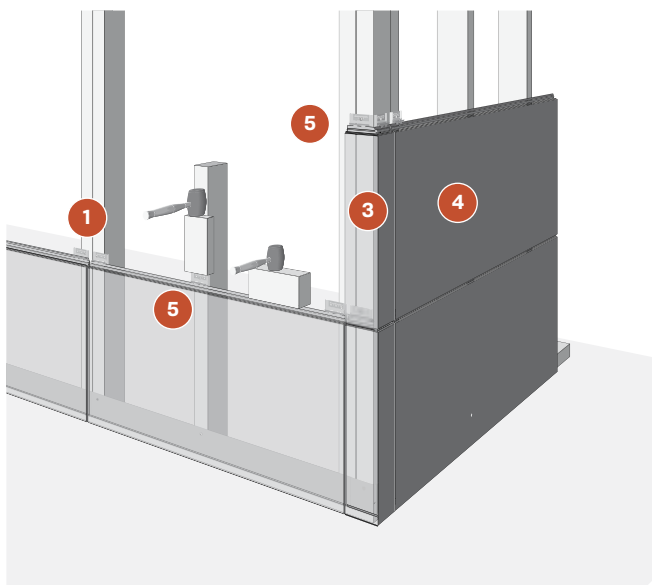
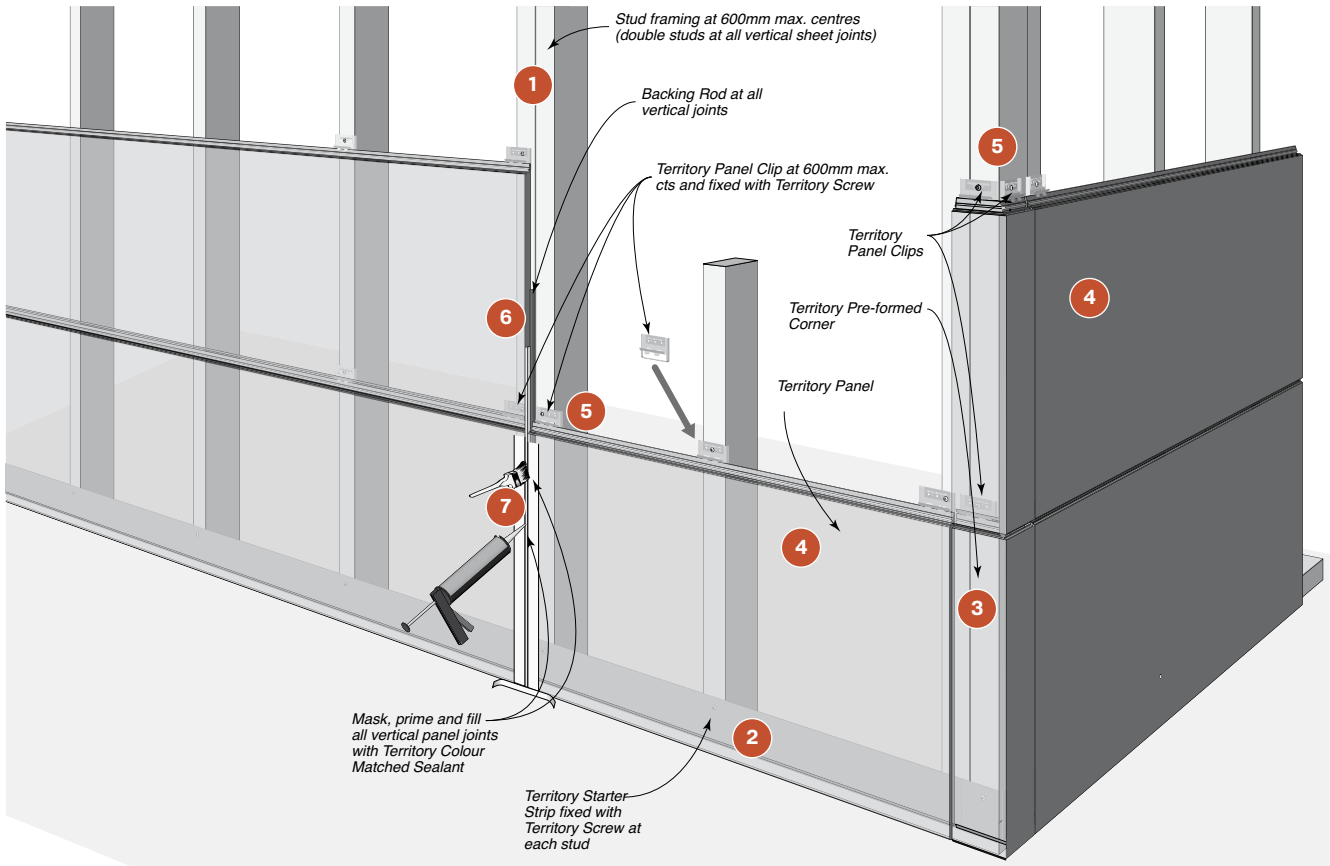

Vertical Installation – Clips on Batten Fixing Installation Set-Out

Timber and Steel Framing

All framing must be in accordance with the following AS1684 – Residential Timber-Framed Construction.

The Territory Vertical Panel on-batten system is detailed here with 90mm x 18mm timber battens. Battens must be spaced at 600mm maximum centres, and fixed with two nails or one screw to each stud.

Battens may be aligned or offset.

Aligned battens may require additional blocking or studs to allow landing and fixing of batten ends (ref Fig 7.06).

FIGURE 7.08

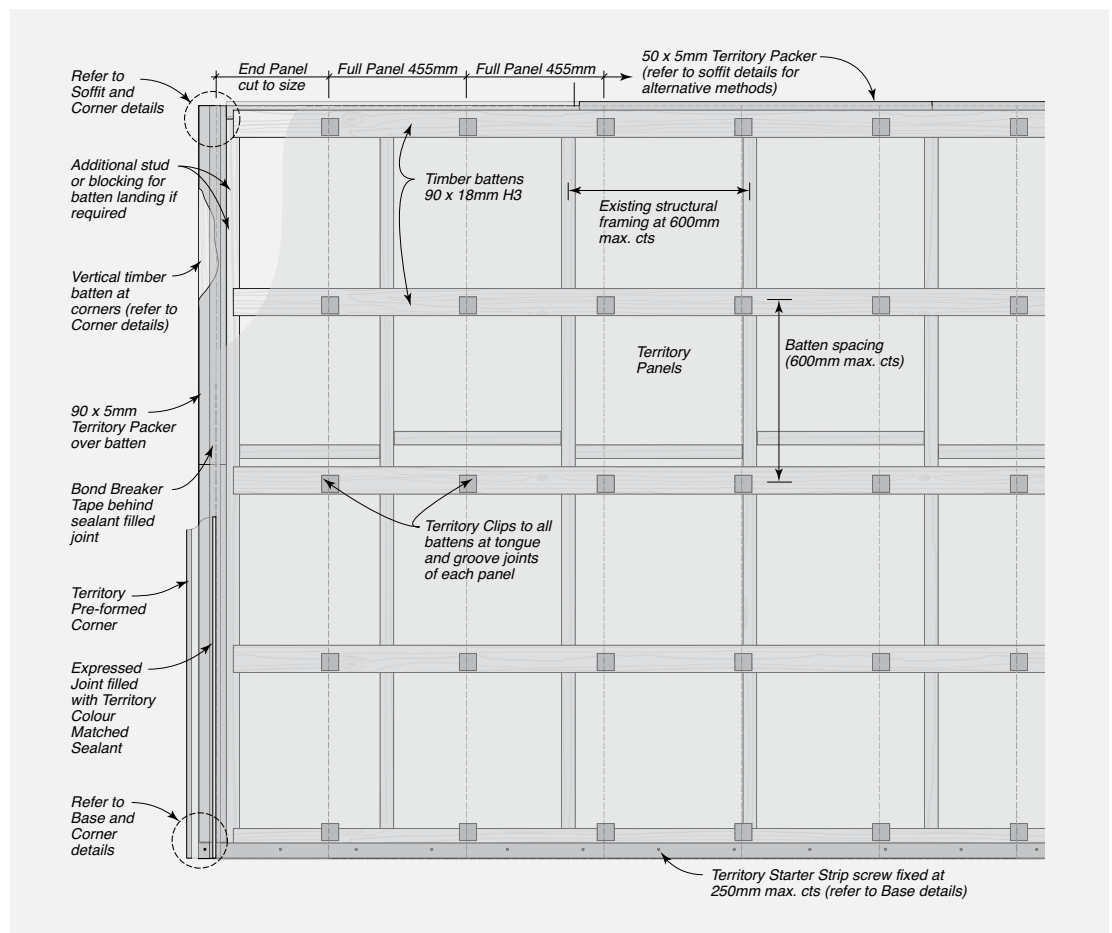

07

INSTALLATION

Panel Layout and Fixing

Vertical panel installation requires a square edge to the panel at junctions with a Territory pre-formed Corner or Metal Corner Trim, at internal corners and at junctions with masonry or other wall systems. This requires removal of the tongue or groove from one edge of the end panels. These panels can be trimmed to between 200mm and 430mm nominal cover. These panel widths should be considered when panel joint location is important for aesthetics (ref Fig 7.07 and 7.08).

All face fixings must be backed and supported by the Territory vertical spacer.

Panels must be fixed to the structural framing along trimmed edges with 75mm nails at 20-35mm from the panel edge for timber framing (or with Territory 55mm screws at 30-40mm from the panel edge for steel framing) and at spacings aligned with adjacent battens (ref Fig 7.12).

All other panel joints require the factory finished tongue and groove for fixing with panel clips. Clips are to be fixed to battens with 20mm button head screws. One screw may be used in the clips at the wall head and base. Two screws must be used in all other panel clips.

FIGURE 7.09 Non-symmetrical Panel Set-Out

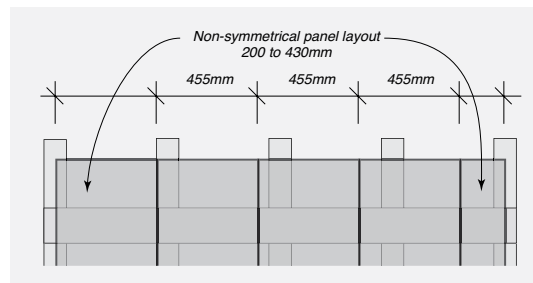

FIGURE 7.10 Symmetrical Panel Set-Out

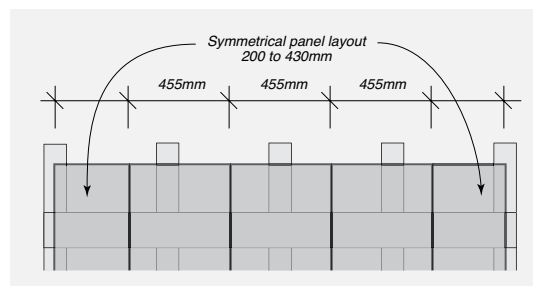
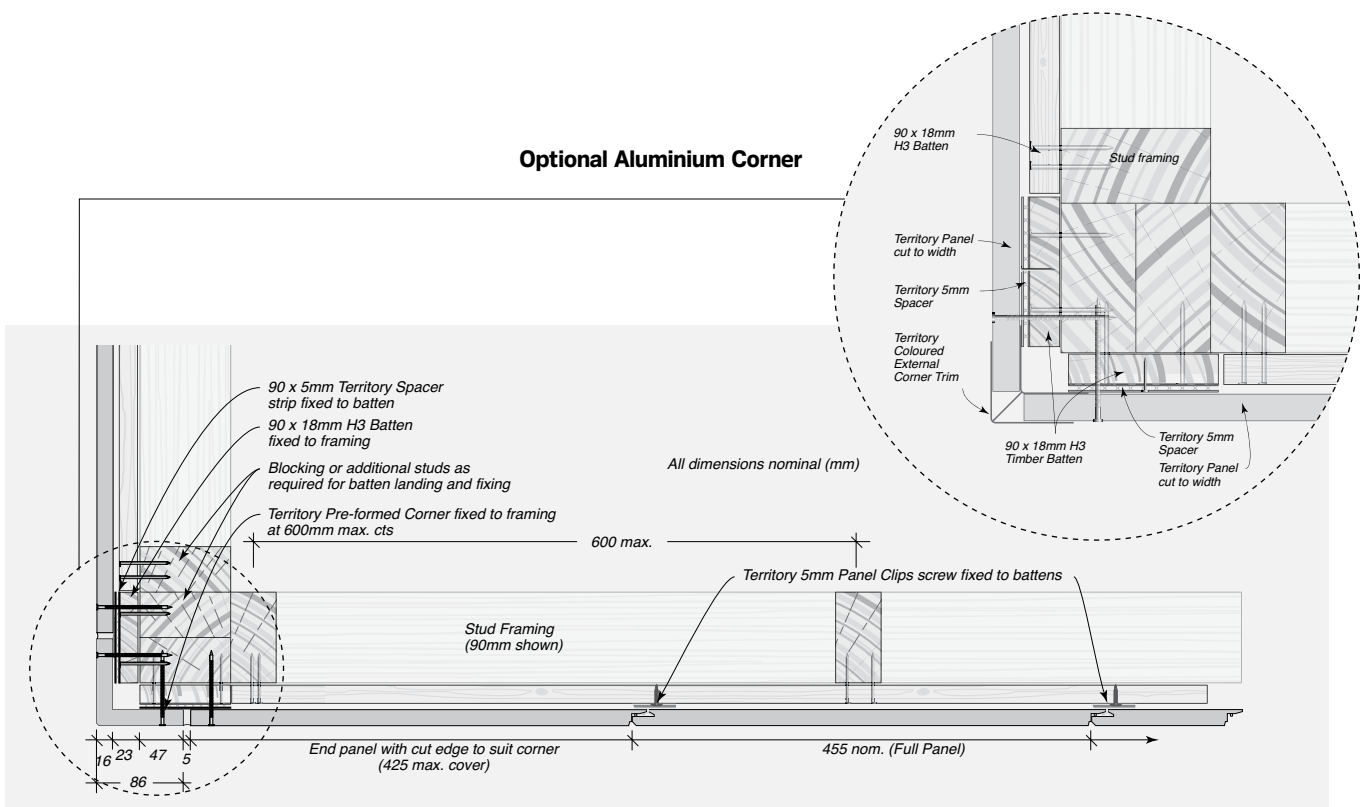

FIGURE 7.11 Typical Framing Set-Out with 90mm Timber or Steel Framing and Pre-formed Corner – Plan View



INSTALLATION



FIGURE 7.12 Typical Framing Set-Out with 70mm Timber Framing and Territory Pre-formed Corners – Plan View

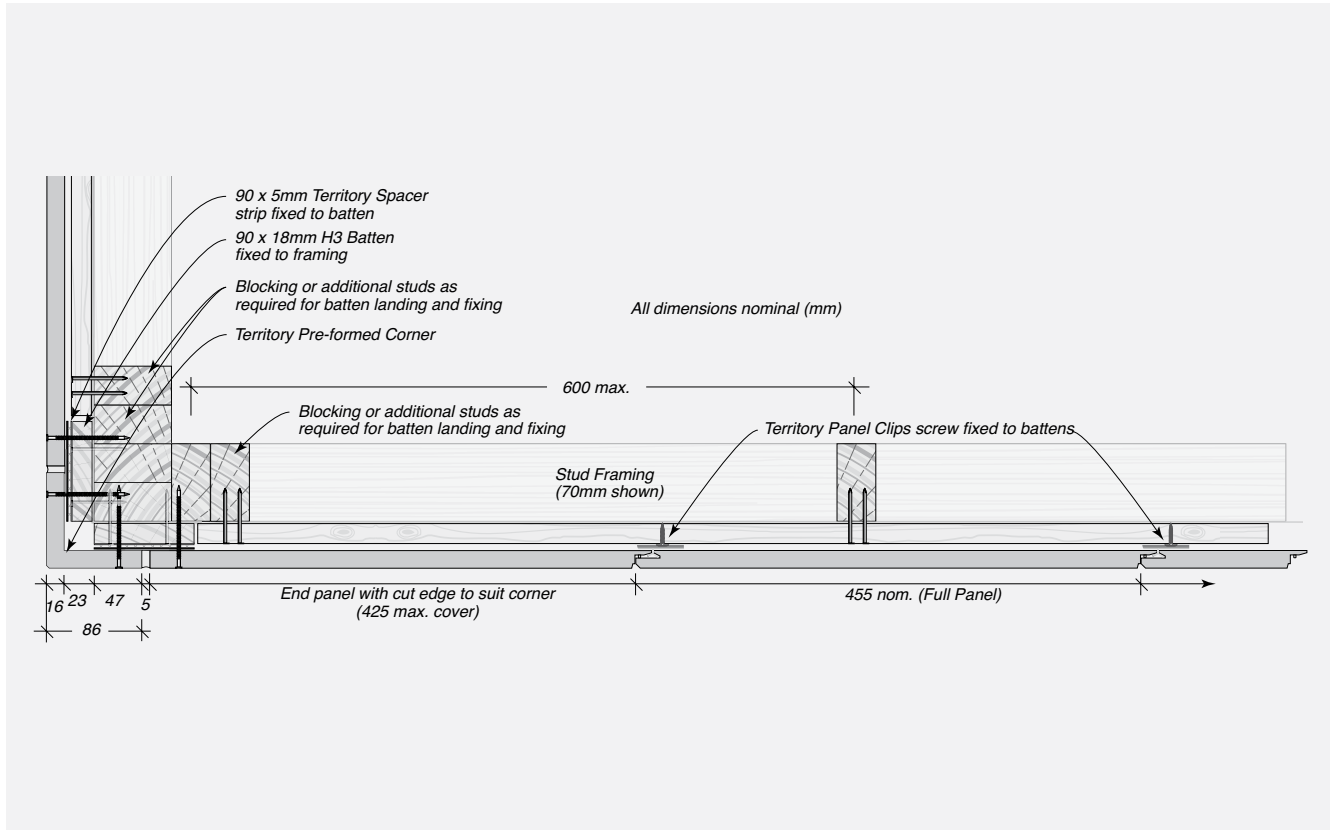

07

INSTALLATION

FIGURE 7.13 Typical Territory System Cross Section - Elevation

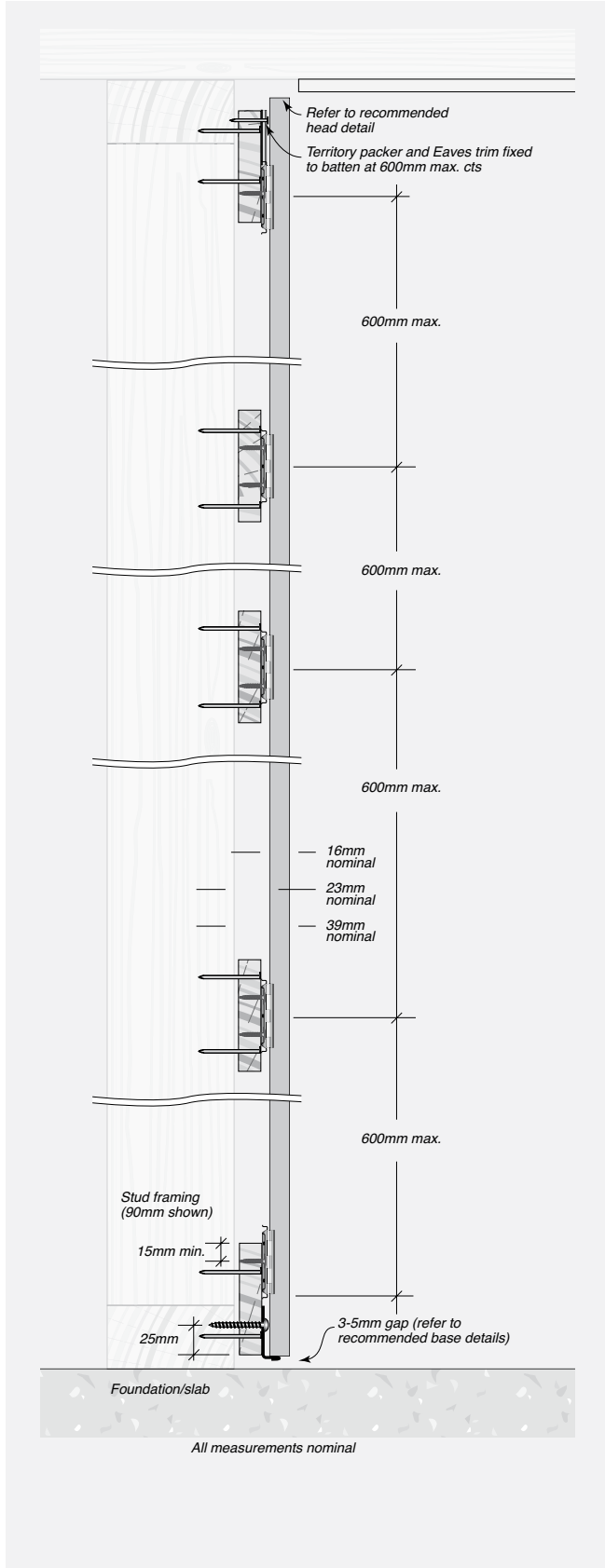
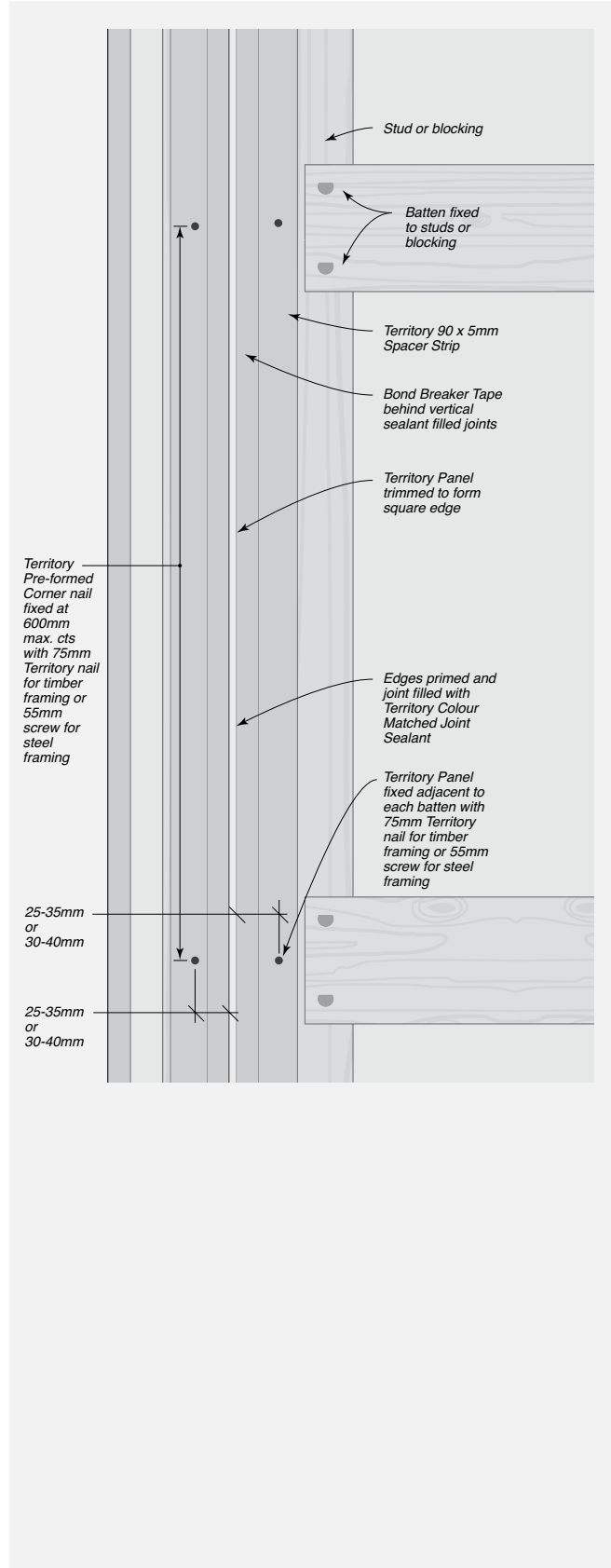

FIGURE 7.14 Typical Face Nailing at Square Edge Joint - Elevation



Vertical Installation

Step 1 – Install Battens. Install horizontal battens to studs with 2 nails or 1 screw (additional blocking/studs may be required). Install vertical battens to studs with 2 nails or 1 screw at all corners and where Territory panels abut other wall types.

Step 2 – Install vertical starter strip to the base of the wall. Ensure there will be a minimum 3-5mm clearance between the floor surface and bottom of the panels. Fasten the starter strip level along the whole length of the strip to the bottom plate at 250mm maximum centres.

Step 3 – Prepare corners. Install 5mm vertical spacer strip to vertical corner battens and install bond breaker tape for vertical joints that require sealant filling. The 5mm spacer is required at all face fixing locations (including corner joints). Note that, if backing rod is required, install after panel installation.

Step 4 – Install Corners (note if no external corner exists start installing panels at one end of the wall).

- A.** If installing pre-formed corners, place the first corner piece at the corner onto the starter strip. It is important to ensure that each corner piece is square on both sides. If the corners are not square, pack out the clips. Pre-drill holes into the corner piece and the adjoining panel allowing 20-35mm (or 30-40mm for steel) clearance from the edge. Fix through the batten and 5mm spacer with appropriate fasteners.
- B.** If installing aluminium corners, cut to length. Notch out to extend over the starter strip. To maintain the 5mm cavity, first tack vertical spacers on each side of the corner stud. Then, ensuring the metal corner is correctly positioned, nail or screw it through the spacer to the frame. The wall panel should fit into the corner's channel and slide down onto the starter strip.

Step 5 – Install wall panels. Place the first wall panel onto the starter strip. Position panel clips to tongue and groove edge of panels at every horizontal batten. Tap firmly into place and screw into place using 20mm Territory button head screws. Use 1 screw for head and base clips and 2 screws for all other clips. Pack out the clips if necessary to ensure a uniform fixing plane.

Continue to install the panels onto the starter strip. Continue to secure clips to the tongue of the panel, tap firmly into place and screw fix to battens. Where face fixing may be required, a strip of Spacer (cut to a minimum length of 200mm) should be positioned between the panel and the frame thus maintaining the 5mm cavity.

Step 6 – Finishing at the wall head. Determine appropriate head detail. If installing a metal angle, install prior to fixing panel. Install spacer strip onto the top horizontal batten to maintain the 5mm cavity. Cut the top panel/prefinished corner 6-8mm shorter than the height of the wall to allow lifting of the final panel and dropping into place.

Step 7 – Caulk all expansion joints (ref Fig 7.13). Ensure panels are dry before applying primer and sealant. Ensure bond breaker tape or backing rod is installed at vertical joints. Apply masking tape to each side of the vertical joints and at the base. Paint the edges of the panels with the primer. This helps the sealant adhere to the panels. Wait at least 30 minutes but no more than 6 hours to apply the sealant. Smooth off the finish by removing excess sealant. Carefully remove masking tape in accordance with manufacturer's instructions. CARE NEEDS TO BE TAKEN NOT TO GET SEALANT ON PANELS as this can result in marks and stains. Install sealant to gaps at windows and other penetrations.

Step 8 – Touch up any exposed fasteners. Wipe panels down with a damp cloth and touch up any exposed nail or screw heads with matching touch up paint.

FIGURE 7.15 Typical Method for Sealing Vertical Joints

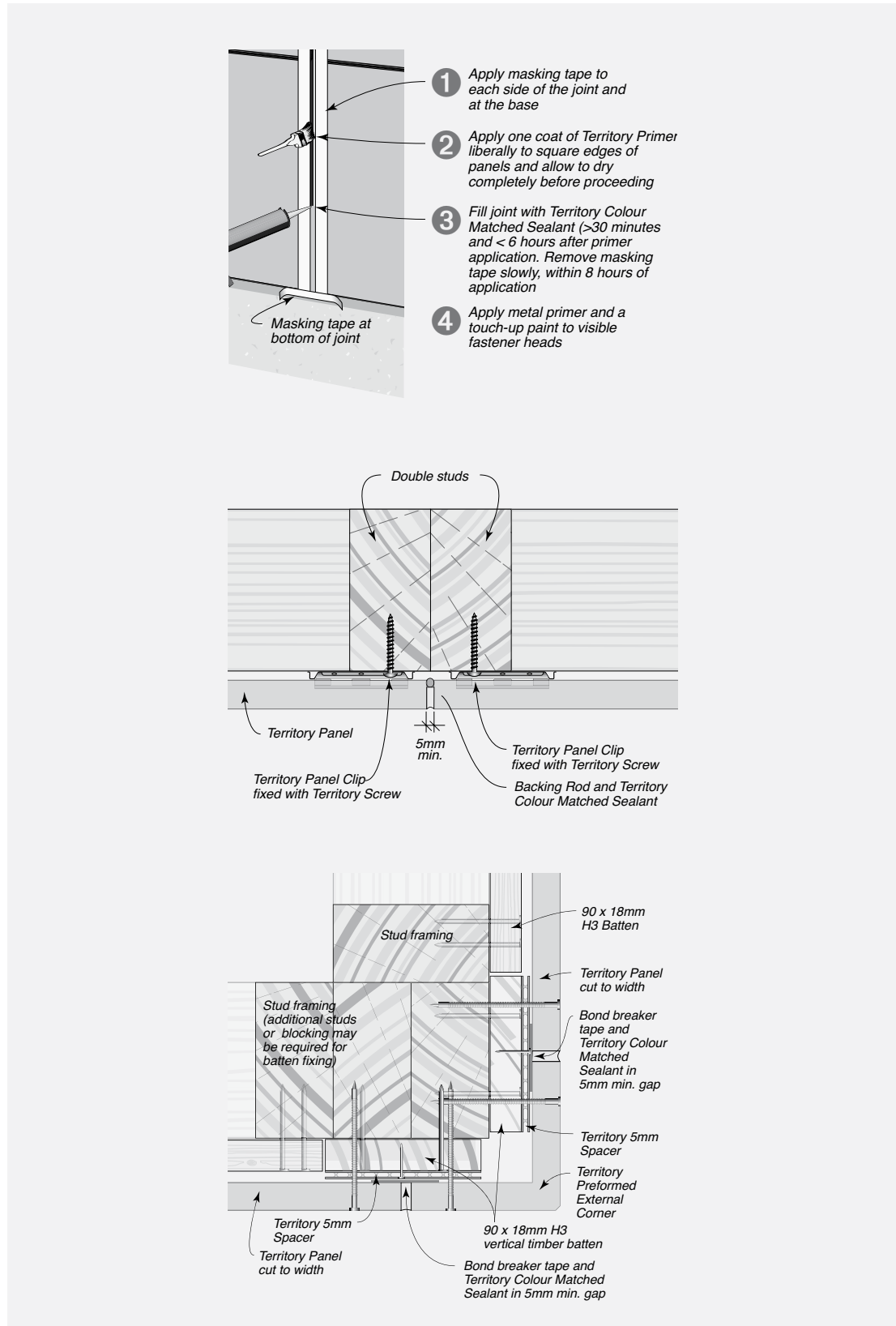

INSTALLATION



- 1 Stud
- 2 90x18mm timber horizontal battens
- 3 90x18mm timber vertical battens
- 4 Vertical starter strip
- 5 Vertical spacer strip
- 6 Bond breaker tape or backing rod
- 7 Pre-formed vertical corner
- 8 Panel
- 9 Panel clip
- 10 Primer and sealant
- 11 Face fixing

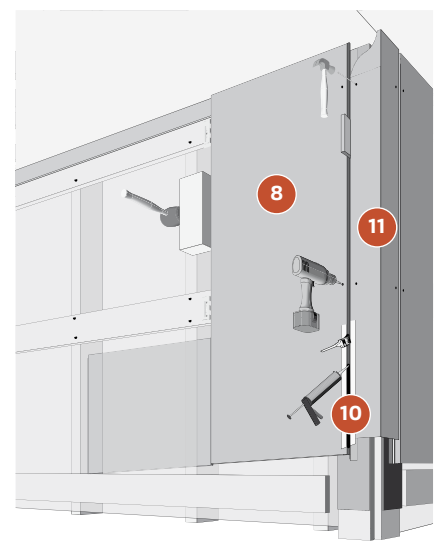
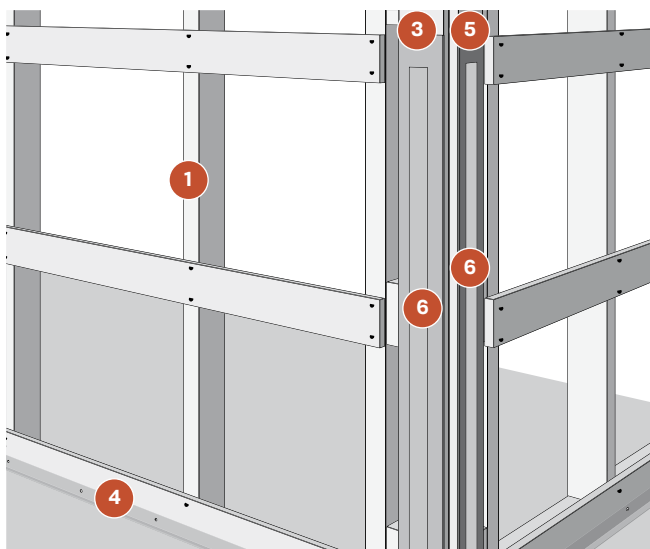
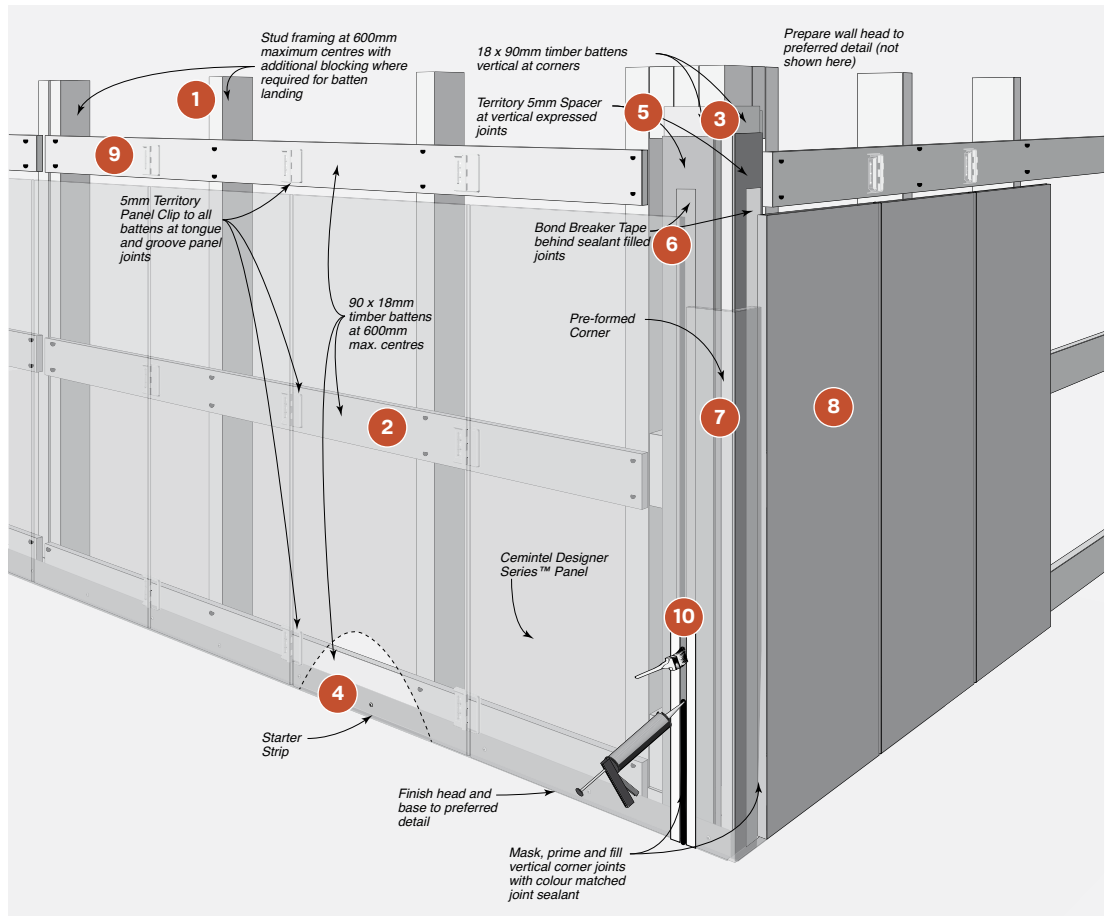



CONSTRUCTION
DRAWINGS + DETAILS

CONSTRUCTION DRAWINGS AND DETAILS



Note: Drawings are interchangeable for timber or steel substrates with the exception of the fasteners.

Drawings Index

SECTION	DESCRIPTION	FIGURE REFERENCE	PAGE NUMBER
HORIZONTAL INSTALLATION			
Base Details	Base Detail – No Skirting	8.01	34
	Base Detail – With Skirting	8.02	34
Head Details	Head Detail - With Coloured Angle	8.03	34
	Head Detail - With Cornice	8.04	34
	Preformed External Corner – Plan View	8.05	35
	Internal Corner with Backing Rod and Colour Matched Sealant – Plan View	8.06	35
	External Corner with Coloured External Corner Trim – Plan View	8.07	35
Junction Details	Obtuse Angle Corner with Metal Flashing and Colour Matched Sealant – Plan View	8.08	35
	Typical Junction with Plasterboard Wall – Plan View	8.09	36
	Typical Junction with Masonry Wall – Plan View	8.10	36
	Typical Junction with Deep Masonry Wall – Plan View	8.11	36
VERTICAL INSTALLATION			
Base Details	Base Detail - With Sealant	8.12	37
	Base Detail – with Skirting	8.13	37
Head Details	Head Detail - With Sealant	8.14	37
	Head Detail - With Cornice	8.15	37
Corner Details	External Corner Detail – With Preformed Corner – Plan View	8.16	38
	Internal Corner Detail – With Backing Strip and Colour Matched Sealant – Plan View	8.17	38
	External Corner Detail – With Coloured External Corner Trim – Plan View	8.18	38
	Obtuse Angle Corner Detail – With Metal Flashing and Colour Matched Sealant – Plan View	8.19	38
Junction Details	Junction with In-line Masonry Wall – Plan View	8.20	39
	Typical Detail Junction with Fibre Cement Cladding System – Plan View	8.21	39



CONSTRUCTION DRAWINGS AND DETAILS

Note: Drawings are interchangeable for timber or steel substrates with the exception of the fasteners.

Horizontal Installation

Base Details

FIGURE 8.01 Base Detail - No Skirting

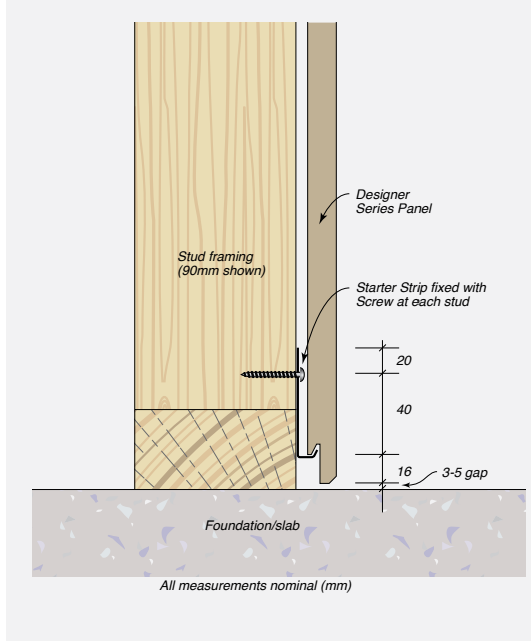
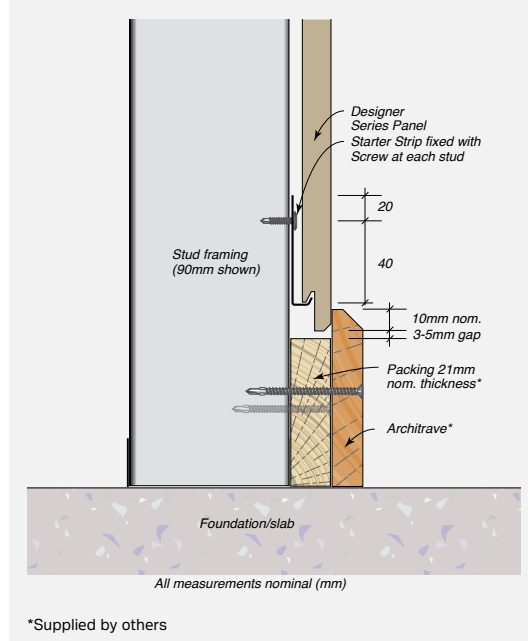

FIGURE 8.02 Base Detail - With Skirting



*Supplied by others

Head Details

FIGURE 8.03 Head Detail - With Coloured Angle

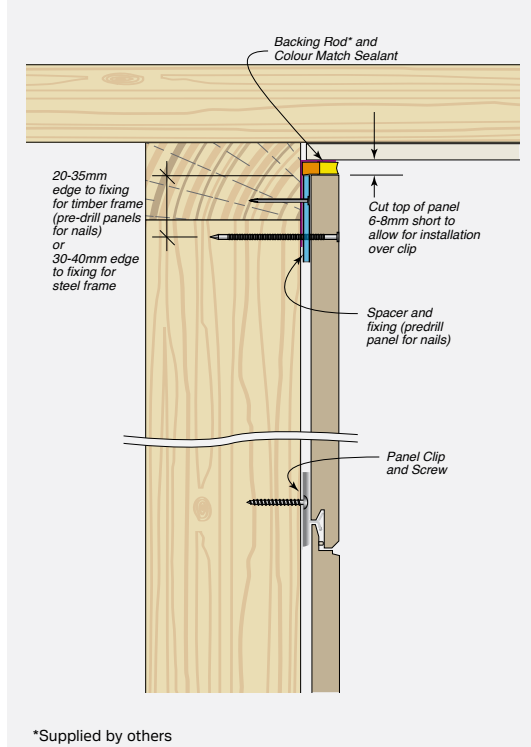
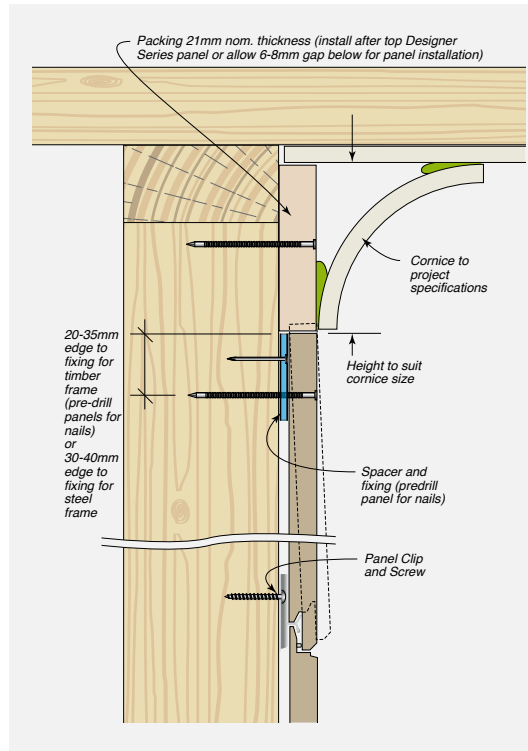

FIGURE 8.04 Head Detail - With Cornice



CONSTRUCTION DRAWINGS AND DETAILS



Note: Drawings are interchangeable for timber or steel substrates with the exception of the fasteners.

Corner Details

Additional studs may be required at corners to allow for fixing Panel Clips, other components and to support joint backing rod.

FIGURE 8.05 Preformed External Corner – Plan View

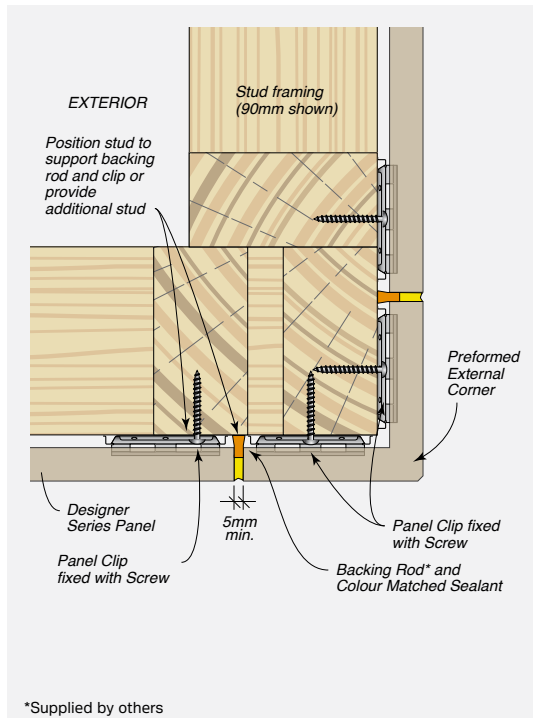

FIGURE 8.06 Internal Corner with Backing Rod and Colour Matched Sealant – Plan View

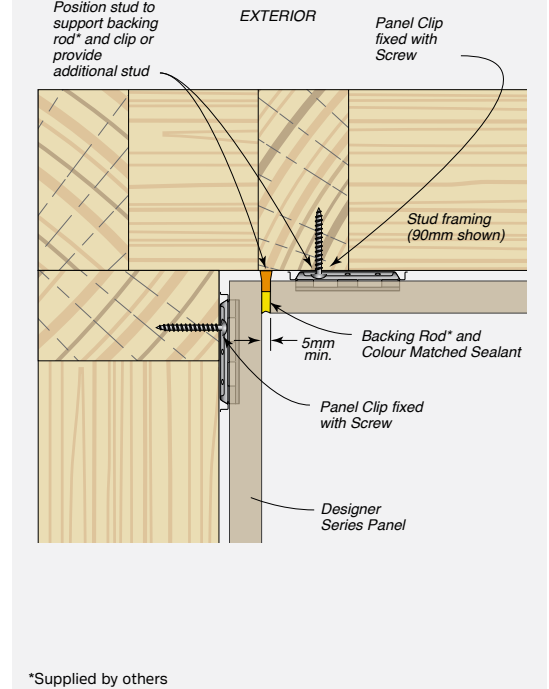
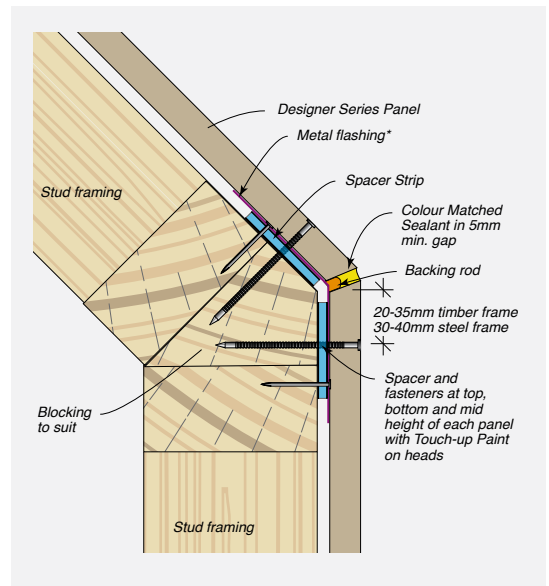
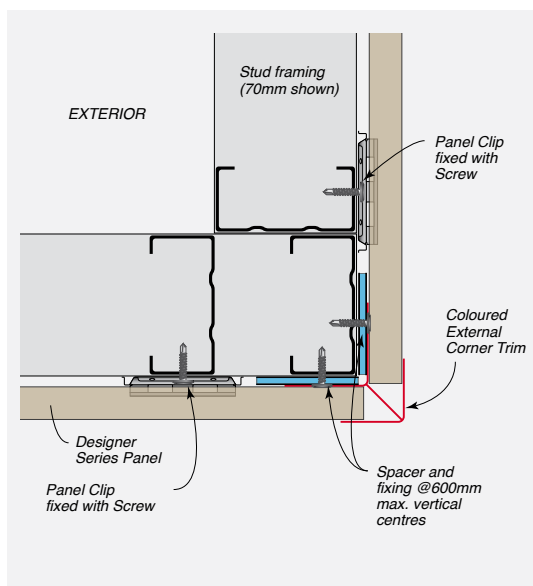

FIGURE 8.08 Obtuse Angle Corner with Metal Flashing and Colour Matched Sealant – Plan View





CONSTRUCTION DRAWINGS AND DETAILS

Note: Drawings are interchangeable for timber or steel substrates with the exception of the fasteners.

Junction Details

FIGURE 8.09 Typical Junction with Plasterboard Wall – Plan View

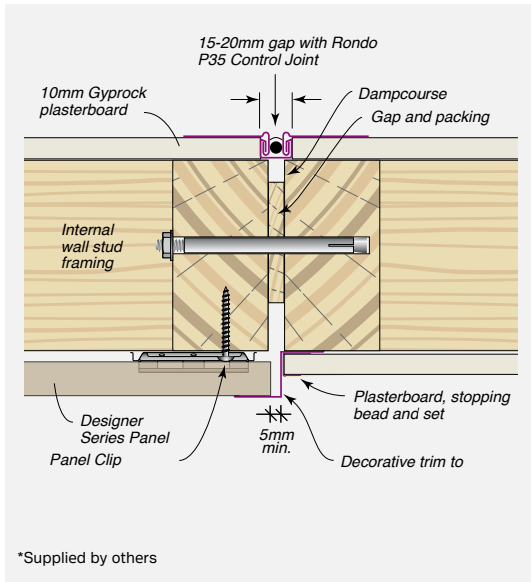

FIGURE 8.10 Typical Junction with Masonry Wall – Plan View

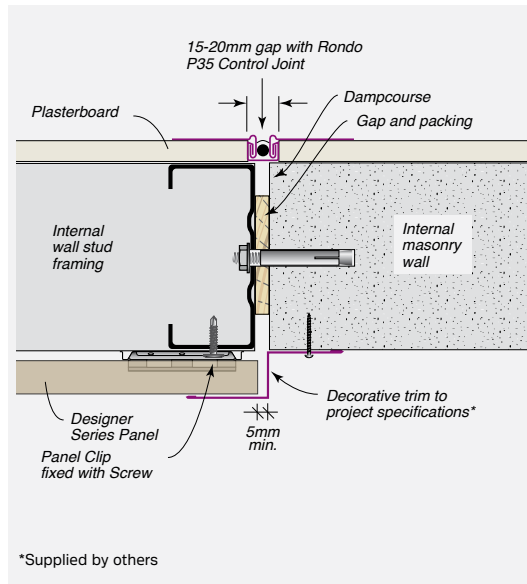
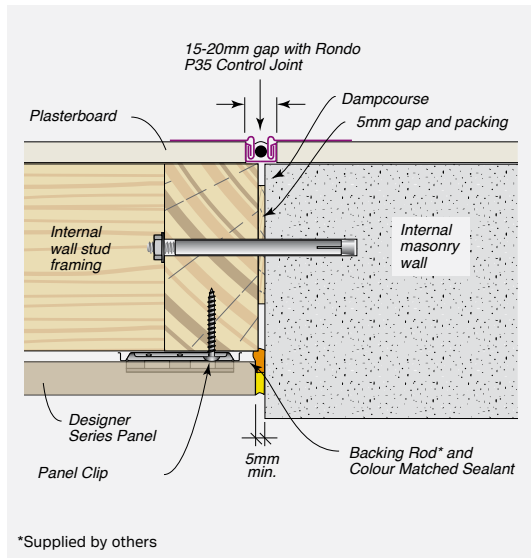

FIGURE 8.11 Typical Junction with Deep Masonry Wall – Plan View



CONSTRUCTION DRAWINGS AND DETAILS



Note: Drawings are interchangeable for timber or steel substrates with the exception of the fasteners.

Vertical Installation

Base Details

FIGURE 8.12 Base Detail - With Sealant

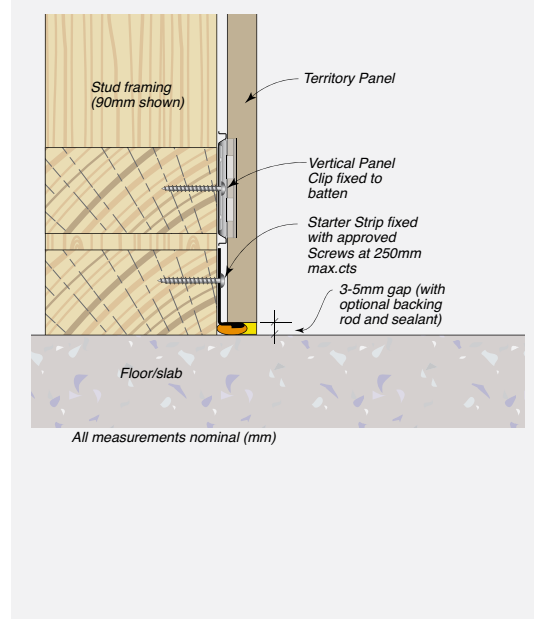
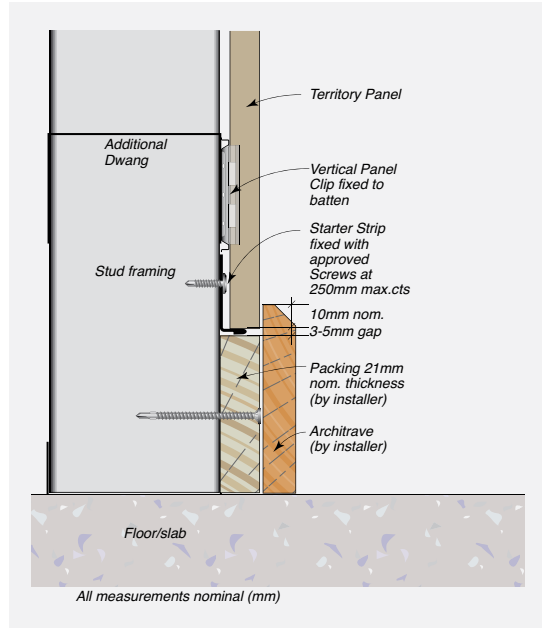

FIGURE 8.13 Base Detail - With Skirting



Head Details

FIGURE 8.14 Head Detail - With Sealant

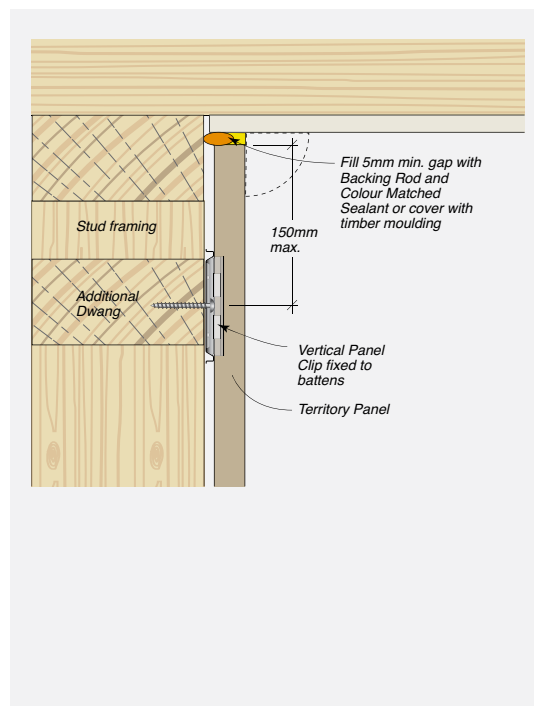
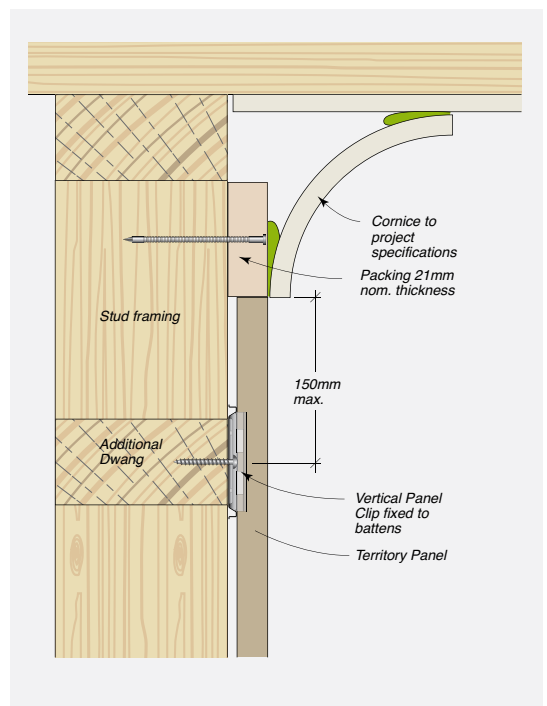

FIGURE 8.15 Head Detail - With Cornice





CONSTRUCTION DRAWINGS AND DETAILS

Note: Drawings are interchangeable for timber or steel substrates with the exception of the fasteners.

Corner Details

Additional studs may be required at corners to allow for fixing of, Designer Series Panel Clips and other components.

FIGURE 8.16 External Corner Detail – With Preformed Corner – Plan View

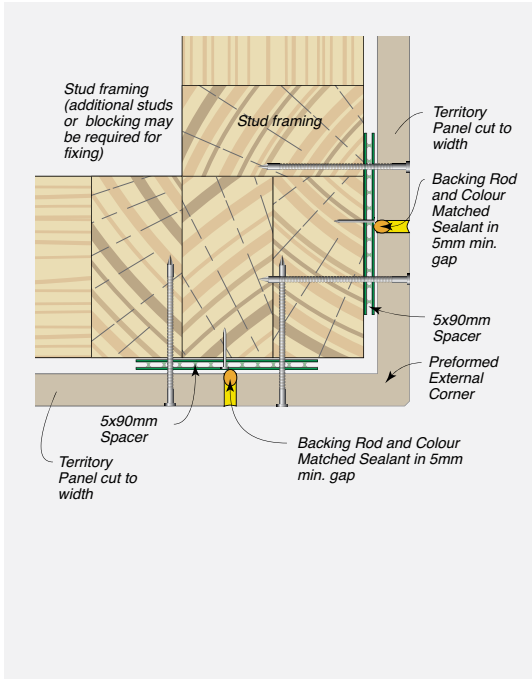

FIGURE 8.17 Internal Corner Detail – With Backing Strip and Colour Matched Sealant – Plan View

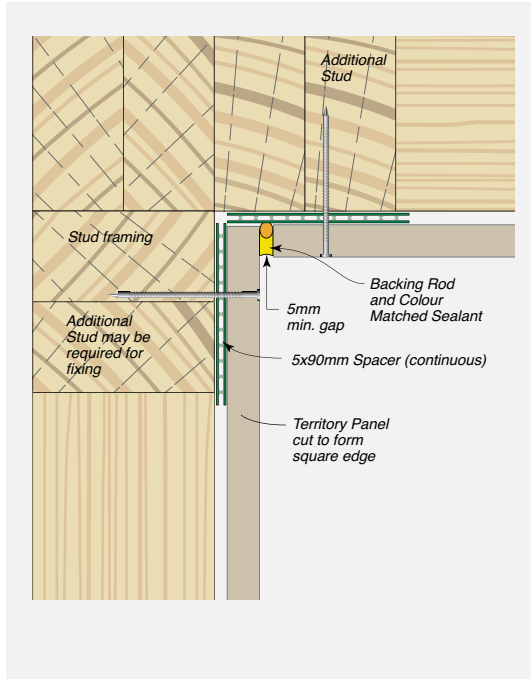

FIGURE 8.18 External Corner Detail – With Coloured External Corner Trim – Plan View

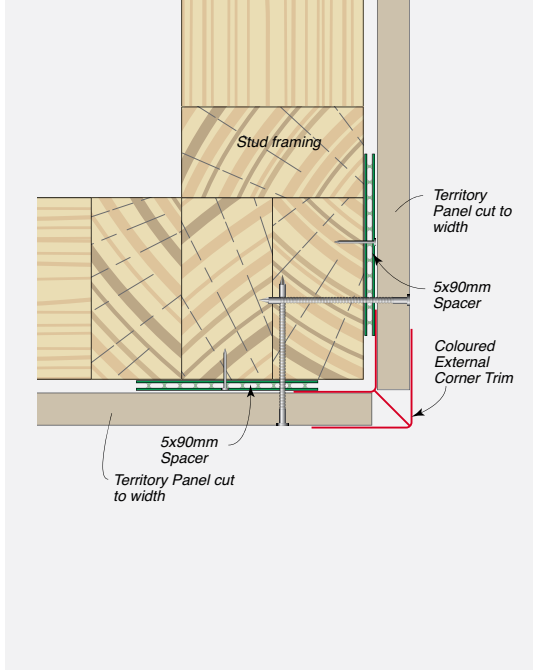
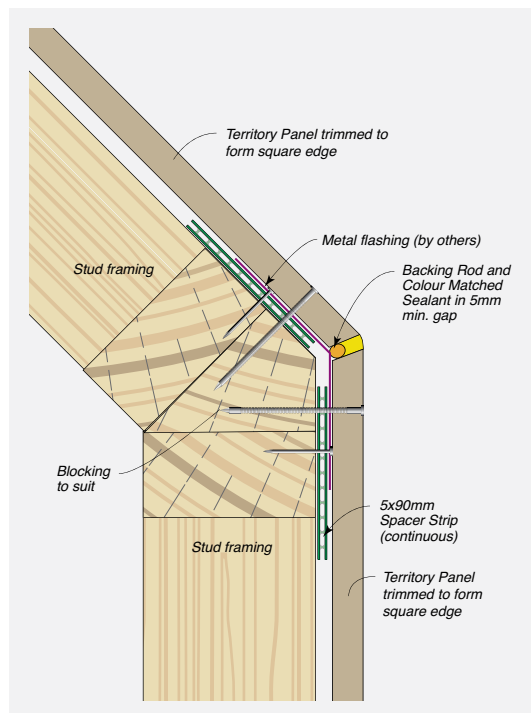

FIGURE 8.19 Obtuse Angle Corner Detail – With Metal Flashing and Colour Matched Sealant – Plan View



CONSTRUCTION DRAWINGS AND DETAILS



Note: Drawings are interchangeable for timber or steel substrates with the exception of the fasteners.

Junction Details

FIGURE 8.20 Junction with In-line Masonry Wall – Plan View

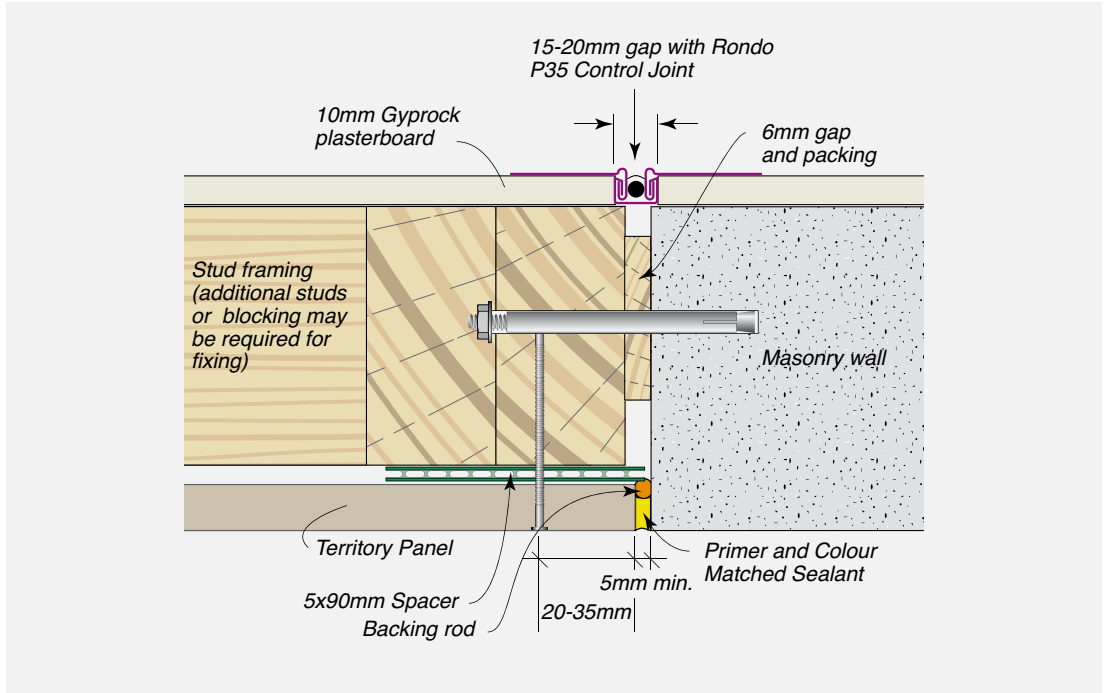
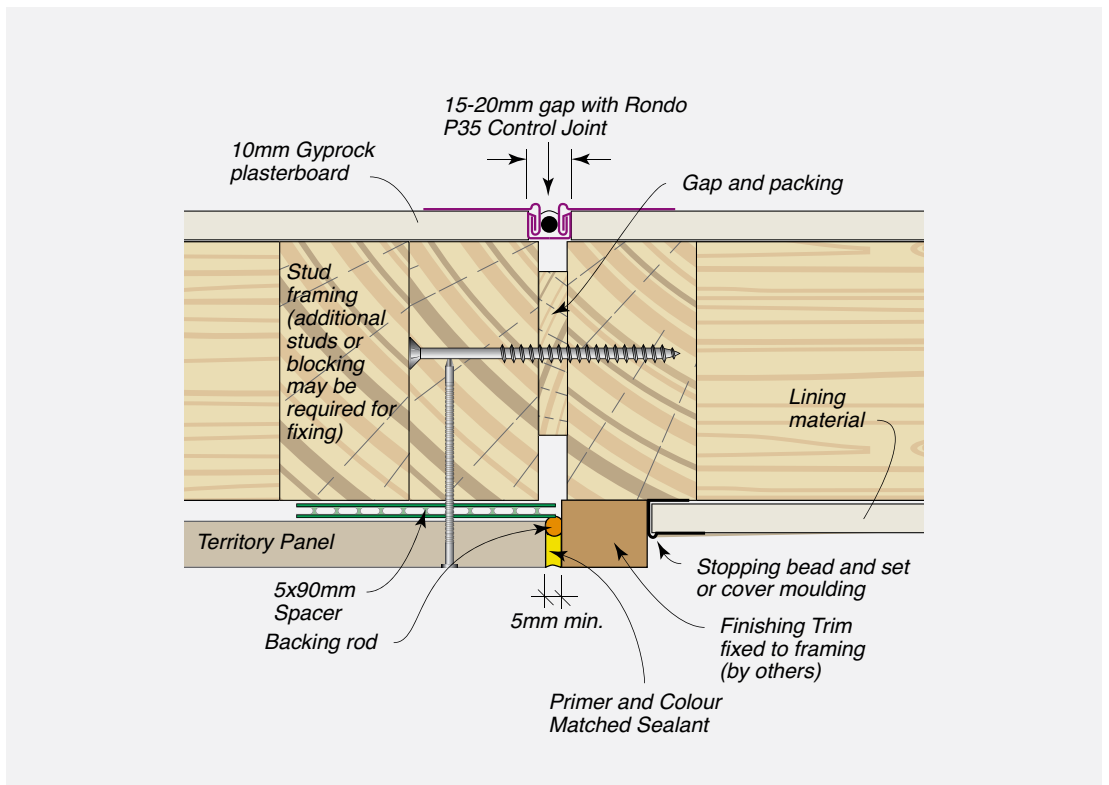

FIGURE 8.21 Typical Detail Junction with Fibre Cement Cladding System – Plan View





**SAFETY, HANDLING
+ GENERAL CARE**

SAFETY, HANDLING + GENERAL CARE



Health, Safety and Personal Protection Equipment (PPE)

Panels contain silicas that are harmful if inhaled. Protective clothing and breathing equipment should be worn when cutting products.

When cutting, drilling or grinding Territory panels using power tools, always ensure the work area is properly ventilated. An approved dust mask AS/NZS 1715 and AS/NZS 1716 and safety glass (AS/NZS 1337)

must be worn. Cemintel recommends using a dust extraction system. Hearing protection should also be worn.

Safety Data Sheet information is available at cemintel.com.au



Recommended Safe Working Practices

Cutting Outdoors

1. Position cutting station so wind will blow dust away from the user or others in the working area.
2. Use a dust reducing plunge saw equipped with a dust extraction system.

Sanding/Drilling/Other Machining

When sanding, drilling or machining, you should always wear a P1 or P2 dust mask and warn others in the immediate area.

Important Reminders

1. **NEVER** use a power saw indoors.
2. **NEVER** use a saw blade that is not purpose-made for cutting fibre cement products.
3. **NEVER** dry sweep.
4. **ALWAYS** follow tool manufacturers' safety recommendations.
5. **ALWAYS** maintain tools in a clean condition.

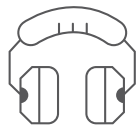

Handling & General Care

Storage

All Territory panels must be stacked flat, clear of the ground and supported at 300mm maximum centres on a level platform. Panels must be kept dry, preferably stored inside the building. Panels must be dry prior to fixing, hence if it is necessary to store outside, the product must be protected from the weather.

Handling

Territory panels and corners are pre-finished products and must be treated with care during handling so as to avoid damage to edges, ends and pre-finished surface. Panels should be carried horizontally on edge by two people.

As the Territory range is a pre-finished product, consideration should be given to the activity of other tradespeople, in particular, a brick cleaner. It is highly recommended that installation of Territory should always be held off until the process of brick cleaning has been completed so as to avoid damage.

Cutting

Panels should be cut from the back using a power saw. Cemintel NZ recommends using the FESTO TS 55EBQ Plunge Cut Saw with guide rail and appropriate blade.

All exposed cut edges such as the window heads and roof junctions must be coated with approved paint. Refer to 'Components' table for appropriate materials.

Mitreing of Panels

It is not recommended to mitre panels as this can cause delamination of the face.

Face Fixing of Panels

At face fixing points, all panels must be supported by a Spacer Strip of 200mm minimum length. Panels must be pre-drilled to accept nails. Use a 2.5mm drill bit and drill from the front. Nail/screw heads should finish flush with the panel surface. All visible nail/screw heads should be neatly covered with primer and colour-matched paint used sparingly. Do NOT use sealant on nail heads.

Penetrations

Penetrations in panels may be cut or drilled prior to installation. Cut from the back or drill from the front. Cut penetrations oversize by 8-10mm all around. Mask, prime and fill gaps with sealant in accordance with recommend methods and products.

Bevelled Edges

The top edge of panels at window sill level may require bevelling. Cemintel NZ recommends using the FESTO DSC-AGP 125 Diamond Blade Cutting and Grinding Tool.



WARRANTY, CLEANING + MAINTENANCE

Warranty

The Cemintel Territory panels have a product warranty of 15 years.

The full Cemintel Territory product warranty is available for download at cemintel.co.nz

Wash Down

When cleaning panels, use no more than 700psi (50kg/cm²) of water pressure at 3 to 3.5m distance from the face. Water pressure should be applied downward to avoid forcing water into tongue and groove joints.

Use neutral detergent with a soft brush when removing dirty spots from a panel. When diluting the neutral detergent, follow the manufacturer's instructions, and use the weakest solution possible.

Graffiti Protection

For walls requiring anti-graffiti protection, Cemintel NZ recommends the application of Watty!® Poly U-400 Anti-Graffiti Clear. Please refer to Watty!® for coating instructions and the warranty conditions of this product.

Recoating

If recoating in an alternative colour is desired, Cemintel NZ recommends the use of 1 coat of Watty!® Aquaprep Primer Sealer Undercoat and 2 coats of Watty!® Solagard®.

Prior to any recoating, panels should be washed down, as per the maintenance instructions, and the coating should be applied as per Watty!® instructions.

Cemintel NZ recommends that only Territory Savanna is suitable for recoating with an alternative colour.

Inspection, Repair and Maintenance

The durability of the Cemintel Territory range can be enhanced by periodic inspection and maintenance. Inspections should include examination of the coatings, flashings and seals. Any cracked or damaged finish or seals which would allow water ingress must be repaired immediately by resealing the affected area, or by removing the panel and replacing sealant. Any damaged flashings, sheets or sealant must be replaced as for new work.

Regularly inspect panel surfaces and follow wash-down procedures when required. Small blemishes can be repaired using touch-up paint or other approved paint.

Ensure ventilation and drainage gaps between panels and flashings are clear of any debris.

It is recommended storing additional panels in case any panels are damaged in the future. Any small chips can be painted over with touch up paint which both hides the underlying panel colour and seals the panel to prevent moisture ingress.

If a whole panel needs to be replaced, the panels which sit above it will need to be removed one by one from the heading, and then reassembled with joints resealed.



Cemintel is a business division of CSR Building Products (NZ) LTD

Our Office

Auckland

14 The Furlong
Takanini
Auckland

0800 999 277

cemintel.co.nz

Disclaimer: Information presented in this document is supplied in good faith and to the best of our knowledge, was accurate at the time of preparation. Products are subject to natural variation as part of the manufacturing process. Product images may vary from actual product in regard to colour and surface finish. The provision of this information should not be construed as a recommendation to use any of our products in violation of any patent rights or in breach of any statute or regulation. Users are advised to make their own determination as to the suitability of this information in relation to their particular purpose or specific circumstances. Since the information contained in this document may be applied under conditions beyond our control, no responsibility can be accepted by Cemintel, or its staff for any loss or damage caused by any person acting or refraining from action as a result of misuse of this information.