

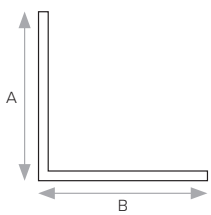

ALUMINIUM EXTRUSIONS

Metalcraft Insulated Panels source aluminium profiles from local suppliers for use in the cool store industry as well as commercial and architectural markets. Our stocked range of profiles include: Angles, Channels, Tees, I Beams and Door sections.

90° EQUAL ANGLES/UNEQUAL ANGLES



A	B	Thickness
25	25	1.6
40	40	1.6
50	25	1.6
50	50	3.0
70	25	1.6
70	40	1.6
70	50	3
120	70	1.6

EXTERNAL ANGLES

40x40mm External Angle

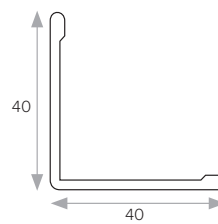

50x50mm External Angle

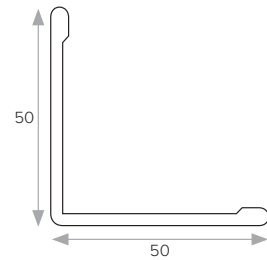

INTERNAL ANGLES

40x40mm Internal Angle

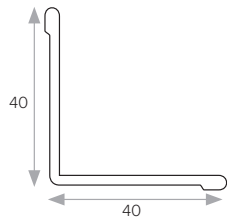

50x50mm Internal Angle

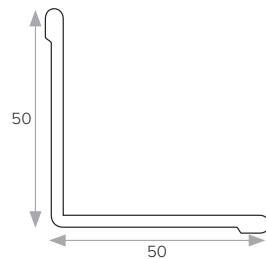

I BEAMS

50mm I Beam

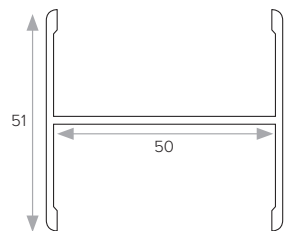

75mm I Beam

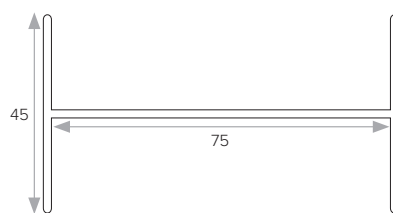

100mm I Beam

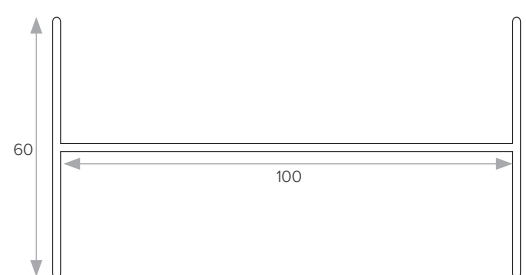

EQUAL CHANNELS

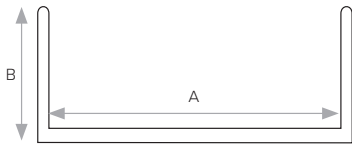

A	B
50	25
75	25
115	25
150	25
165	25

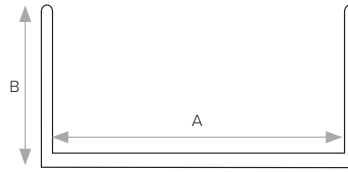

A	B
75	32
88	32
100	32
150	38

UNEQUAL CHANNELS

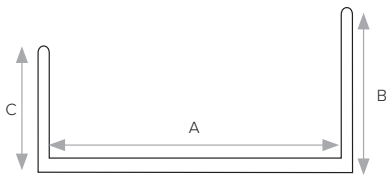

A	B	C
50	45	30
75	45	30
100	45	30

DRI CHANNELS

75mm DRI Channel

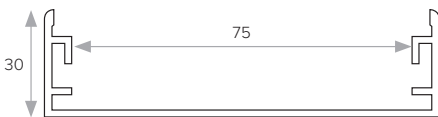

100mm DRI Channel

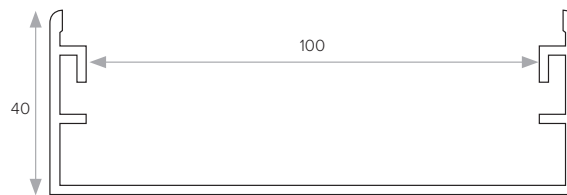

DRI ANGLES

40x40mm External DRI

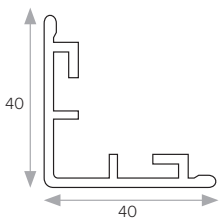

40x40mm Internal DRI

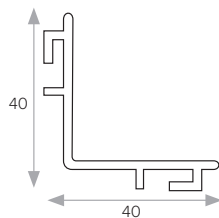

DOOR JAMBS

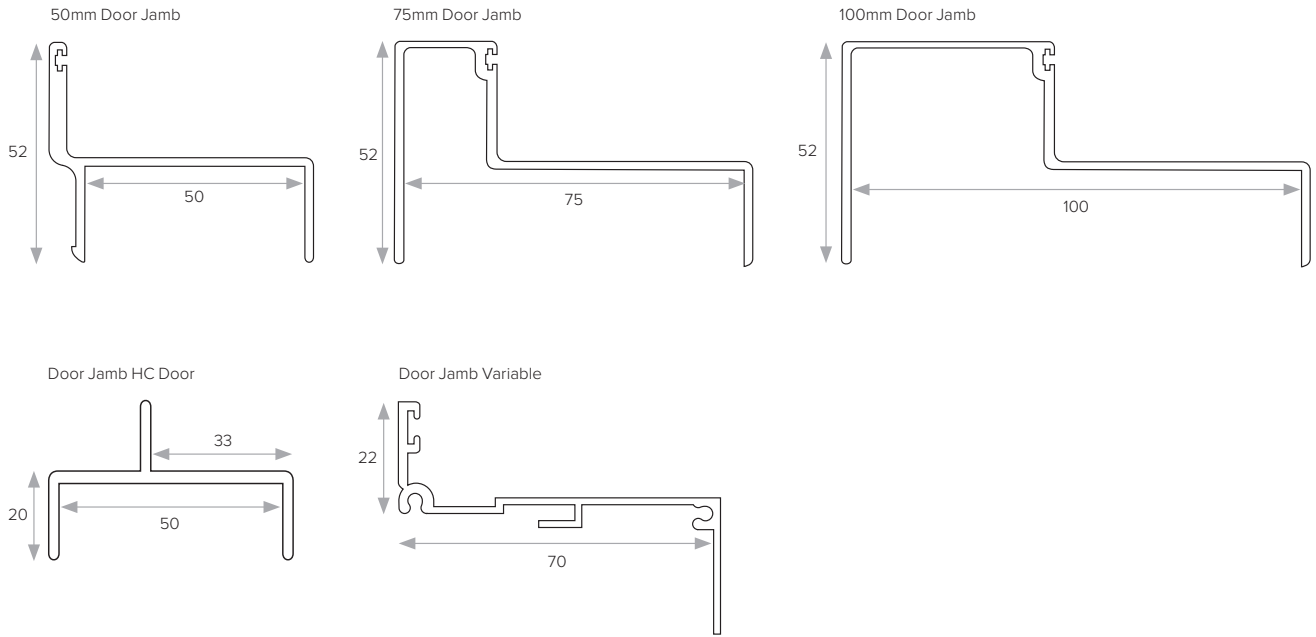

RADIUS

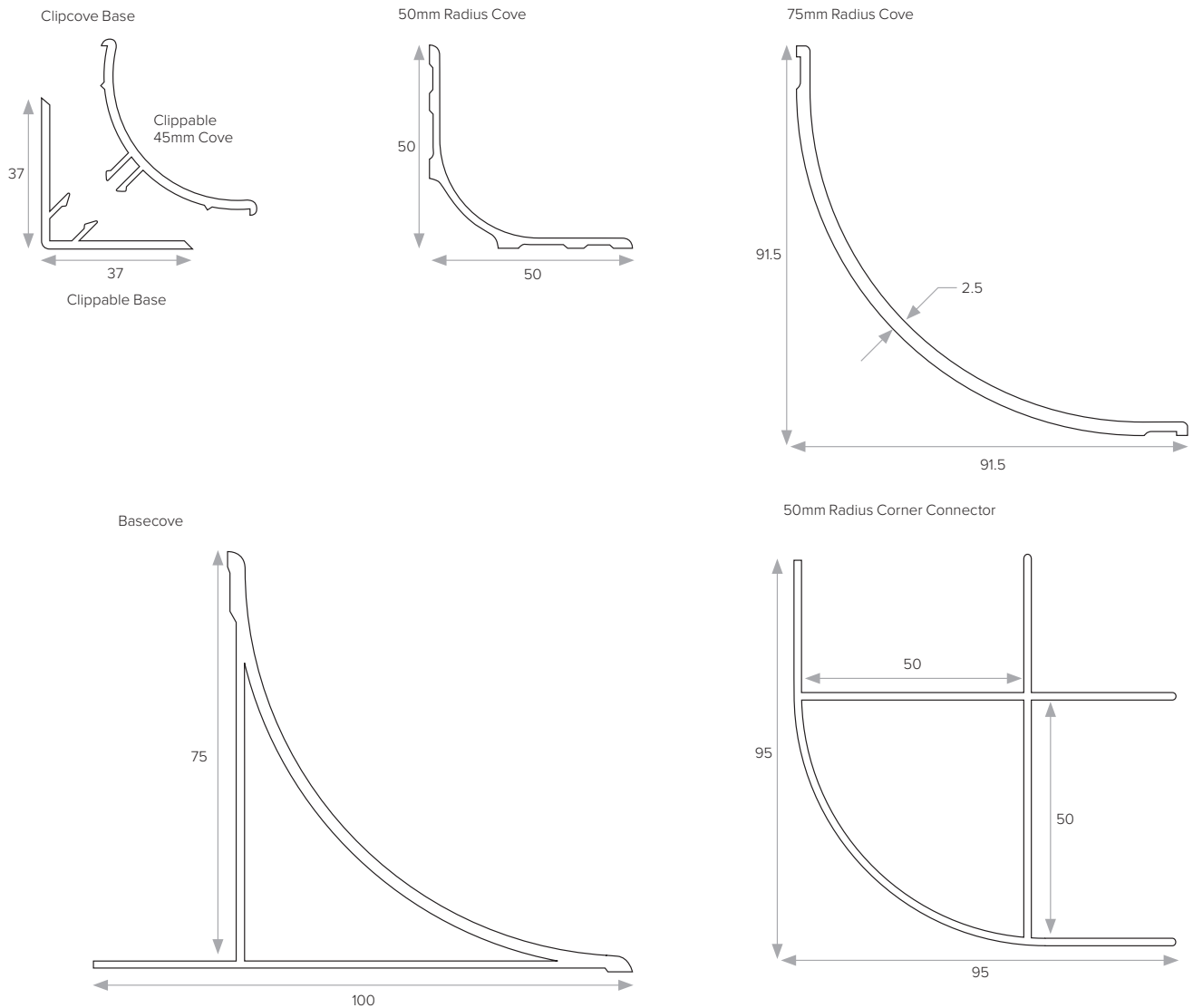

STRIPS & GASKETS

Breakerstrip Blue



Breakerstrip Grey



U Gasket

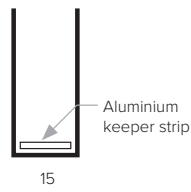

DYNEX RUBBER STRIPS

9101BLK300

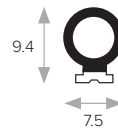

4591 BLK200

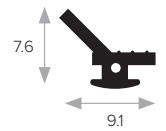

T SECTIONS

38mm T Section

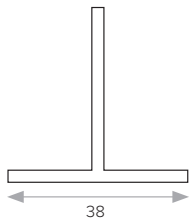

F MOLD

40x60mm F Mold

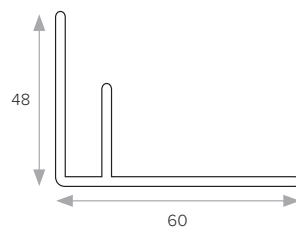

MISCELLANEOUS

50mm Corner Connector

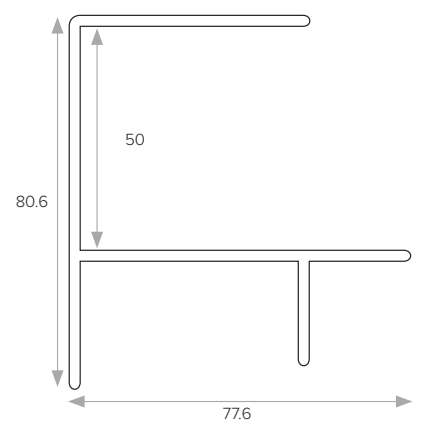

TRACKS

Bottom Track

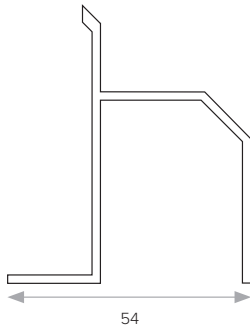

Door Track Small

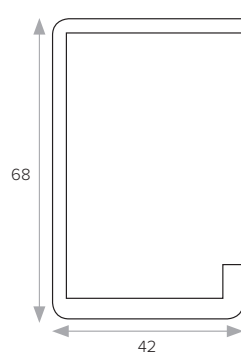

Door Track Large

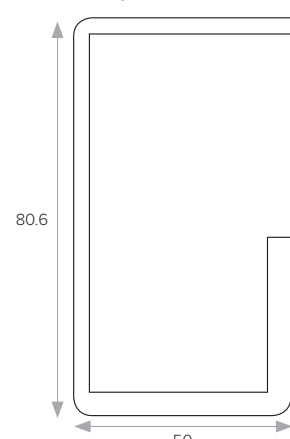

BRANCHES

AUCKLAND

139 Roscommon Road, Wiri, Auckland
T: 09 277 8844
sales@metpanels.co.nz

HAMILTON

9 Earthmover Cres, Burbush, Hamilton
07 849 3807
sales@metpanels.co.nz

DISCLAIMER

As part of Metalcraft Insulated Panels policy of continued improvement, final specifications may vary from those contained in this publication. The company reserves the right at any time and without notice to change the design, materials or features and withdraw products from the market without incurring any liability whatsoever. This publication is issued as a general guide only and should not be treated as a substitute for technical advice. Contact with your nearest Metalcraft branch is recommended to confirm current specifications and availability.



For more information on Metalcraft Roofing visit:
www.metalcraftgroup.co.nz
Metalcraft Roofing is part of United Industries Ltd.
For more information on United Industries visit:
www.unitedindustries.co.nz