



THE
BUILDING AGENCY

InnoClad Weatherboard Cladding System

 **INNOWOOD**

SUSTAINABLE TIMBER ALTERNATIVE

Installation Manual

Vertical V-Joint Ship-lap 25mm Cladding

20mm Cavity

New Zealand



Nº 19111



WC13625
WC20025
WC24025



**BUREAU
VERITAS**



CODEMARK™
CM70078

[v1.6] Aug. 2023

Table of Contents

1. Vertical V-Joint Ship-lap 25mm Cladding System - Introduction	3
1.1 Scope	3
1.2 Warranty	3
1.3 Compliance to NZBC	4
2. - InnoWood Parts	5
2.1 - InnoWood Cladding Boards	5
2.2 - Flashing System & Accessories	5
2.3 - Tools Required	5
3. - Scope & Application	6
4. - Fundamental Considerations	7
4.1 - Coating	7
4.4 - Keeping In Mind	10
5. - Site Storage	11
6. - Sub-Structure Support Options	12
6.1 - Timber Batten - 20mm Minimum Requirements	12
6.2 - HDPE Cavity Packer Batten - 18mm Minimum Requirements	13
6.3 - Typical Sub-structure Set-out for 20mm Cavities	14
7. - Specific Details	15
7.1 - Foundations & Surface Water	15
7.2 - Ground Clearance	15
7.3 - Moisture Management	15
7.4 - Pressure Equalised Ventilation	16
8. - Detailed Construction Drawings	17
9. - Document Control	48
9.1 Installation Manual - Revisions	48
9.2 Compliance Documentation	48

1. Vertical V-Joint Ship-lap 25mm Cladding System - Introduction

INNOWOOD's Ship-lap Cladding System features an interlocking tongue and groove design to achieve concealed fixings while providing a conventional timber appearance with a warm, clean and durable finish. Consistently uniform shadow lines between the boards become architectural features when the boards are installed either horizontally or vertically.

INNOWOOD V Joint Ship-lap boards overlap one another, V Joint Ship-lap Cladding system comes in 25 mm thick boards with 'V' shaped tongue and groove shadow line rebated joints. This overlap conceals the fixing and locks the boards together to give a clean finish with effective board coverages of:

- 105mm - WC13625
- 165mm - WC20025
- 205mm - WC24025

These profiles can be mixed and matched to achieve varying board widths, creating a unique architectural feature.

INNOWOOD'S material characteristics open a wide variety of possibilities. It can be used as External Cladding, Internal Lining, Shading, Street Furniture and Screening.

INNOWOOD operates within an environment of continuous improvement and innovation.

All INNOWOOD products may be upgraded to achieve a particular fire performance rating on request.

1.1 Scope

- Wind zones up to 2.5 kPa ULS
- All corrosion zones of New Zealand
- Under 10m in total building height
- Further than 1 meter from a relevant boundary

1.2 Warranty

- 10 Year Materials

1.3 Compliance to NZBC

See Section 9: Document Control for Compliance Information download Packs

If designed, installed and maintained in accordance with all The Building Agency requirements, InnoWood InnoClad 25mm Ship-Lap Cladding System will comply with or contribute to compliance with the following performance claims:

-B1: Structure

B1.3.1, B1.3.2, B1.3.3(a, f, h, j), B1.3.4

InnoWood Cladding will meet or contribute to the requirements of this clause arising from self weight, wind-load and impact.

-B2: Durability

B2.3.1(b), B2.3.2 (b)

When applied in the manner as set-out by this manual and typical details, and within the requirements of section 1.1, by a licensed building practitioner InnoWood is expected to provide at least a 15 year serviceable life.

-E2: External Moisture

E2.3.2, E2.3.5, E2.3.7

InnoWood is a verified alternative method has been tested to NZS4284, and E2/VM1 by an IANZ accredited laboratory. Generic performance up to a ULS of $\pm 2.5\text{kPa}$ is recorded by typical detailing in this installation manual

-C1-6: Protection from Fire

InnoWood is manufactured with self extinguishing additives imbued into its makeup, these additives can be increased at a sacrifice to the overall strength of the InnoWood.

Therefore exterior grade InnoWood has balanced fire and structural capabilities, while interior InnoWood is able to be less rigid, therefore can provide higher fire performance.

- InnoWood has been tested to ISO5660.1: PHRR: 83.7kW/m² & AHRR: 59.7MJ/m²
- InnoWood has been tested to EN13501-1: B:s2,d0
- InnoWood has been tested to AS1530.3: Group 1S for interior use only (By Indent Order Only)
- InnoWood is not a suitable material for use on buildings >10m in total height, or closer than 1m to a relevant boundary unless expressly assessed by a certified fire designer.

-F2: Hazardous Building Materials:

F2.3.1

InnoWood does not contain or emit harmful materials.

2. - InnoWood Parts

2.1 - InnoWood Cladding Boards



- **WC13625** -
105mm Cover



- **WC20025** -
165mm Cover



- **WC24025** -
205mm Cover

2.2 - Flashing System & Accessories

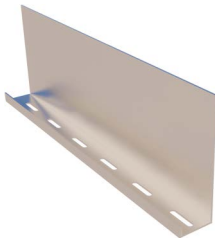

- **J-Mould Punched** -
5.8Lm/Length

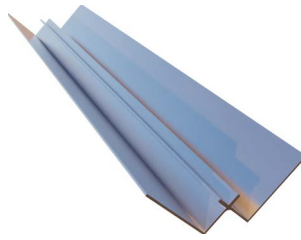

- **Int. Corner** -
3.2Lm/Length

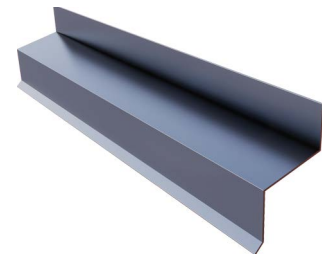

- **Inter-storey** -
3Lm/Length
Suit 20mm cavity Battens

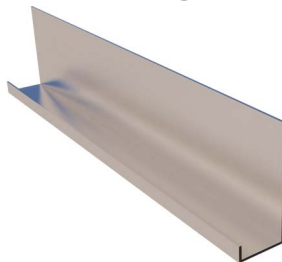

- **J-Mould**
-5.8Lm/Length

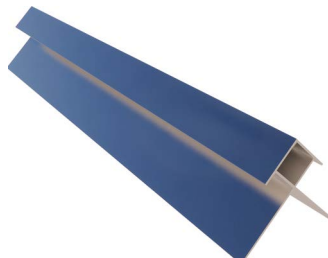

- **Ext. Corner** -
3.2Lm/Length

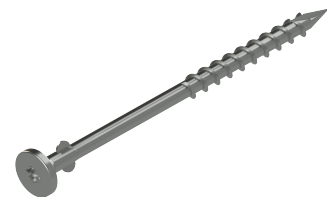

- **Innowood Timber Screw**
- 10gx85mm SS(A2)
- 10gx50mm SS(A2)

2.3 - Tools Required



Typical Timber Working Tools

3. - Scope & Application

InnoWood cladding installed as per this specification provides a durable and natural cladding with a timber appearance for use in residential and commercial buildings. The product can be installed over a timber batten, forming a drained and pressure equalised cavity cladding system. Ensure that you follow the design, preparation and installation guidelines of this manual. It is your responsibility to check if you have the latest version of the manual.

Updates can be found on the website www.thebuildingagency.co.nz

This manual and the contained Typical Detailed Drawing set covers the use of InnoWood when installed on any of the support systems, set forth in Section 6. - Sub-Structure Support Options as a cladding solution within the following scope:

- Wind zones up to ± 2.5 kPa ULS
- All corrosion zones of New Zealand*
- Under 10m in total building height
- Further than 1 meter from a relevant boundary

- For projects outside of this scope, please contact The Building Agency -

It is the designer's responsibility to review the project requirements of the cladding system. It is always understood that this verification is to include but is not limited to:

- Fire, Bracing, Acoustic, Thermal, Structural
- Verification that InnoWood selection will comply with these and all other requirements

**Where projects are located in geothermal micro-climates; consultation with The Building Agency is advised.*

4. - Fundamental Considerations

4.1 - Coating

To prolong the effects of fading, InnoWood is supplied factory pre-coated. However, no matter what kind of coating is used, after years of sunlight and different levels of ultraviolet exposure, the products will still gradually fade to different levels.

If the surface of the InnoWood colour begins to show signs of severe discolouration or if there is a desire to change the colour tone then follow the instructions specified in the InnoWood Re-coating Procedure Guideline, to maintain or change the colour of the product.

The degree of discolouration of the pre-coated product and the durability of the coating are difficult to measure so cannot be specifically guaranteed, depending on the environment in which the product is installed performance of the colour can vary.

This can be illustrated by the installation of the same material with same coating and the same surface treatment but after a period of time, products exposed to direct sunlight appear to fade faster than products exposed to less sunlight. This is not a product or coating issue but is a natural phenomenon found in all natural materials where the colour is affected to different degrees dependant on the level of direct sunlight.

For regions with low UV intensity, the durability of the coating to weathering can be maintained for approximately 5-7 years. In regions with high UV intensity or extreme weather, the durability of coating to weathering can be maintained for approximately 2-4 years. This guide also applies to decking applications but bear in mind that the amount of foot traffic and wear combined with the direct angle of incidence of sun on the flat surface will reduce the coating life expectancy guidance by at least another year.

This colour fade does not in any way effect the overall performance of any part of the cladding system, unlike alternative natural timber products which weaken over time without their coatings and specific considerations.

Further information on fading and coating can be found here :
<https://innowood.com/natural-weathering-and-recoating/>

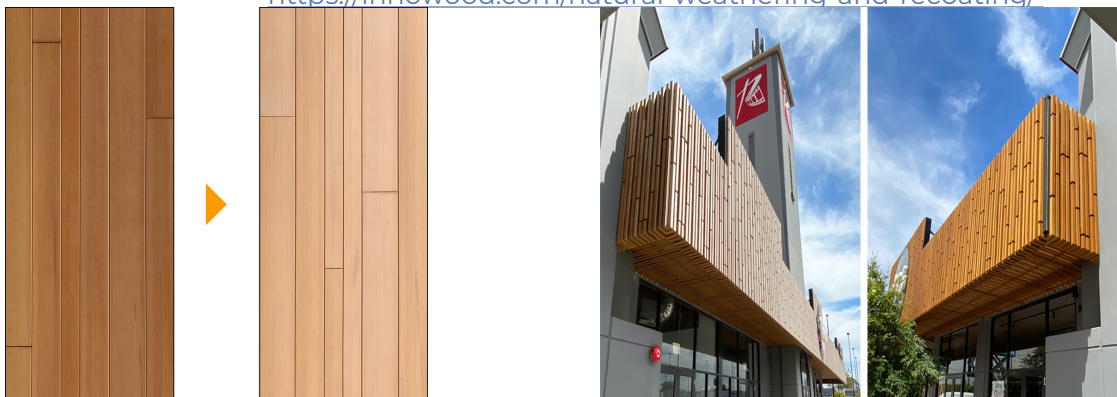

Before > After
Fading

Before > After
Re-coating

4.2 - Thermal Movements & Reflective Surfaces

Any wood based products will expand and contract with changes in temperature. The amount of expansion varies according to the amount of change in temperature. Although thermal movements are reversible, these movements due to temperature change may vary by up to 2mm per meter.

InnoWood boards that have been exposed to direct sun for several hours, prior to installation will have expanded more than boards left in the shade. Its important to maintain an average consistent temperature for all boards as they are being installed. Avoid installing in full sun if ambient temperature is above 30°C.

Ensure the boards are kept out of the sun until installed to limit the boards expansion prior to installation. InnoWood products can tolerate a temperature range from -20°C to +65°C. If the product is to be used in an environment outside of this temperature range -please consult The Building Agency.

Reflective surfaces such as metal or asphalt roofing can add to the heat load of the cladding due to UV rays reflecting off the surface, which may adversely affect the InnoWood product under normal installation conditions.

Therefore additional supports must be used to counter this as follows:

Any cladding which is above a metal roof requires the battens to be installed at maximum 225mm centres for any area of cladding which is within 1.2m radius of the metal roof (in any direction). (Fig. 4.2a)

Fig. 4.2a

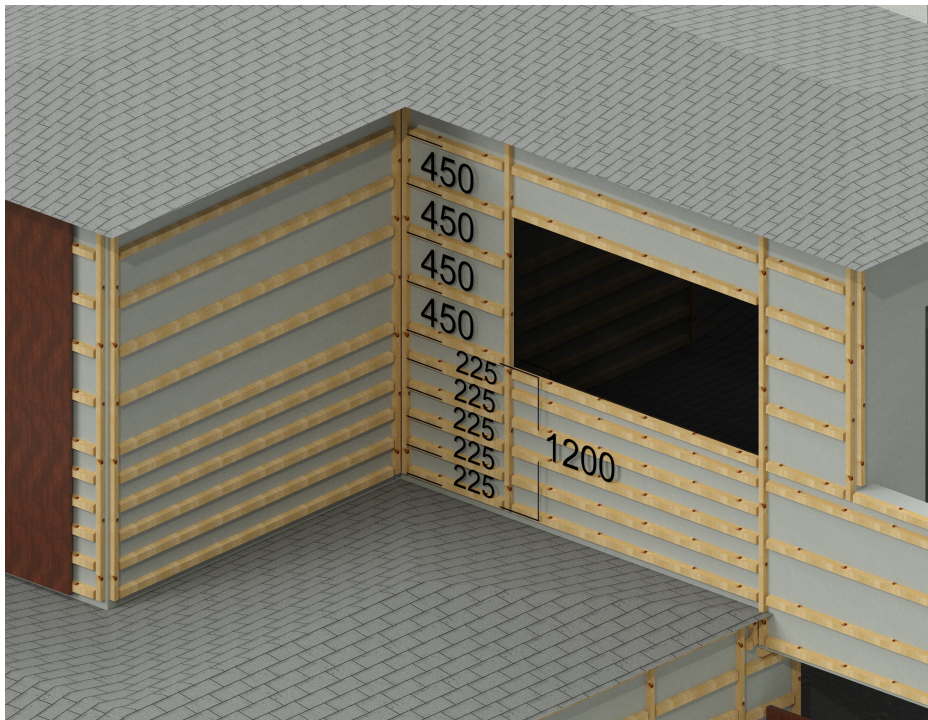

4.3 - Batches and Colours

Please note that the product is subject to natural variation in finish as part of the manufacturing process. The purchaser or builder/installer is responsible for inspecting the colour, finish and size of the product prior to installation as well as identifying whether the product has any defects or manufacturing faults.

Ensure the product meets surface appearance and product specification requirements. Subject to the terms of our warranty, InnoWood is not liable for claims made after the installation of the product that relate to surface appearance and product specification.

InnoWood product is made predominantly from a timber bi-product. The colour will vary up to 20% +/- according to the timber used in its manufacture. It is the responsibility of the specifier or other party to ensure that the information in this manual is appropriate for the intended application and further design detailing may have to be made for specific applications that fall outside the scope of the manual.

Information contained on this document is the copyright of The Building Agency. Use or copying of this document in whole or in part without the written permission of The Building Agency is not permitted.

It is important during installation to take boards from various boxes to create a natural variation in tone.

Correctly Installing Colour & Texture Variation Between Batches



Correctly Mixed batches and boxes, achieving a natural variance & good finish



Incorrectly Mixed batches and boxes, leaving blocks of colour

4.4 - Keeping In Mind

- Face Fixings are required at every board end, applied to the tail of each board through the v-groove of the board it interleaves with.
- Where face fixing is required, clearance holes must be pre drilled. The clearance hole drilled must be slightly greater than the outside screw thread diameter.
- Only proprietary Building Agency screws should be used to fix the InnoWood cladding.
- When Building Agency Screws do not provide a comprehensive solution please contact The Building Agency for confirmation of suitable substitution.
- When substituting fastenings pre-drilling of all fastening locations is required.
- Screws must be a minimum 15mm but maximum 25mm away from board edges (unless noted otherwise).
- InnoWood products must not be used for any structural purpose.
- Where visible a cut in InnoWood must be sealed with a layer of protective coating such as a water based deck sealer before installation.
- When exposed to direct sunlight, surface temperature may be significantly hotter than ambient temperature.
- Never span cladding across seismic or expansion joints in structure. If necessary terminate the cladding on either side of any expansion joint to prevent damage to the cladding and/or structure.

5. - Site Storage

InnoWood boards should not be stored in the open or wrapped or covered with plastic sheet. They should be stored under cover and protected from the elements (including direct sunlight and rain) until ready to install. Remove any plastic wrap including shrink wrap and store on a dry and flat surface supported at maximum spans of 450mm on centre. Acceptable storage method examples are pictured below.

- When removing InnoWood boards from the pack, do not slide boards against each other, lift the boards and set them down carefully.
- InnoWood boards should be carried on their edge for better support and take care to avoid scratches, nicks and other damage to the boards.
- InnoWood boards are a pre-finished product, do not dump or drop when loading or unloading, always handle with care.
- If you are intending to use off-cuts, the same storage and handling applies.

**Never store InnoWood uncovered & exposed to the elements or in direct sunlight.*

***To ensure long-term performance, all installation needs to be performed by either LBP or installers that are trained and certified by The Building Agency Training Academy.*

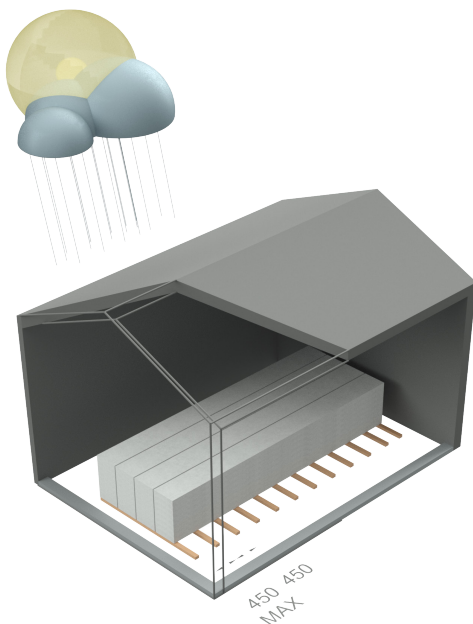

Correctly Stored Indoors:

- Under cover, in a protected, shaded & flat location.
- Unwrapped from any packing plastics
- Equally supported at Maximum 450mm centres.

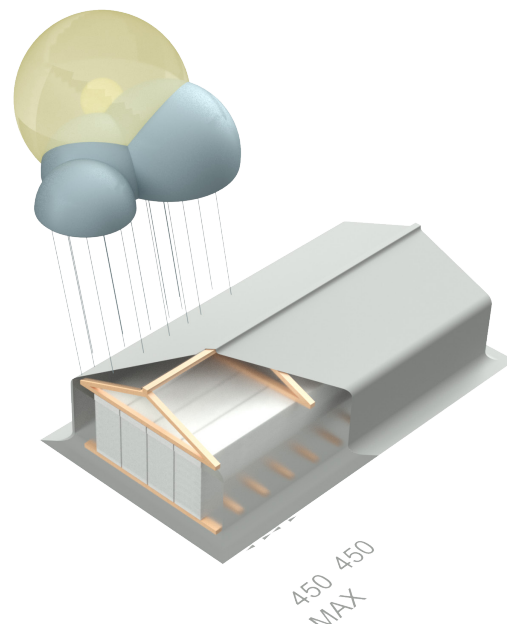

Correctly Stored Outdoors:

- Protected with a water-proof cover, in a protected, shaded & flat location.
- Unwrapped from any packing plastics
- Truss framed support to prevent cover from contacting the packets
- Equally supported at Maximum 450mm centres.

6. - Sub-Structure Support Options

InnoWood cladding must be installed onto structural battens or non-structural cavity packers, depending on fixing selection and pattern. The system must achieve a drained, de-pressurised ventilated cavity between the back of the cladding boards and main structure. This spacing and minimum cavity requirements assists in preventing the boards from over heating and potentially warping.

- Minimum Free Airflow Cavity Size: 35mm (17mm InnoWood + 18mm Batten)
- Minimum Soffit Cavity Size: 15mm

**Ventilation cavity sizes also account for 17mm ventilation created by the InnoWood profiles included in this manual.*

6.1 - Timber Batten - 20mm Minimum Requirements

SCOPE:

- Up to and including Extra High Wind Zone
- Timber Framed Main Structure to NZS3604 or suitable design by suitably qualified structural engineer.
- Noggs/Dwangs must be provided at maximum 450mm centres (Fig.6.3b) to ensure structural fixing is achieved for the InnoWood, where thermal loading is present this must be reduced to 225mm (See Section: 4.2 - Thermal Movements & Reflective Surfaces)
- Steel Framed Main Structure to all NASH standards applicable
- Concrete Structures compliant to NZS3101 & all other standards applicable
- Maximum 10m high buildings
- Minimum 1 meter away from relevant boundary
- All corrosion zones*

20mm Timber Battens must adhere to the following minimum specifications:

- All elements of external framing must be treated to a minimum H3.1 minimum treatment as per NZS3640.
- Battens must be compliant to NZS3602
- Minimum section for vertically installed InnoWood cladding is 40x20 and 15° cambered top edge, installed to fall away from building membrane
- Recommended section for vertically installed InnoWood cladding is 70x20 and 15° cambered top edge, installed to fall away from building membrane (fig. 6.3a)
- Use of a flexible underlay or Rigid Wall Underlay compliant to E2/AS1 Table 23 is required.
- Fixings of timber battens into the structure should adhere to BRANZ BUILD RIGHT - 154
- Fixings of battens must adhere to E2/AS2 Tables 20, 21, and/or BRANZ BU519 for material compatibility and regional durability selections.
- Fixings of InnoWood into timber with the proprietary stainless steel timber screw and a minimum 35mm penetration into the main timber structure

**Where projects are located in geothermal micro-climates; consultation with The Building Agency is advised.*

6.2 - HDPE Cavity Packer Batten - 18mm Minimum Requirements

SCOPE:

** HDPE Cavity Packer Supplier Technical documentation or testing supersedes the InnoWood recommendations below: it is the Designer's duty to ensure that correct performance is achieved by both systems.*

- Up to and including Extra High Wind Zone,
- Timber Framed Main Structure to NZS3604 or suitable design by suitably qualified structural engineer.
- Noggs/Dwangs must be provided at maximum 450mm centres to ensure structural fixing is achieved for the InnoWood, where thermal loading is present this must be reduced to 225mm (See Section: 4.2 - Thermal Movements & Reflective Surfaces)
- Maximum 10m high buildings
- Minimum 1 meter away from relevant boundary
- All corrosion zones*

18mm HDPE Cavity Packer Battens must adhere to the following minimum specifications:

- Be installed & fixed to the manufacturer's guidelines, and must be constrained by the suppliers scope of application.
- Must be installed in such a way as to allow drainage and ventilation of the cavity.
- Use of a flexible underlay or Rigid Wall Underlay compliant to E2/AS1 Table 23 is required.
- Fixings of battens to structure must adhere to E2/AS2 Tables 20, 21, and/or BRANZ BU519 for material compatibility and regional durability selections.
- Fixings of InnoWood into timber with the proprietary stainless steel timber screw and a minimum 35mm penetration into the main timber structure

**Where projects are located in geothermal micro-climates; consultation with The Building Agency is advised.*

6.3 - Typical Sub-structure Set-out for 20mm Cavities

Recommended Cambered Battens H3.2 20x45mm with a 15° fall directed away from building membrane (Fig. 6.3a) applied to structure where maximum stud centres are 600mm and nogg/dwang centres do not exceed 450mm (Fig. 6.3b) In certain locations thermal loading to the cladding requires additional structural consideration, please see Section 4.2 - Thermal Movements & Reflective Surfaces for requirements.

Fig.6.3a

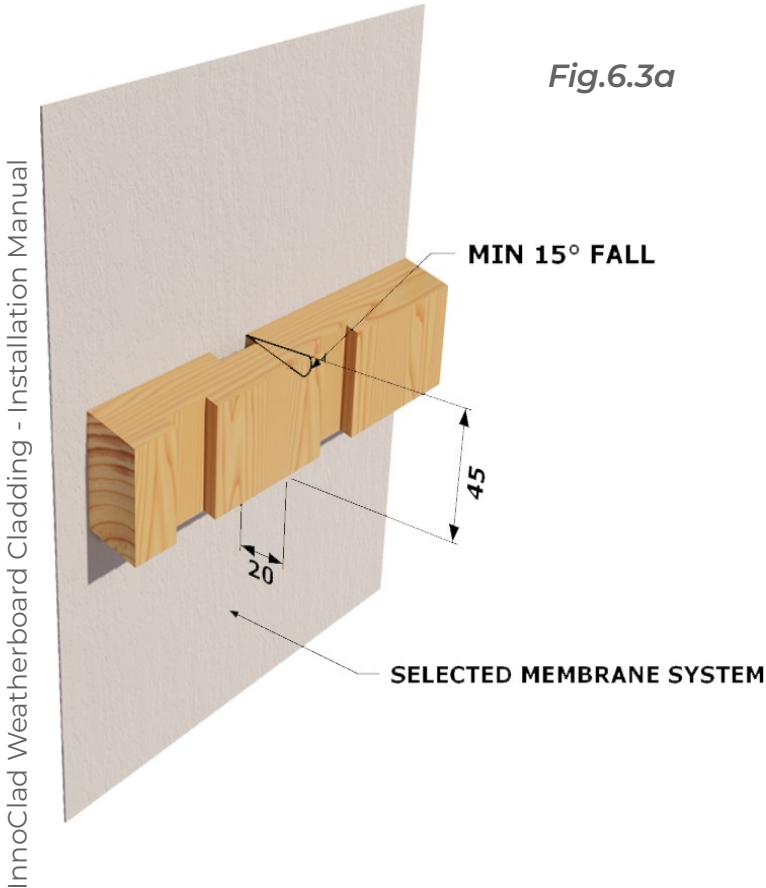
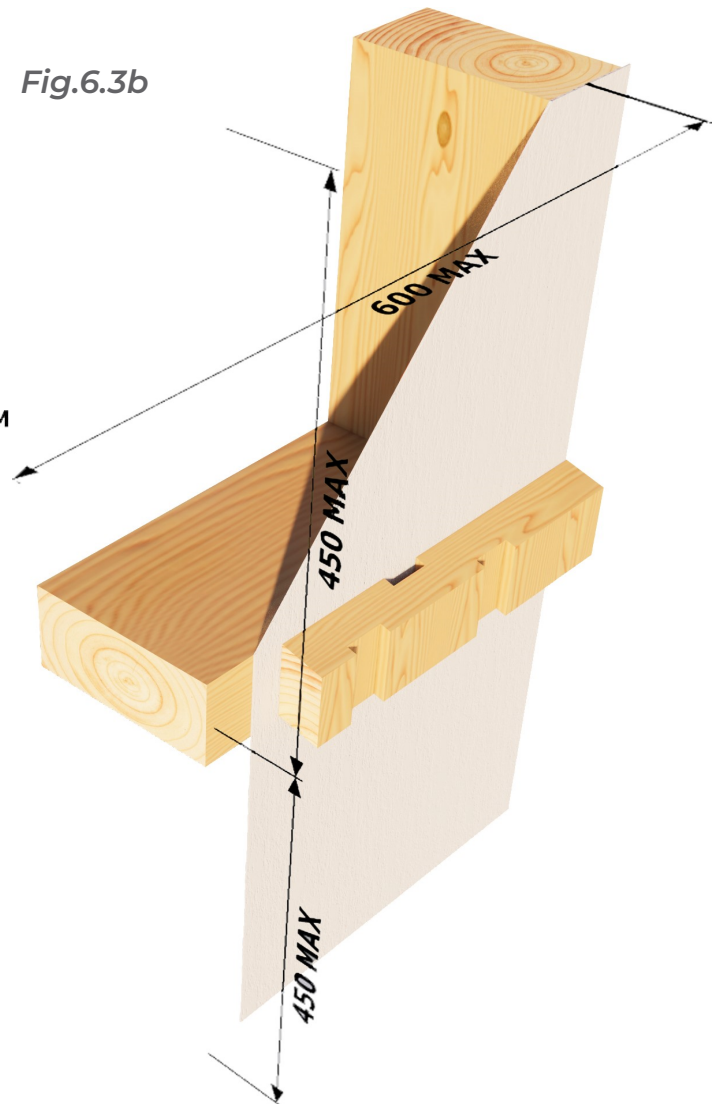

Fig.6.3b



7. - Specific Details

7.1 - Foundations & Surface Water

The site in which the building is situated must comply with the NZBC Acceptable Solution E1/AS1 'Surface Water'.

Foundation design must comply with the requirements of NZS3604 'Timber-framed Buildings' or be as per specific engineering design.

The grade of adjacent finished ground must slope away from the building to avoid any possibility of water accumulation in accordance with the NZBC requirements.

7.2 - Ground Clearance

The clearance between the bottom edge of cladding and paved/unpaved ground must comply with section 9.1.3 of E2/AS1. The finished floor level must also comply with these requirements. These clearances must be maintained throughout the life of the building.

InnoWood must overhang the bottom plate on a concrete slab by a minimum of 50mm as required by NZS3604 & NZBC:E2/AS1.

InnoWood must have a minimum clearance of 100mm from paved ground, and 175mm from unpaved ground. On roofs and decks, the minimum clearance must be 50mm. Do not install external cladding in such a way that at any point it may come into and remain in contact with water or ground.

7.3 - Moisture Management

It is the responsibility of the specifier to identify moisture related risks associated with any particular building design. Wall construction design must effectively manage moisture, Exterior environments of the building, particularly in buildings that have a higher risk of wind driven rain penetration or that are artificially heated or cooled.

Walls must include those provisions as required by the NZBC Acceptable Solution E2/AS1 'External Moisture'. In addition all wall openings, penetrations, junctions, connections, windowsills, heads and jambs must incorporate appropriate flashings for waterproofing. The other materials, components and installation methods used to manage moisture in external walls, must comply with the requirements of relevant standards and the NZBC.

7.4 - Pressure Equalised Ventilation

InnoWood Cladding requires airflow through the cavity from bottom to top, which is achieved with protected openings at the top and bottom of the installation. Preventing the closure of the cladding prevents trapping stale air and moisture.

This de-pressurisation allows fresh, dry air to flow continuously, ensuring a dry and drained cavity. Additionally this schematic prevents diaphragm pressurisation of the cladding under wind-load, improving its ability to shed water and resist the forces of suction more uniformly.

Key dimensions at the top of any cladding to allow for are:

5mm to face of cladding, 15mm from the top of the cladding and >18mm coverage to protect the cavity from maintenance.

**Specific locations have specific requirements, please ensure use of correct details during set-out.*

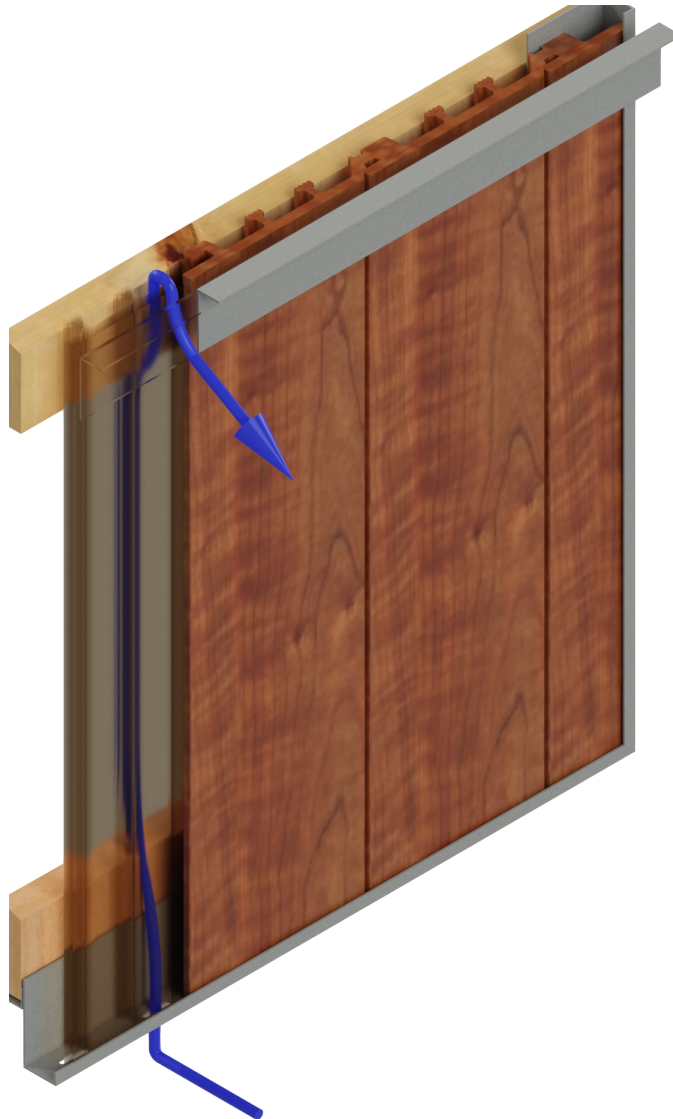

8. - Detailed Construction Drawings

WC13625

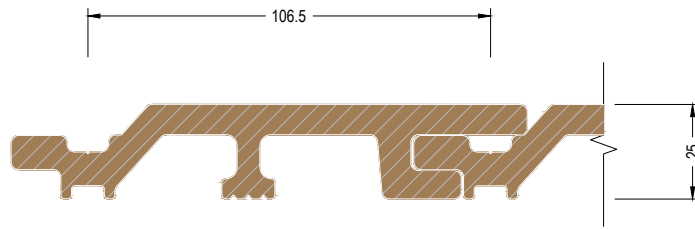

WC20025

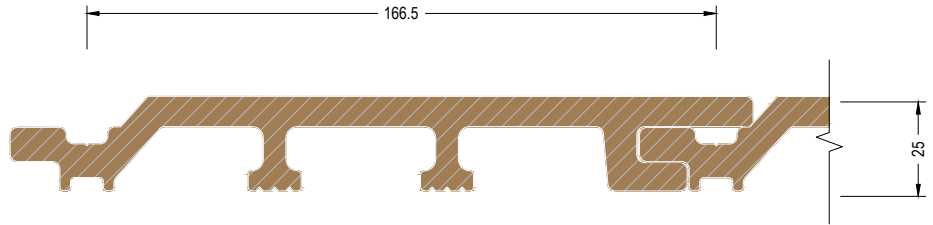

WC24025

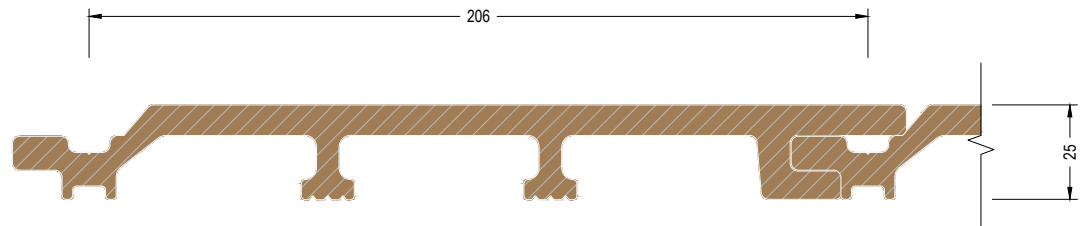

**CLADDING
SCHEDULE**

Detail Number
IC-V20-A01
Version
[v1.6]



MATERIALS • SYSTEMS • SOLUTIONS

H3.2 45x20mm Horizontal Timber Cavity Battens

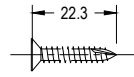
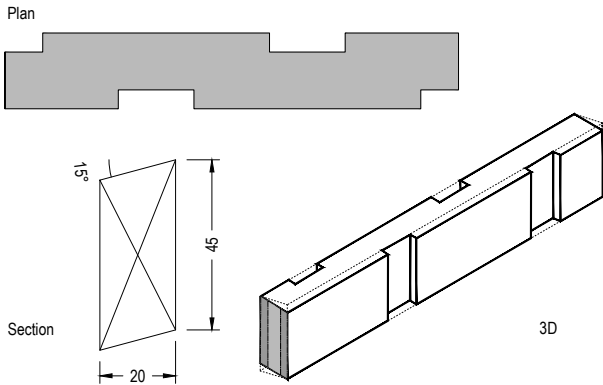

SS304 8gx20mm CSK ST Screw #2 Sq.Dr

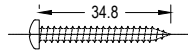

SS304 8gx35mm PH ST Screw #2 Sq.Dr

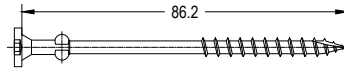

SS304 10g x85 WingNek Ti38 - T20.Dr

25 INN-REG Regular J mould

25 INN-PUN Drained J mould

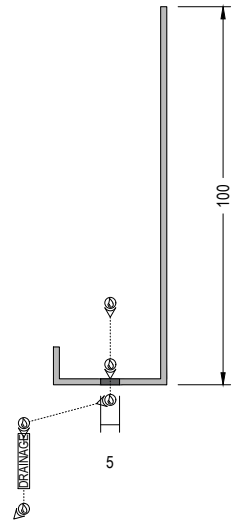
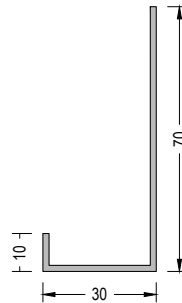

H3.2 45x20mm Vertical Timber Cavity Battens

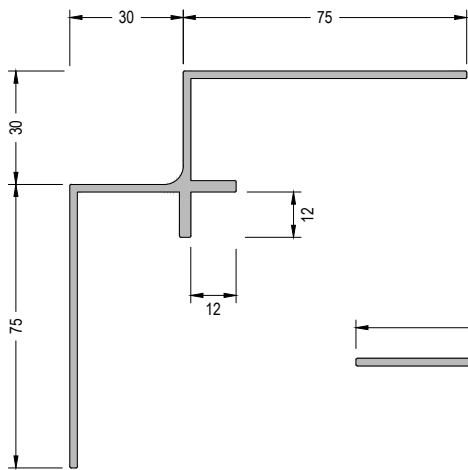
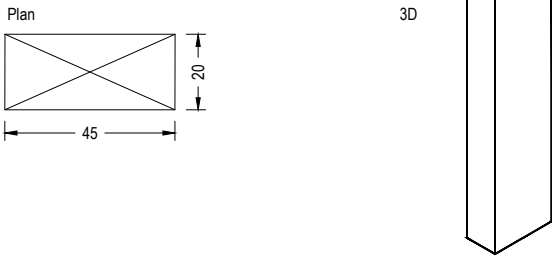

25 INN-INT Internal Corner

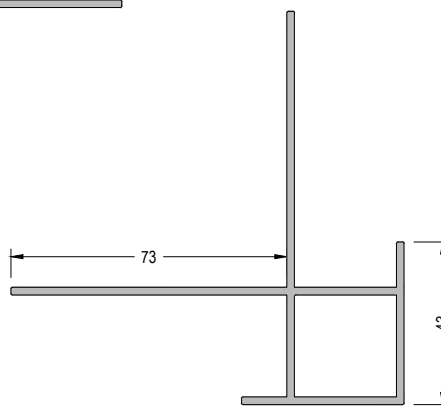

25 INN-EXT External Corner

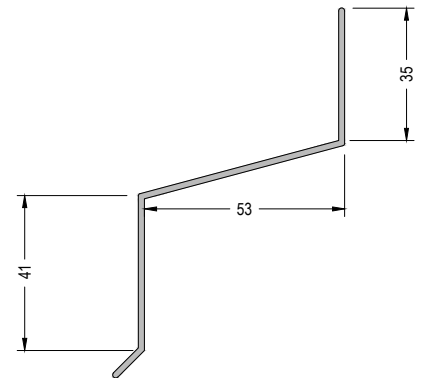

25 INN-INT Interstory Flashing

**ACCESSORY
SCHEDULE**

Detail Number _____
IC-V20-A02
Version _____
[v1.6]



MATERIALS • SYSTEMS • SOLUTIONS

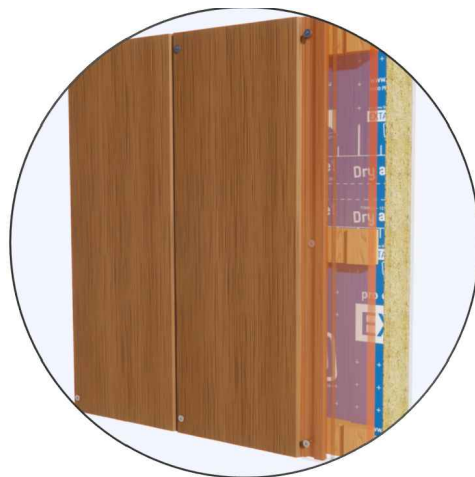
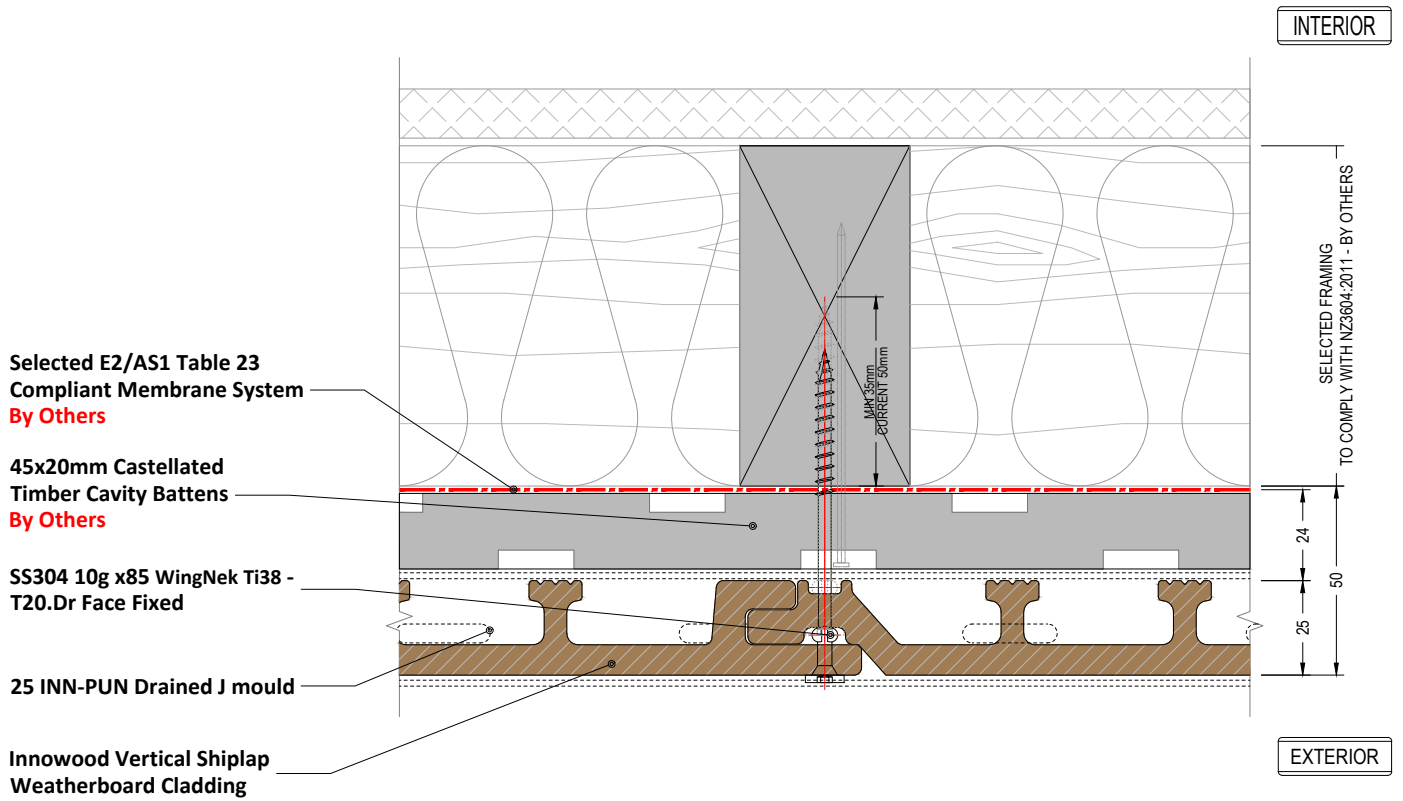

**VERTICAL
JOINT**

Detail Number
IC-V20-001

Version
[v1.6]



MATERIALS • SYSTEMS • SOLUTIONS

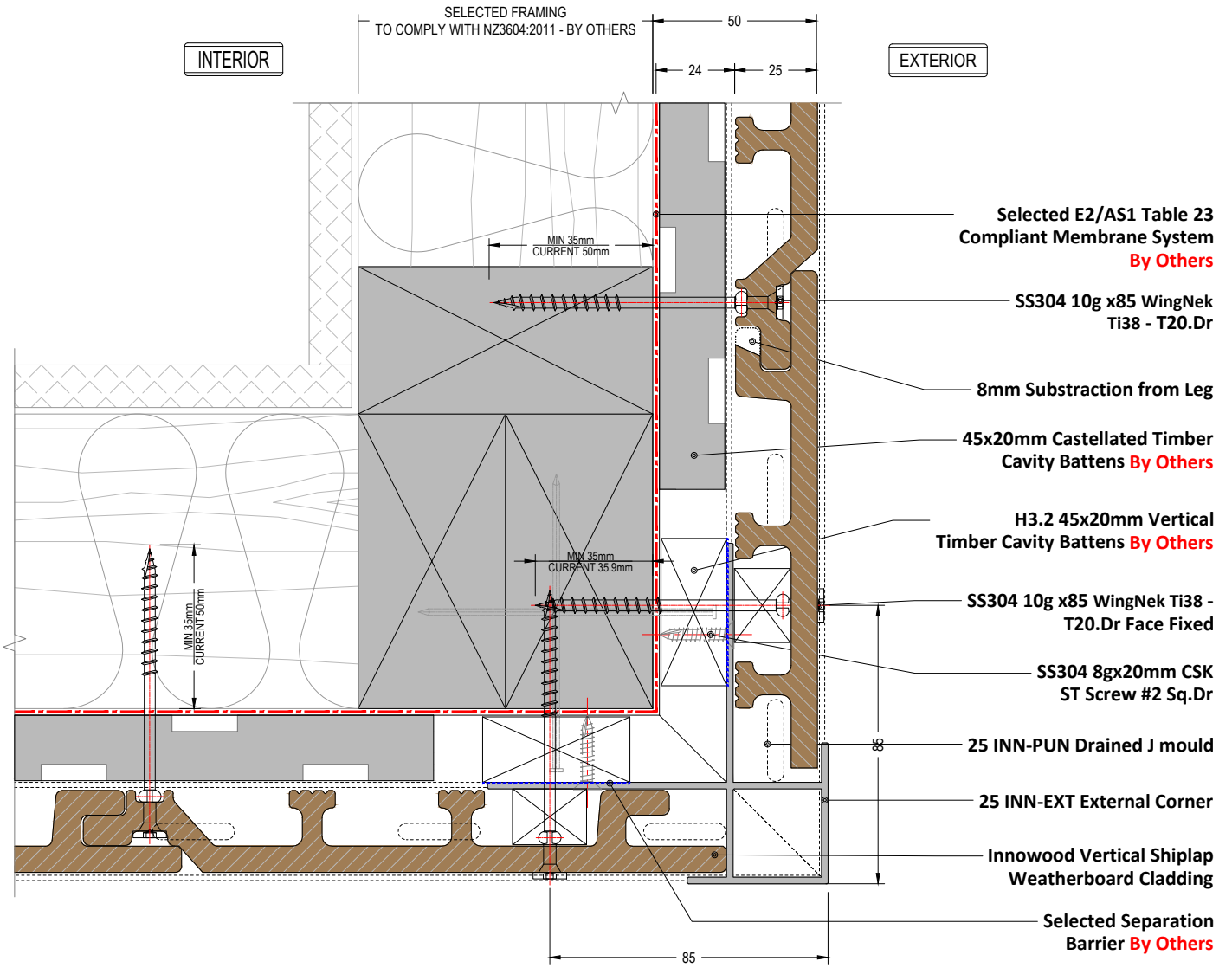

NOTE
Selected Separation Barrier on Timber Batten is only needed on sites with Exposure Zone D

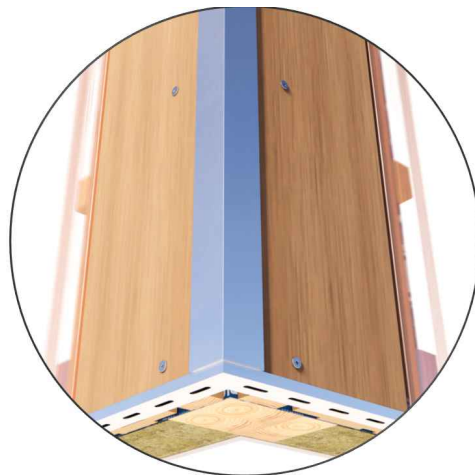

**EXTERNAL
CORNER**

Detail Number
IC-V20-002

Version
[v1.6]



MATERIALS • SYSTEMS • SOLUTIONS

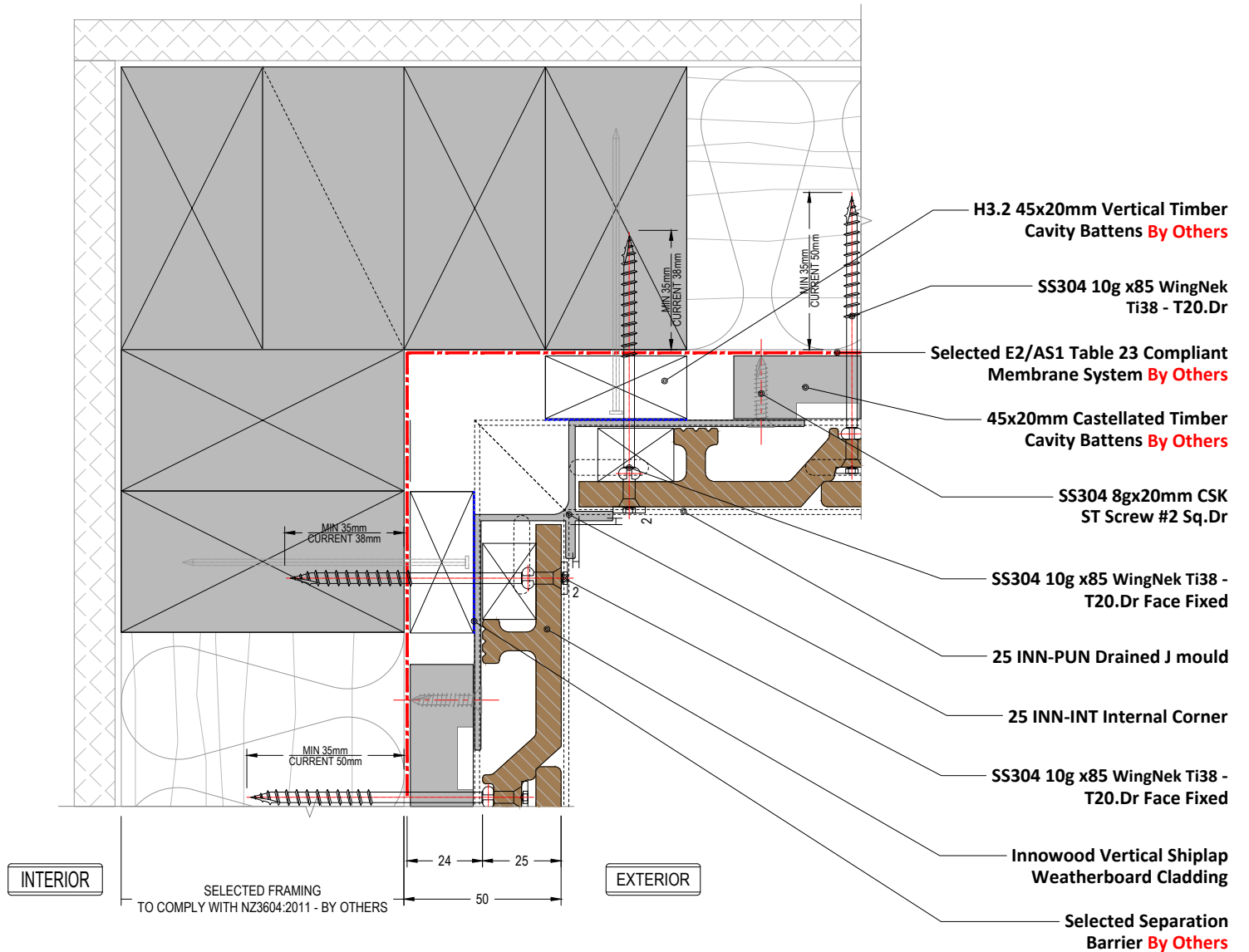

NOTE
Selected Separation Barrier on Timber Batten is only needed on sites with Exposure Zone D



**INTERNAL
CORNER**

Detail Number _____
IC-V20-003

Version _____
[v1.6]



MATERIALS • SYSTEMS • SOLUTIONS

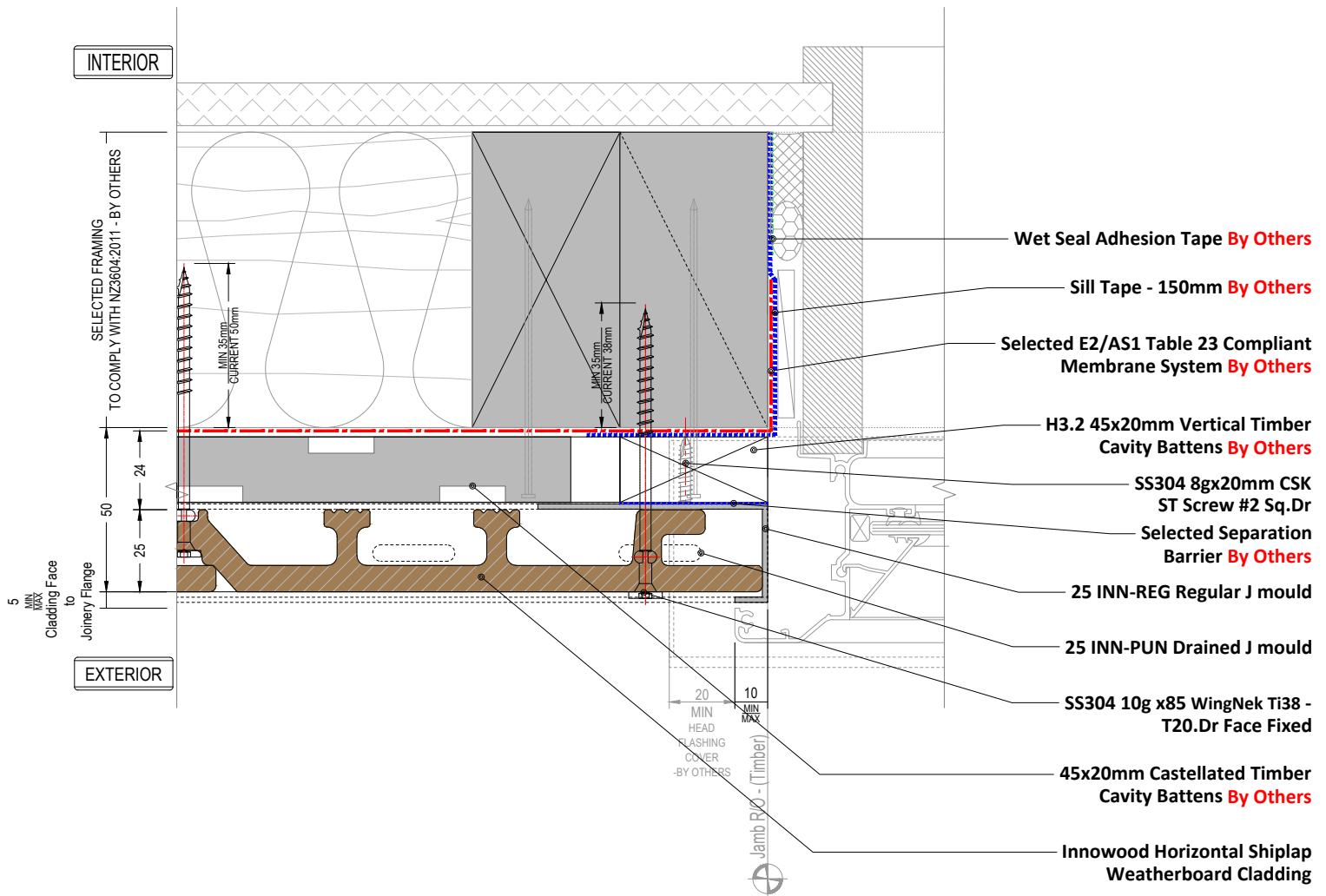

NOTE
Careful consideration to window placement must be made in relation to cladding face to achieve minimal gap.
Seal gaps of 5mm or greater W/ Suitable & Approved Sealant
Selected Separation Barrier on Timber Battens is only needed on sites with Exposure Zone D

**WINDOW JAMB
OPTION 1**

Detail Number
IC-V20-004.1

Version

[v1.6]



MATERIALS • SYSTEMS • SOLUTIONS

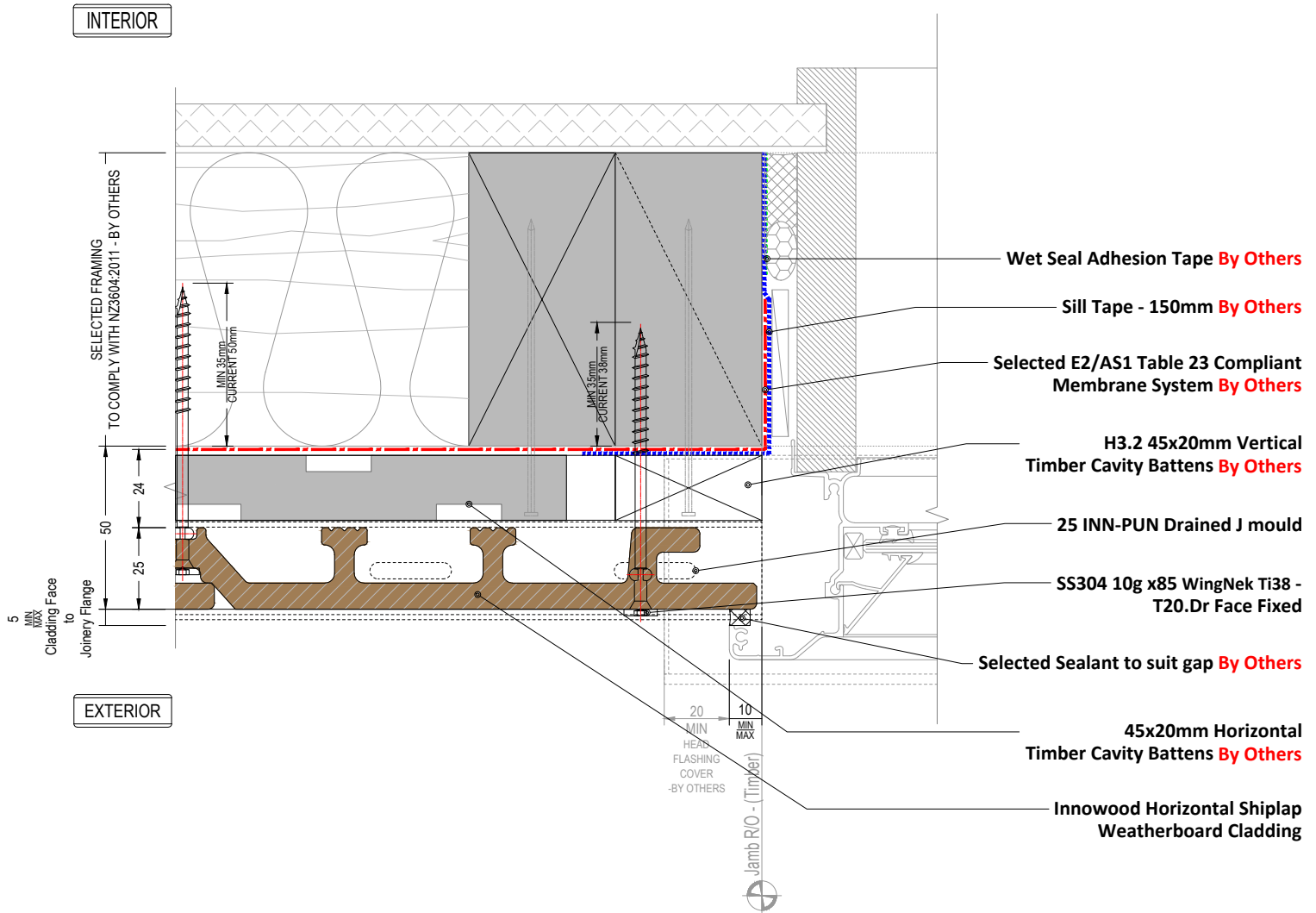

NOTE
 Careful consideration to window placement must be made in relation to cladding face to achieve minimal gap.
 Gaps greater than 5mm will require backing rod or support tape.
 Any sealant joints must meet manufacturers recommendation.

WINDOW JAMB OPTION 2

Detail Number

 IC-V20-004.2

Version

[v1.6]



MATERIALS • SYSTEMS • SOLUTIONS

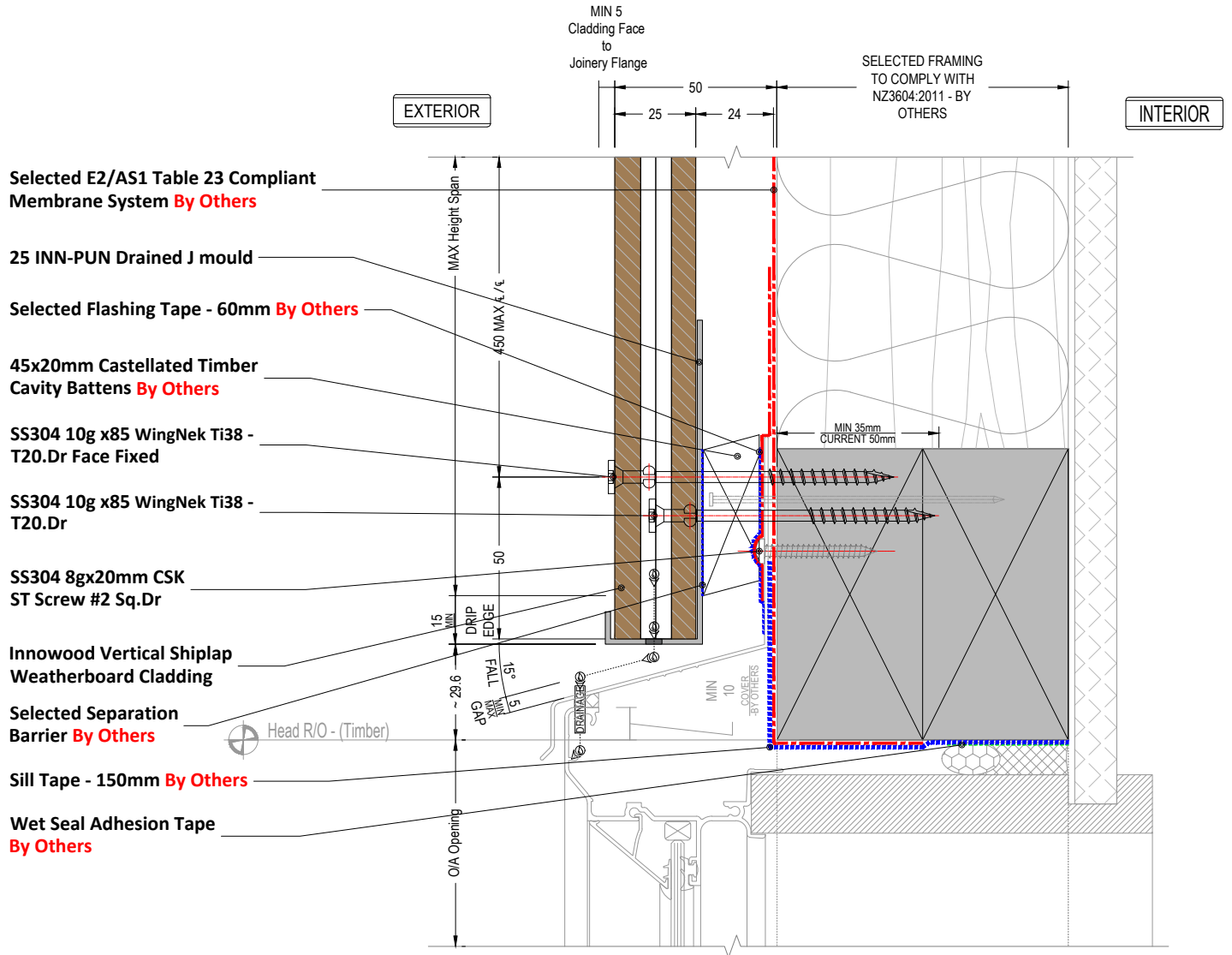

NOTE
 Careful consideration to window placement must be made in relation to cladding face to achieve minimal gap.
 Seal gaps of 5mm or greater W/ Suitable & Approved Sealant
 Selected Separation Barrier on Timber Batten is only needed on sites with Exposure Zone D

**WINDOW
HEAD**

Detail Number _____
 IC-V20-005
 Version _____

[v1.6]



MATERIALS • SYSTEMS • SOLUTIONS

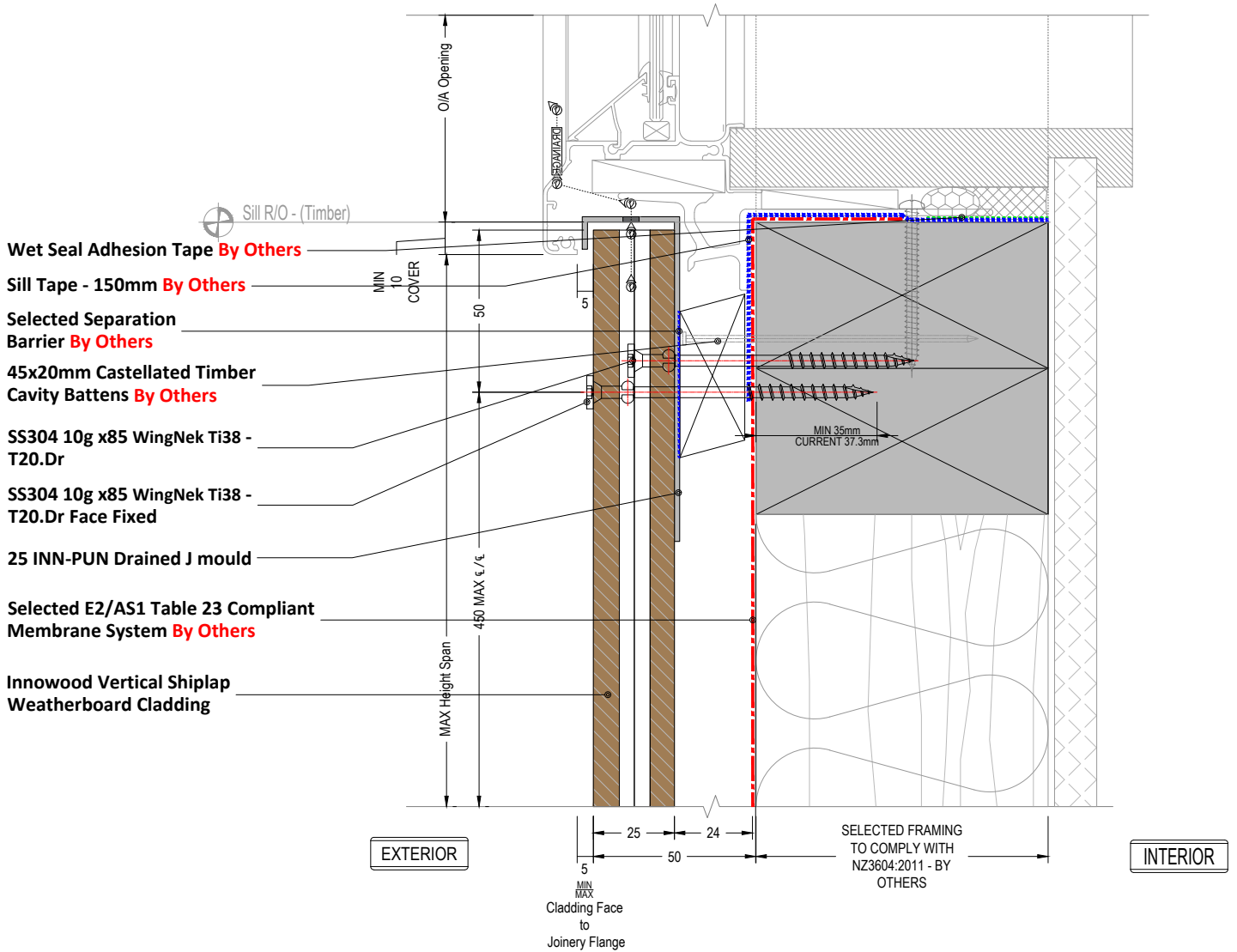

NOTE
Careful consideration to window placement must be made in relation to cladding face to achieve minimal gap.
Seal gaps of 5mm or greater W/ Suitable & Approved Sealant
Selected Separation Barrier on Timber Battens is only needed on sites with Exposure Zone D

WINDOW SILL OPTION 1

Detail Number
IC-V20-006.1

Version
[v1.6]

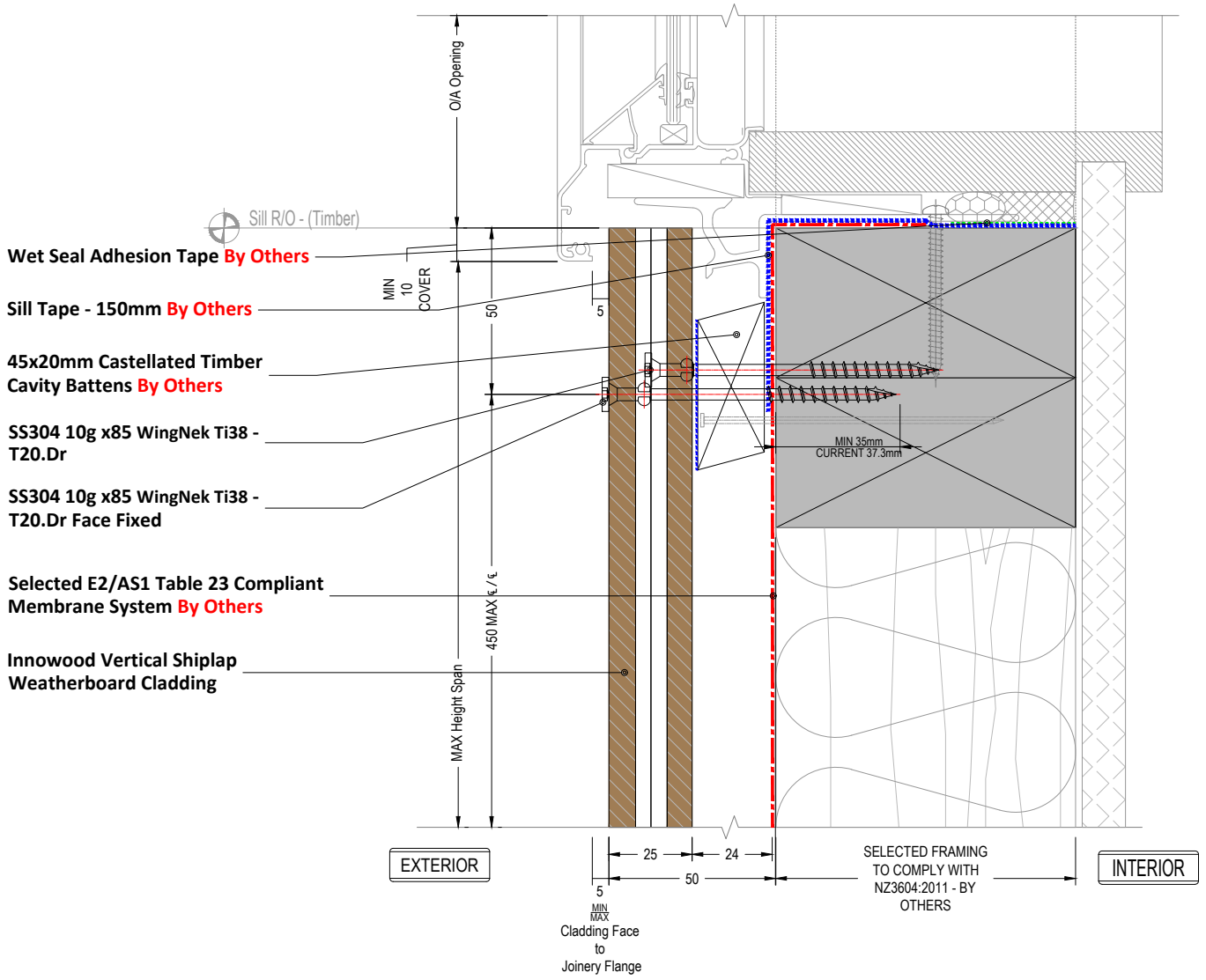

NOTE
Careful consideration to window placement must be made in relation to cladding face to achieve minimal gap.
Seal gaps of 5mm or greater W/ Suitable & Approved Sealant
Selected Separation Barrier on Timber Battens is only needed on sites with Exposure Zone D

**WINDOW SILL
OPTION 2**

Detail Number _____
IC-V20-006.2

Version _____
[v1.6]



MATERIALS • SYSTEMS • SOLUTIONS

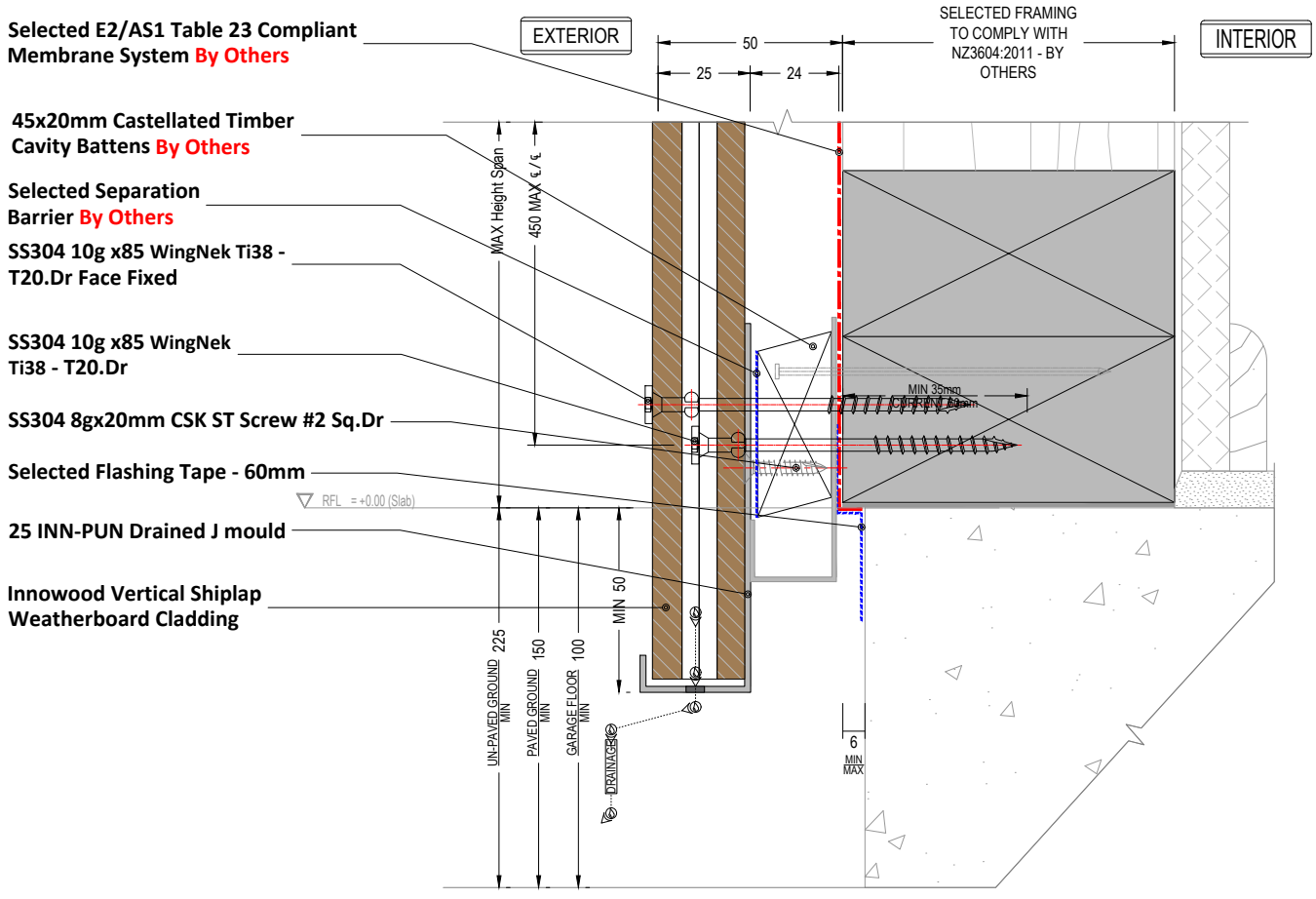

NOTE

Selected Separation Barrier on Timber Batten is only needed on sites with Exposure Zone D

FUNDATION TERMINATION

Detail Number _____
IC-V20-007

Version _____
[v1.6]



MATERIALS • SYSTEMS • SOLUTIONS

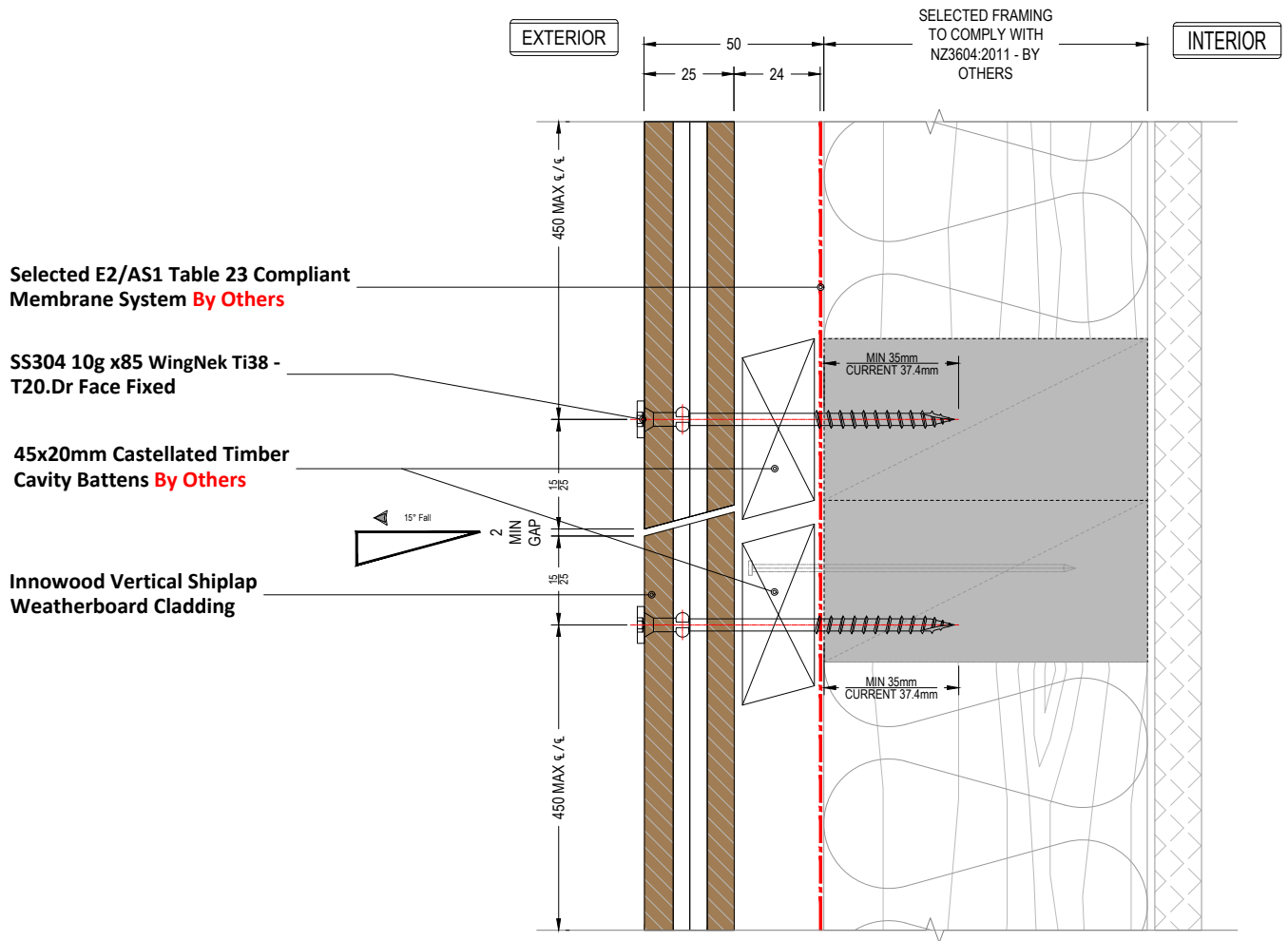

**HORIZONTAL
JOINT**

Detail Number
IC-V20-008

Version
[v1.6]



MATERIALS • SYSTEMS • SOLUTIONS

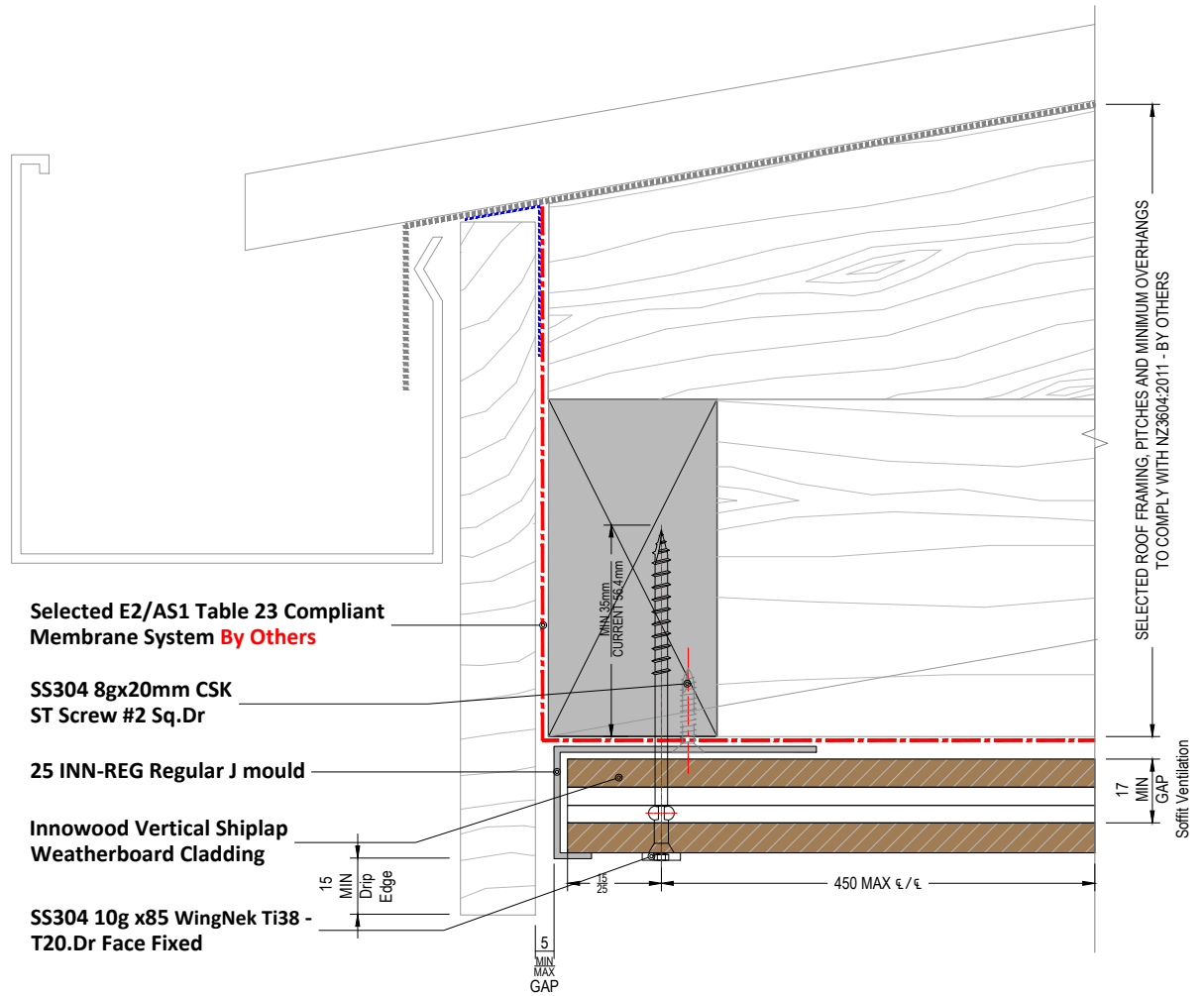

NOTE
Weathering Membrane under a soffit is not required, but is recommendable for air barrier performance when a rigid wind barrier is not in use

**FASCIA TO
SOFFIT / EAVE**

Detail Number _____
IC-V20-009
Version _____
[v1.6]



MATERIALS • SYSTEMS • SOLUTIONS

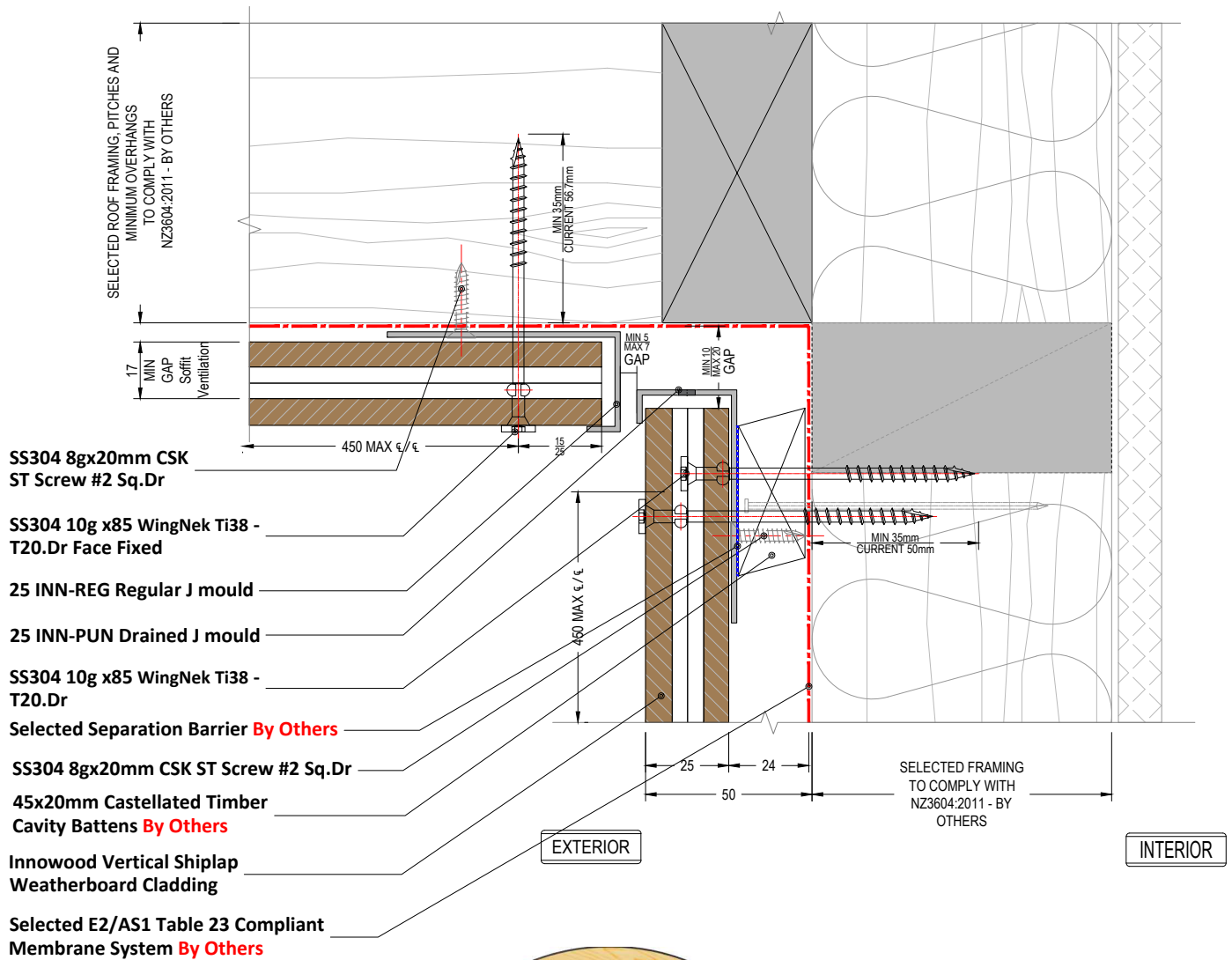

NOTE
Weathering Membrane under a soffit is not required, but is recommendable for air barrier performance when a rigid wind barrier is not in use
Selected Separation Barrier on Timber Batten is only needed on sites with Exposure Zone D

SOFFIT / EAVE TO WALL OP.1

Detail Number
IC-V20-010.1

Version

[v1.6]



MATERIALS • SYSTEMS • SOLUTIONS

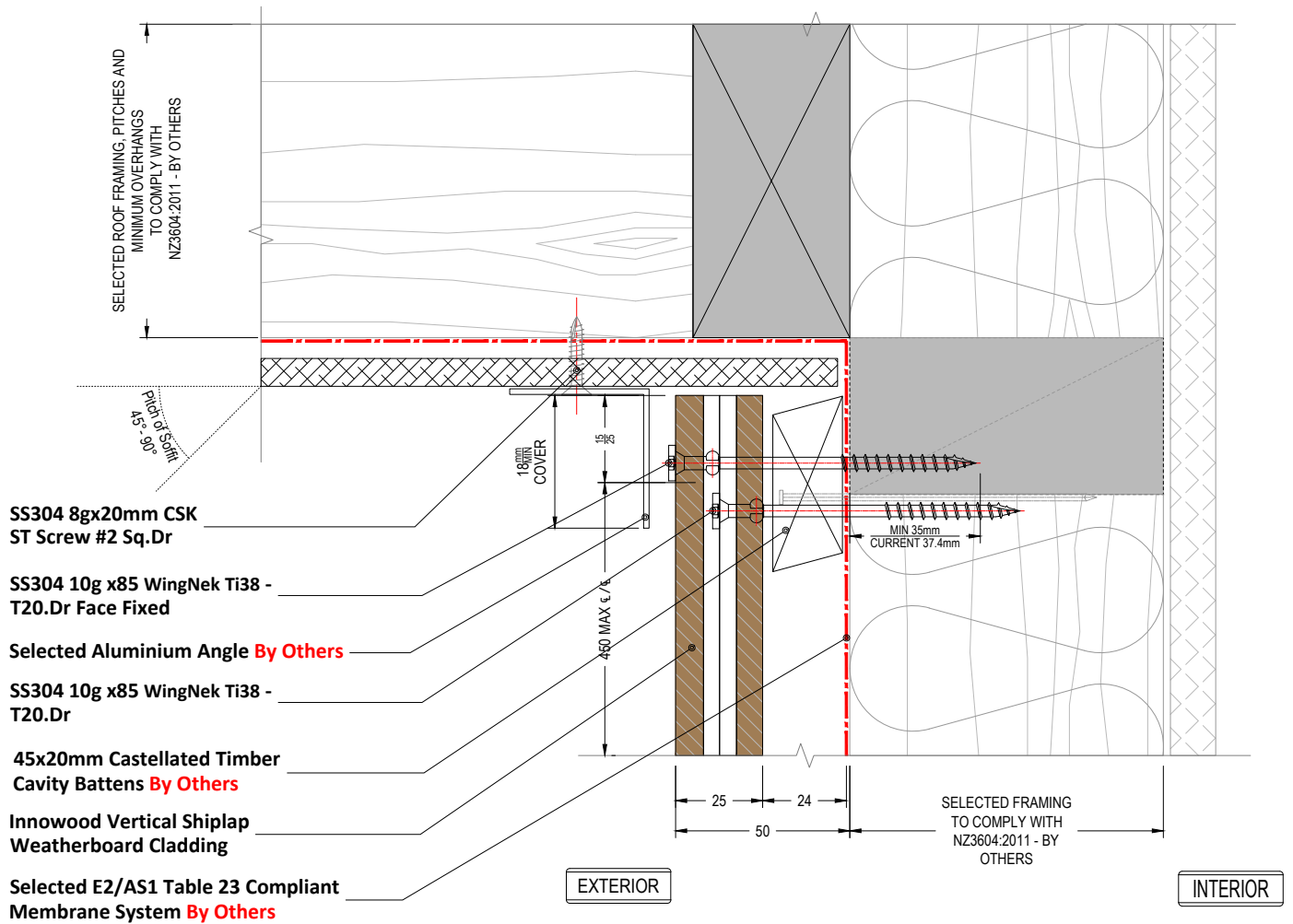

NOTE

Weathering Membrane under a soffit is not required, but is recommendable for air barrier performance when a rigid wind barrier is not in use

SOFFIT / EAVE TO WALL OP.2

Detail Number
IC-V20-010.2

Version
[v1.6]



MATERIALS • SYSTEMS • SOLUTIONS

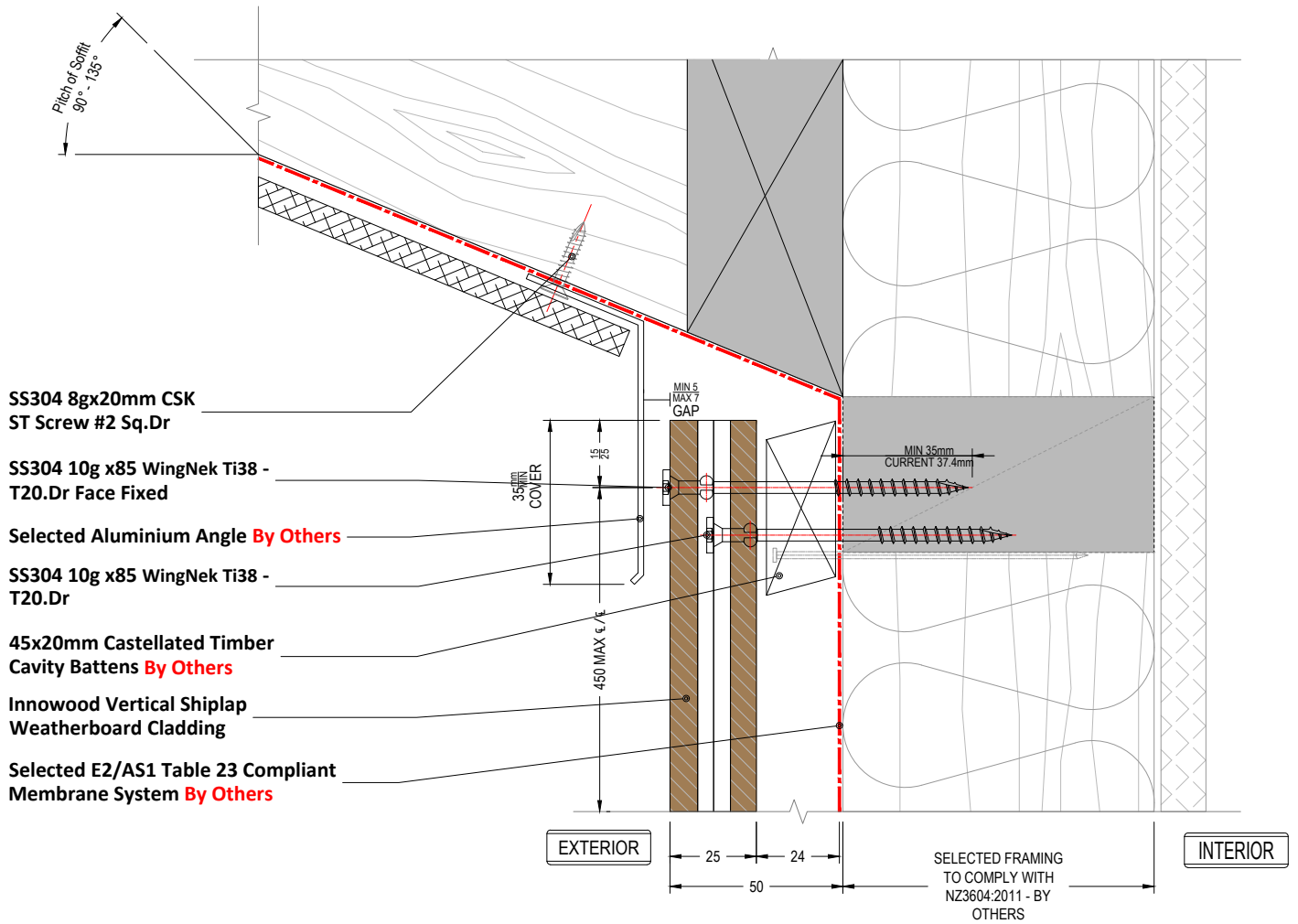

NOTE

Weathering Membrane under a soffit is not required, but is recommendable for air barrier performance when a rigid wind barrier is not in use

SOFFIT / EAVE TO WALL OP.3

Detail Number
IC-V20-010.3

Version
[v1.6]



MATERIALS • SYSTEMS • SOLUTIONS

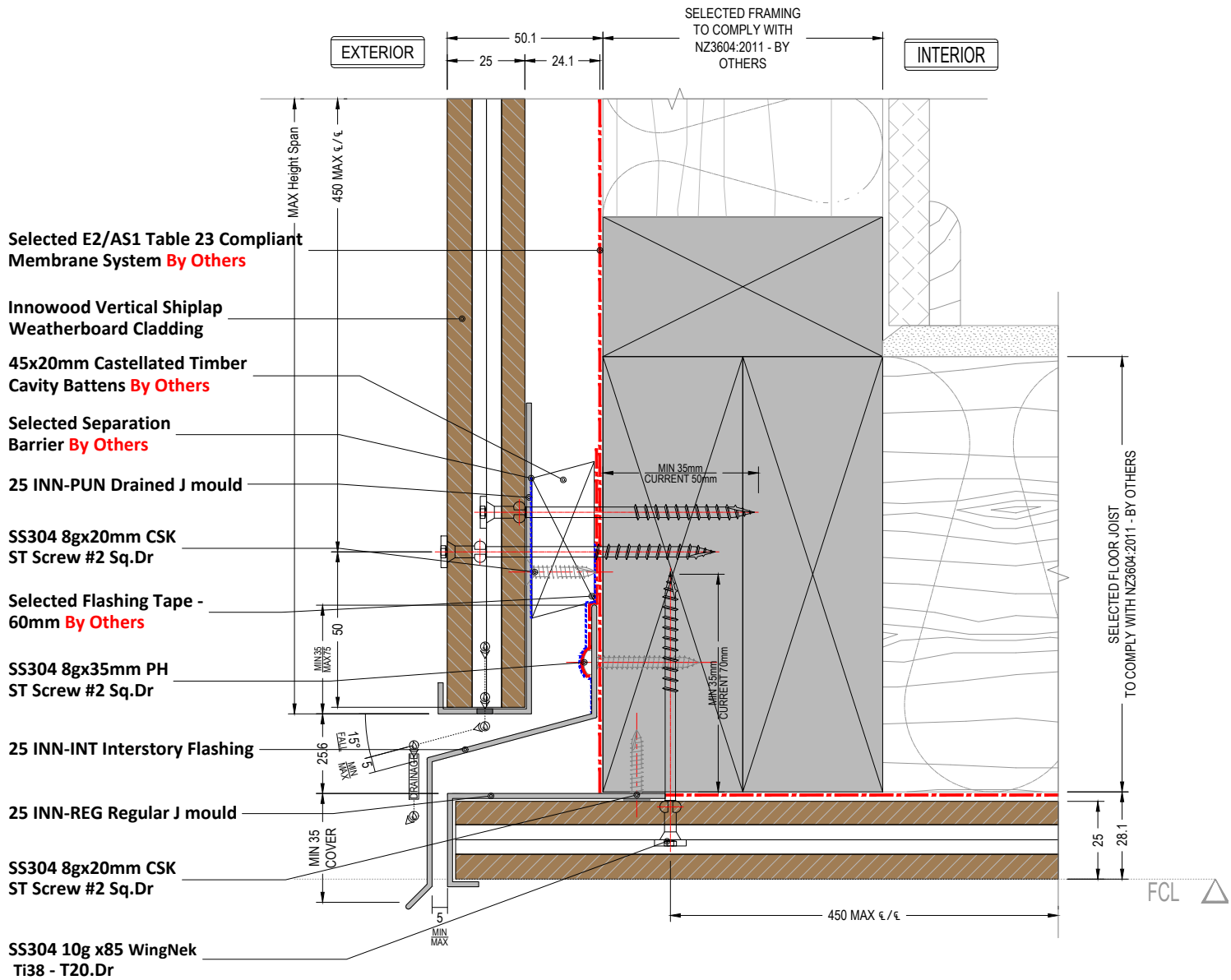

NOTE

Selected Separation Barrier on Timber Batten is only needed on sites with Exposure Zone D



WALL TO SOFFIT OP.1

Detail Number
IC-V20-011.1

Version

[v1.6]



MATERIALS • SYSTEMS • SOLUTIONS

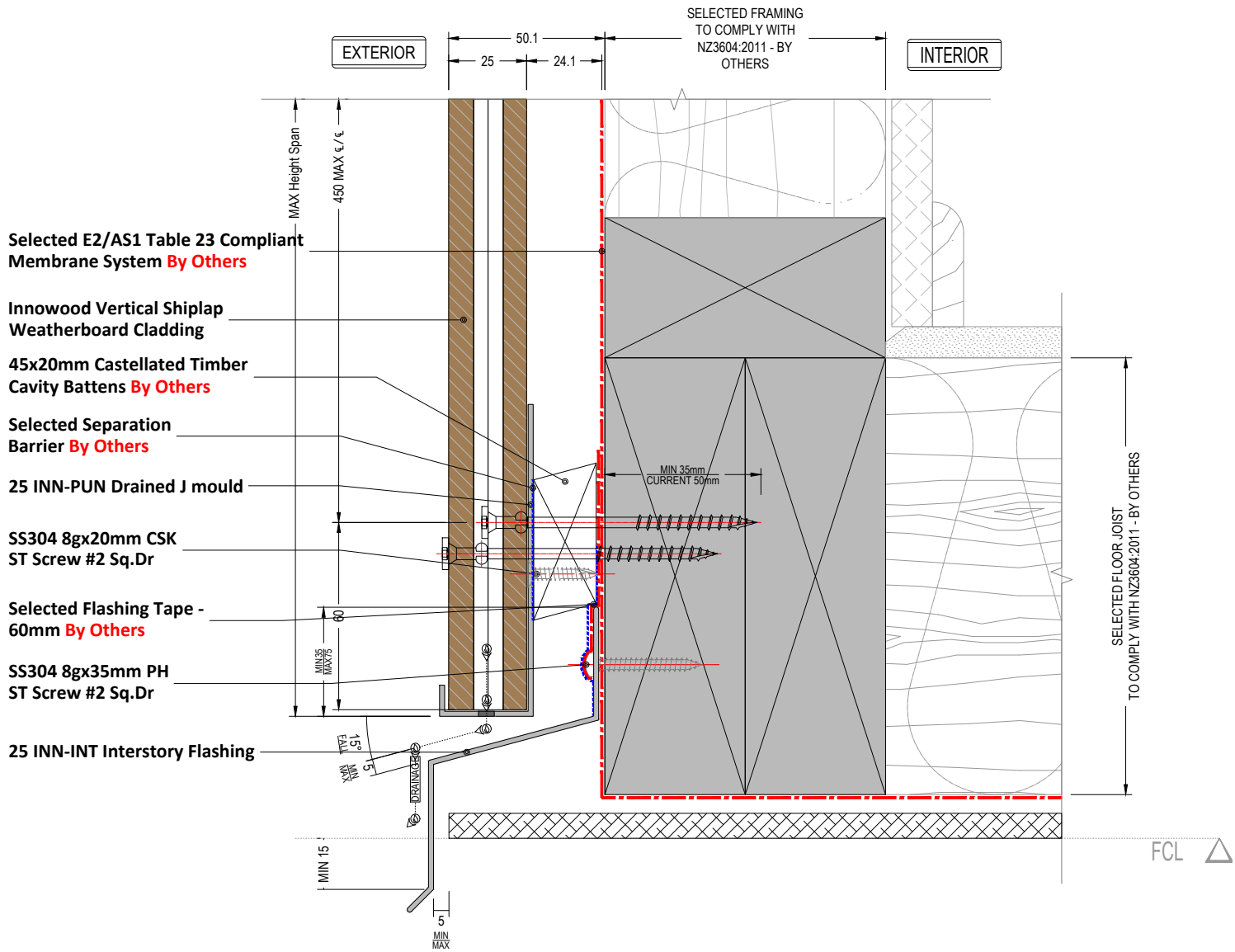

NOTE
Selected Separation Barrier on Timber Batten is only needed on sites with Exposure Zone D

WALL TO SOFFIT OP.2

Detail Number
IC-V20-011.2

Version
[v1.6]



MATERIALS • SYSTEMS • SOLUTIONS

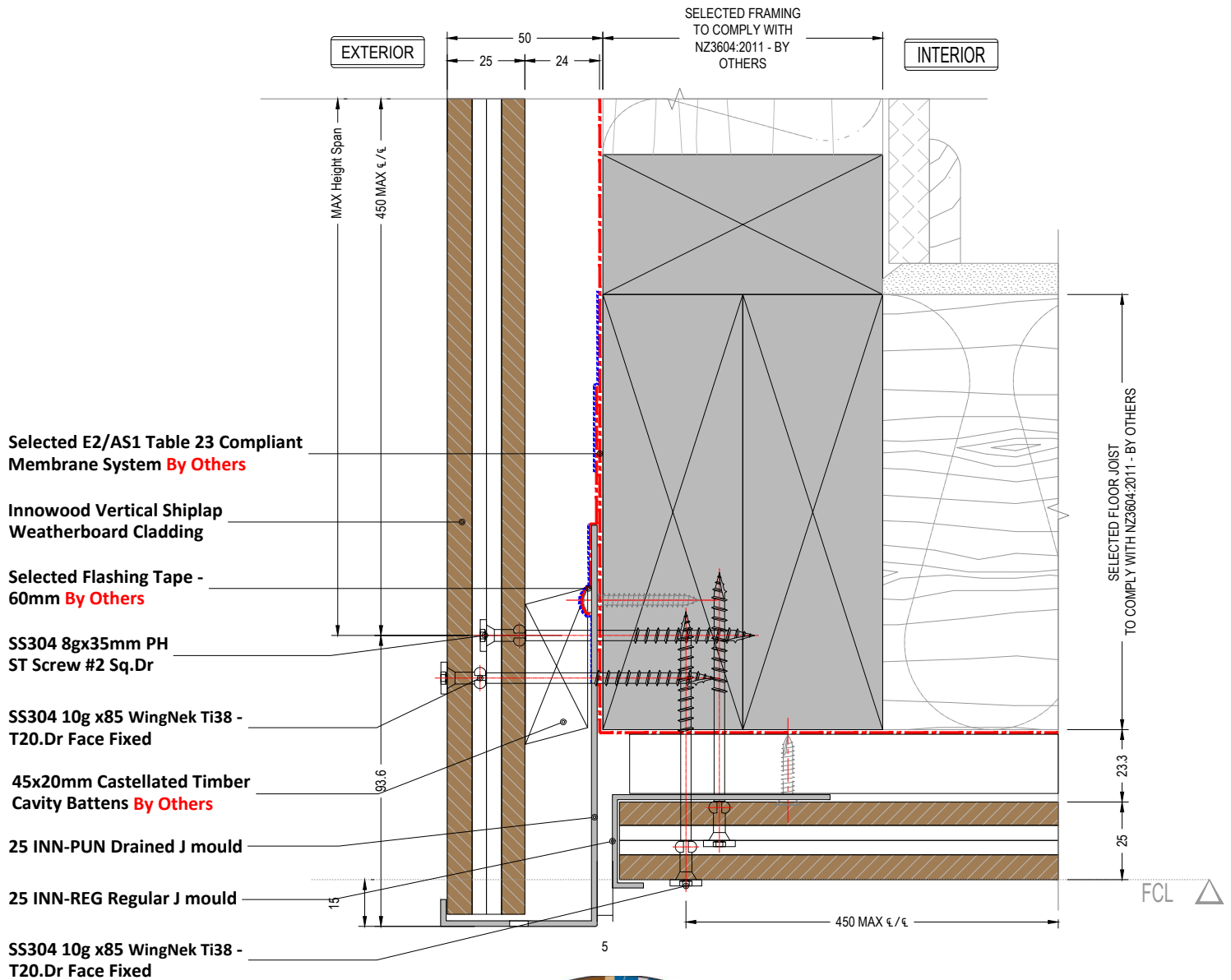

WALL TO
SOFFIT OP.3

Detail Number
IC-V20-011.3

Version
[v1.6]



MATERIALS • SYSTEMS • SOLUTIONS

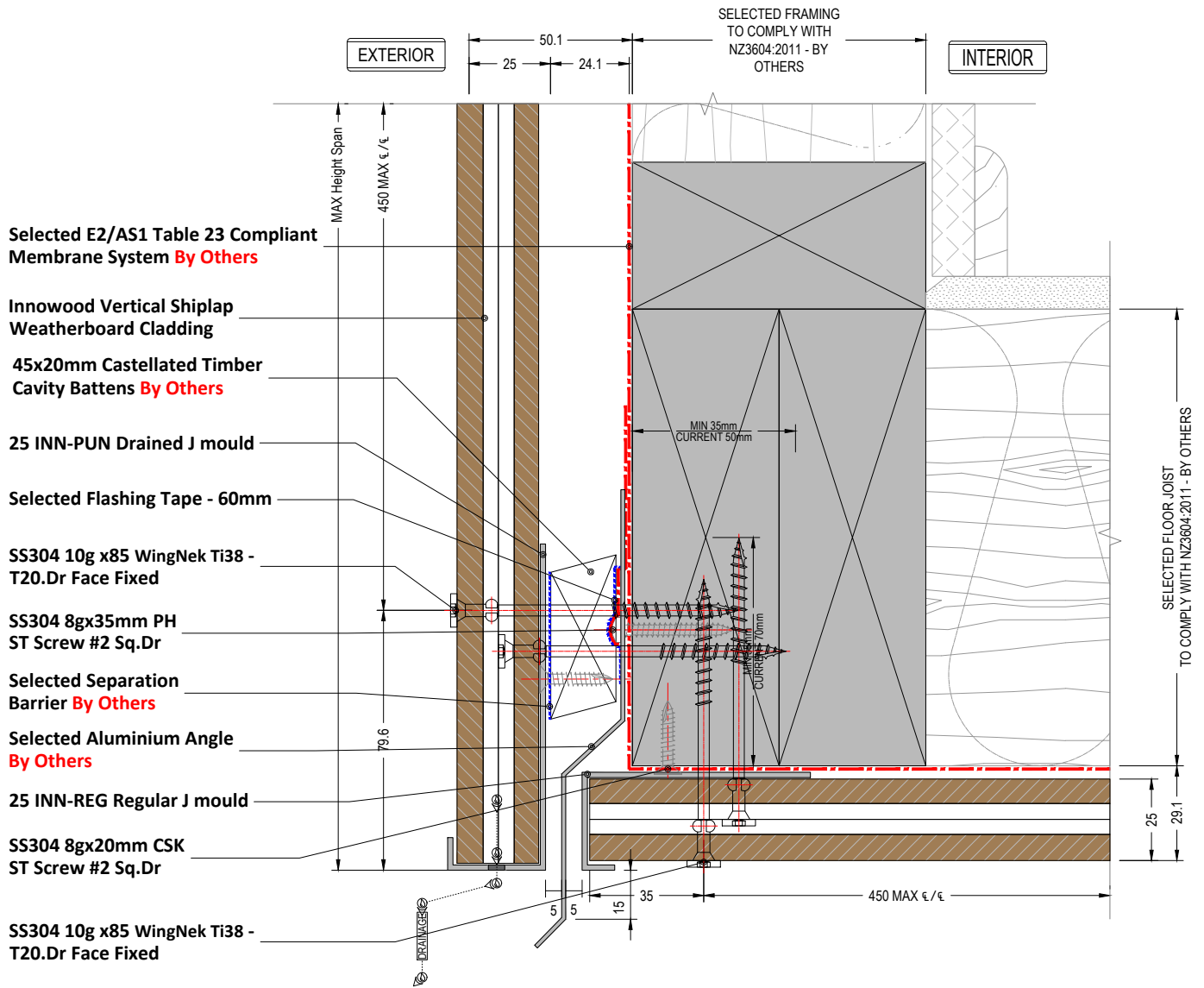

NOTE

Selected Separation Barrier on Timber Batten is only needed on sites with Exposure Zone D

WALL TO SOFFIT OP.4

Detail Number
IC-V20-011.4

Version
[v1.6]



MATERIALS • SYSTEMS • SOLUTIONS

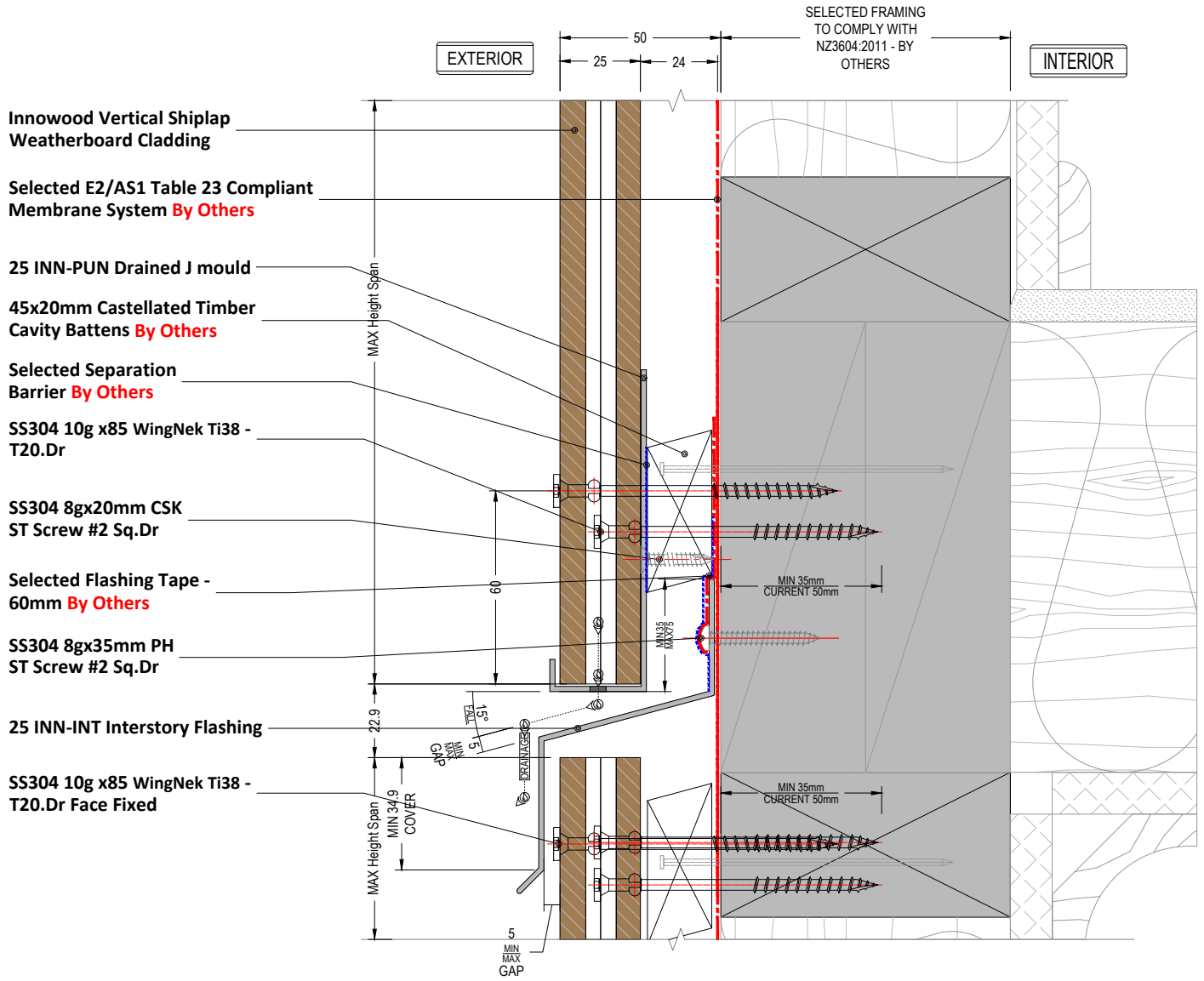

NOTE
Selected Separation Barrier on Timber Batten is only needed on sites with Exposure Zone D

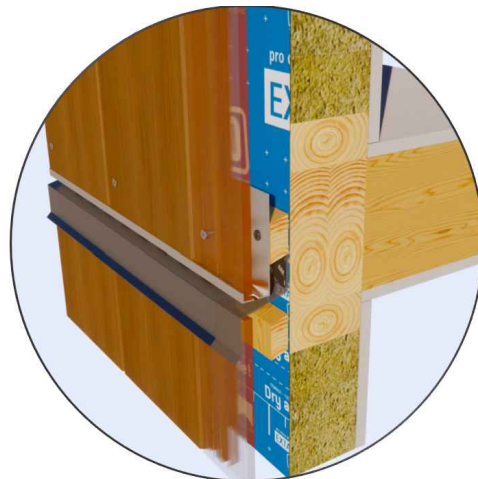

**INTER-STOREY
JUNCTION**

Detail Number
IC-V20-012

Version

[v1.6]



MATERIALS • SYSTEMS • SOLUTIONS

NZBC - Acceptable Solution E2/AS1:(2011)
Table 7 : Z Values for Parapet Capping Cover Selection

- Situation 1: Low, Medium, High wind zones, where roof pitch $\geq 10^\circ$ (X or Z values)
- Situation 2: All roof pitches in Very High wind zones, Low, Medium and High wind zones where roof pitch $\leq 10^\circ$ (X or Z values)
- Situation 3: For all roof pitches in Extra High wind zone

Selected Parapet Capping
Flashing **By Others**

Selected E2/AS1 Table 23
Compliant Membrane System
By Others

Innowood Horizontal Shiplap
Weatherboard Cladding

SS304 10g x85 WingNek Ti38 -
T20.Dr

45x20mm Castellated
Timber Cavity Battens
By Others

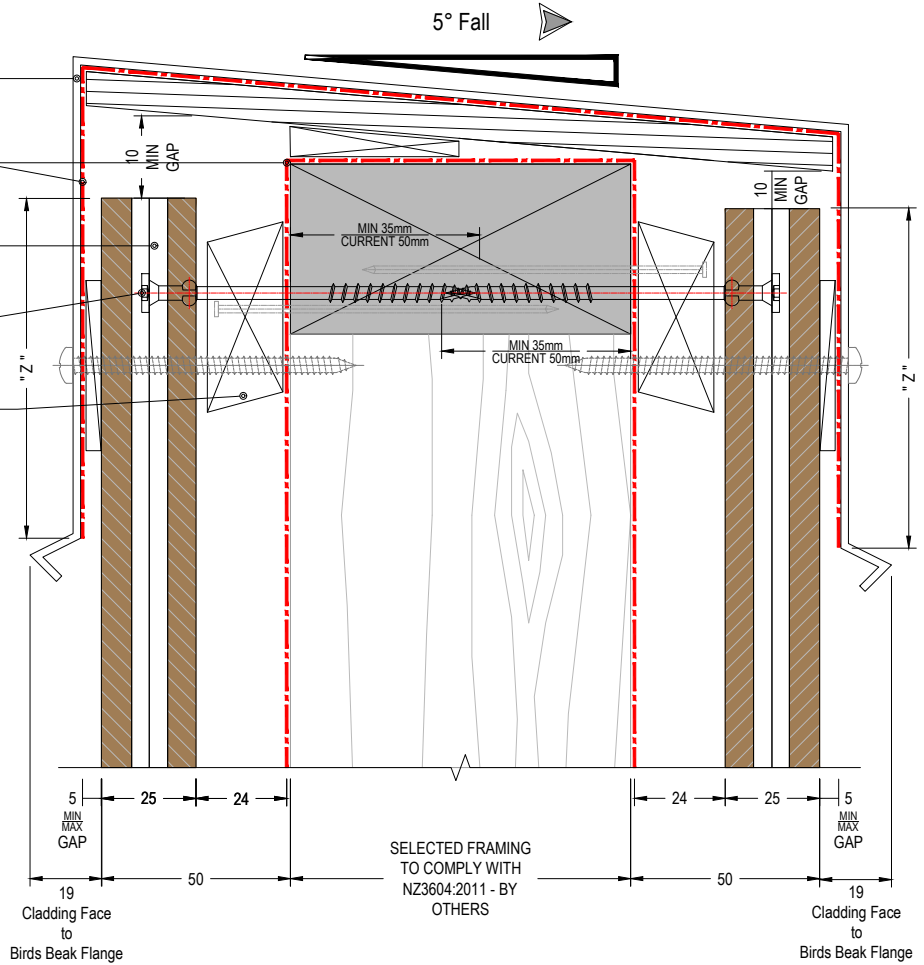

PARAPET CAPPING

Detail Number

IC-V20-013

Version

[v1.6]



MATERIALS • SYSTEMS • SOLUTIONS

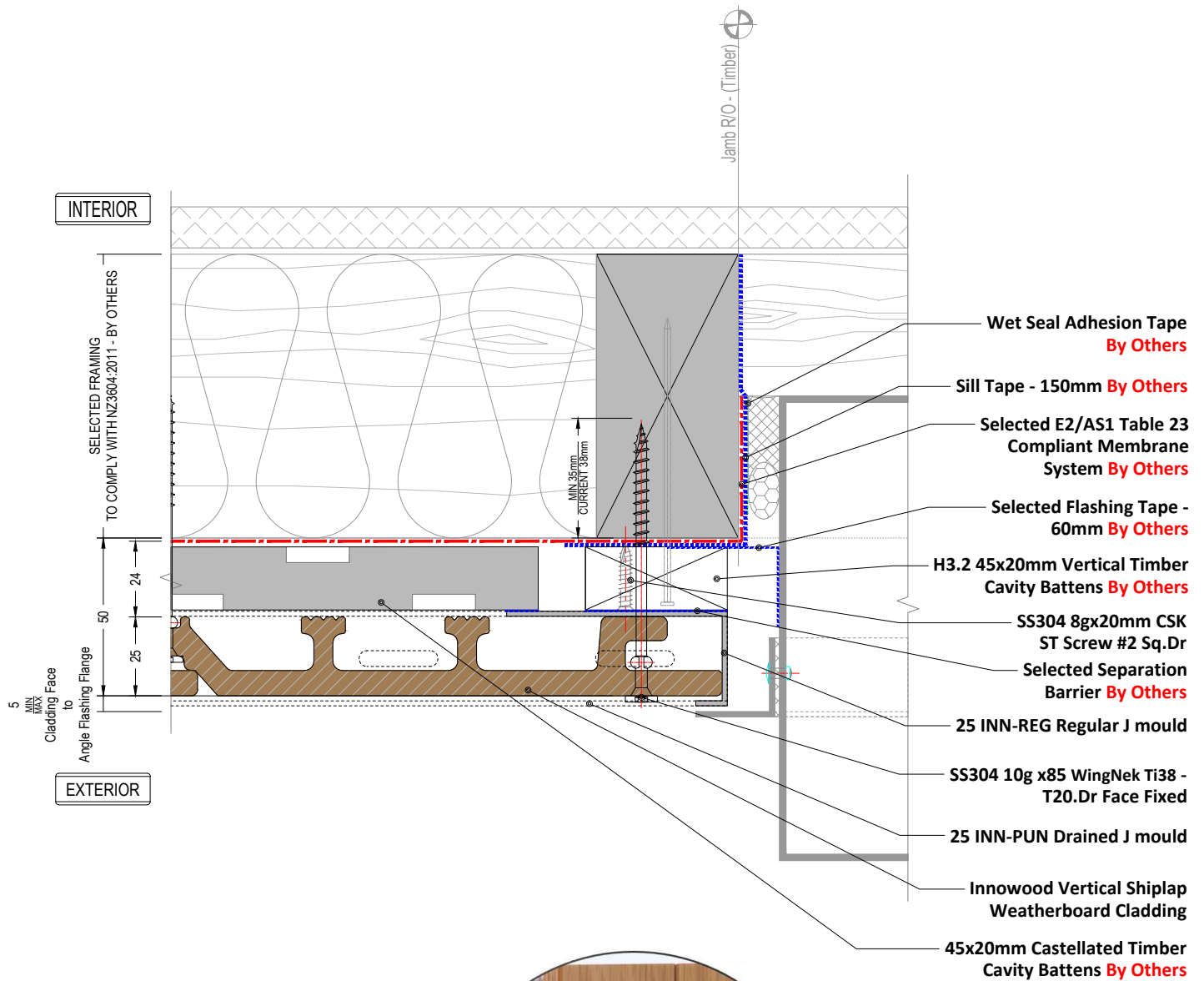

NOTE
Careful consideration to meterbox placement must be made in relation to cladding face to achieve minimal gap.
:Flashing Angle Bedsealed + Riveted
Seal gaps of 5mm or greater W/ Suitable & Approved Sealant
Selected Separation Barrier on Timber Batten is only needed on sites with Exposure Zone D

**METERBOX
JAMB**

Detail Number
IC-V20-014.1

Version
[v1.6]



MATERIALS • SYSTEMS • SOLUTIONS

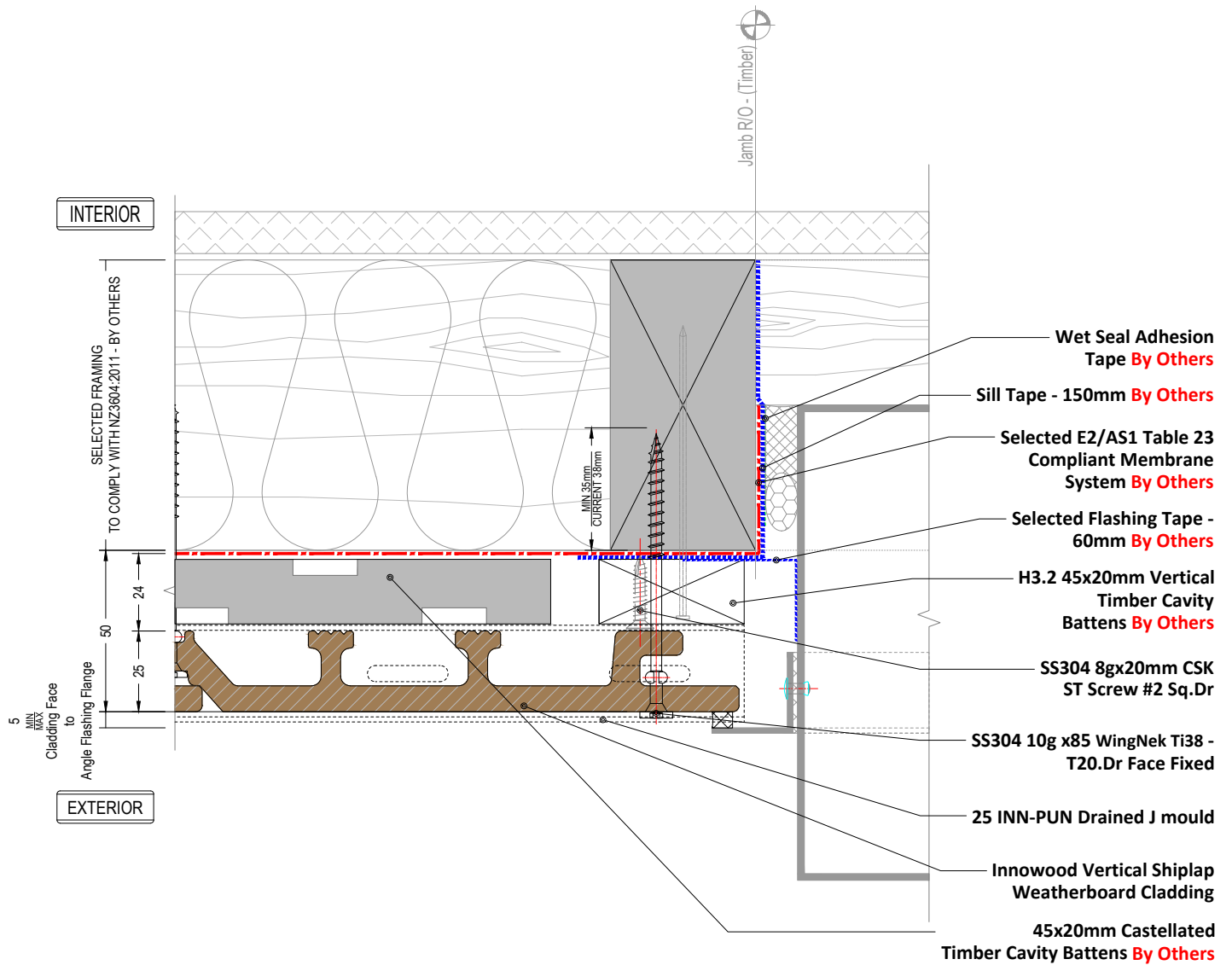

NOTE
Careful consideration to meterbox placement must be made in relation to cladding face to achieve minimal gap.
:Flashing Angle Bedsealed + Riveted
Seal gaps of 5mm or greater W/ Suitable & Approved Sealant

**METERBOX
JAMB**

Detail Number _____
IC-V20-014.2

Version _____

[v1.6]



MATERIALS • SYSTEMS • SOLUTIONS

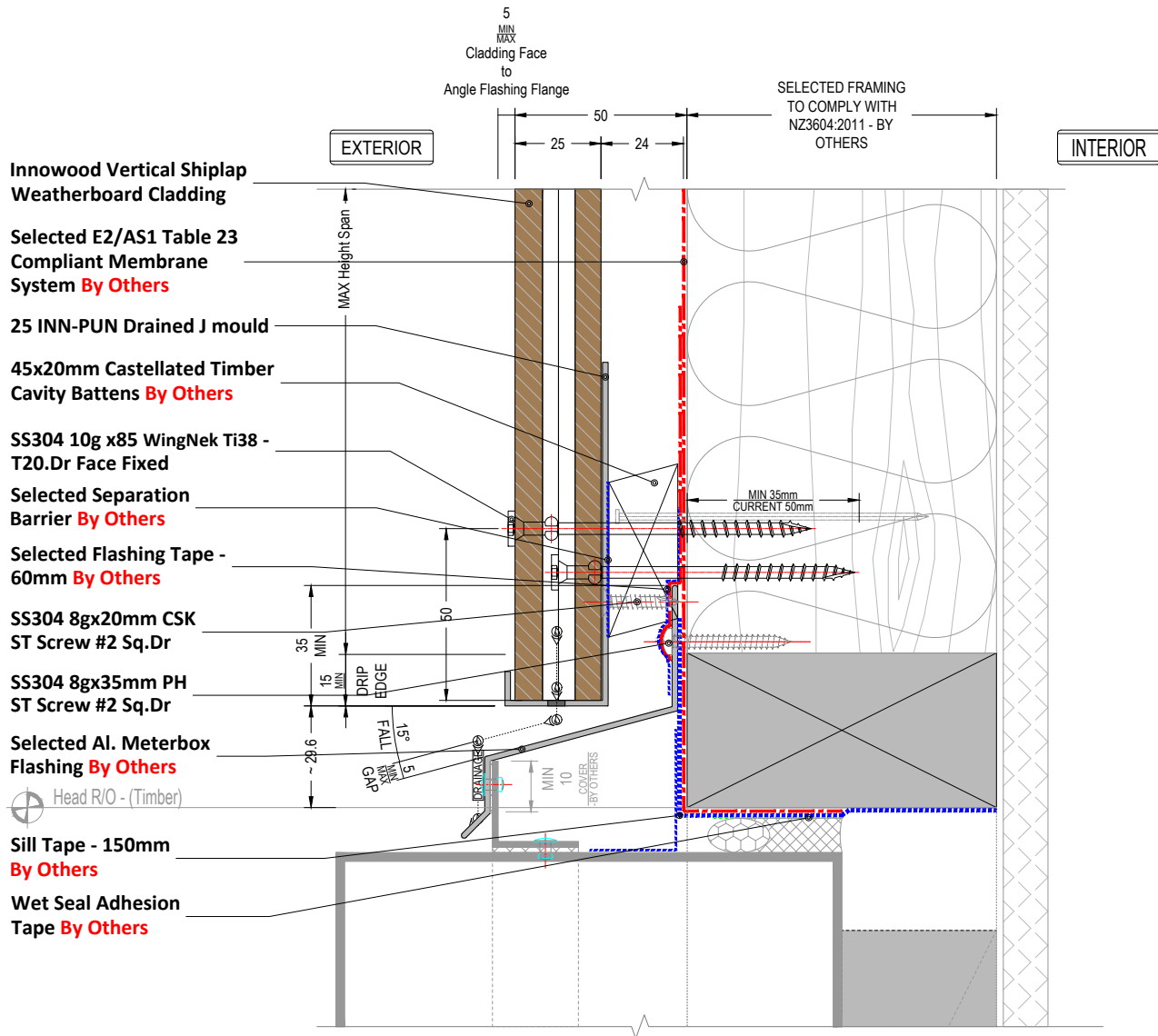

NOTE
Careful consideration to meterbox placement must be made in relation to cladding face to achieve minimal gap.
:Flashing Angle Bedsealed + Riveted
Seal gaps of 5mm or greater W/ Suitable & Approved Sealant
Selected Separation Barrier on Timber Batten is only needed on sites with Exposure Zone D

METERBOX
HEAD

Detail Number
IC-V20-015
Version
[v1.6]



MATERIALS • SYSTEMS • SOLUTIONS

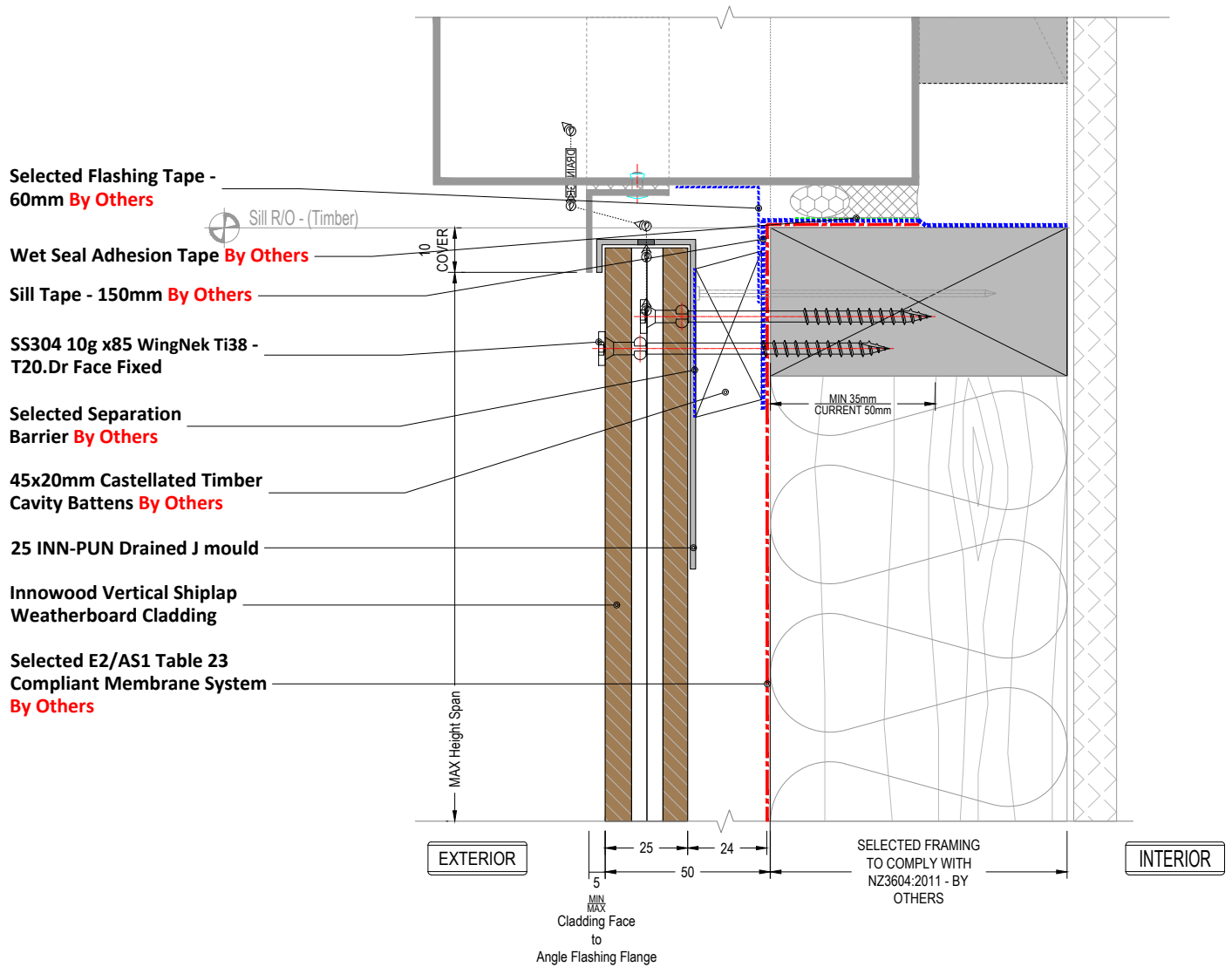

NOTE
Careful consideration to meterbox placement must be made in relation to cladding face to achieve minimal gap.
:Flashing Angle Bedsealed + Riveted
Seal gaps of 5mm or greater W/ Suitable & Approved Sealant
Selected Separation Barrier on Timber Batten is only needed on sites with Exposure Zone D

METERBOX SILL OP.1

Detail Number
IC-V20-016.1

Version
[v1.6]



MATERIALS • SYSTEMS • SOLUTIONS

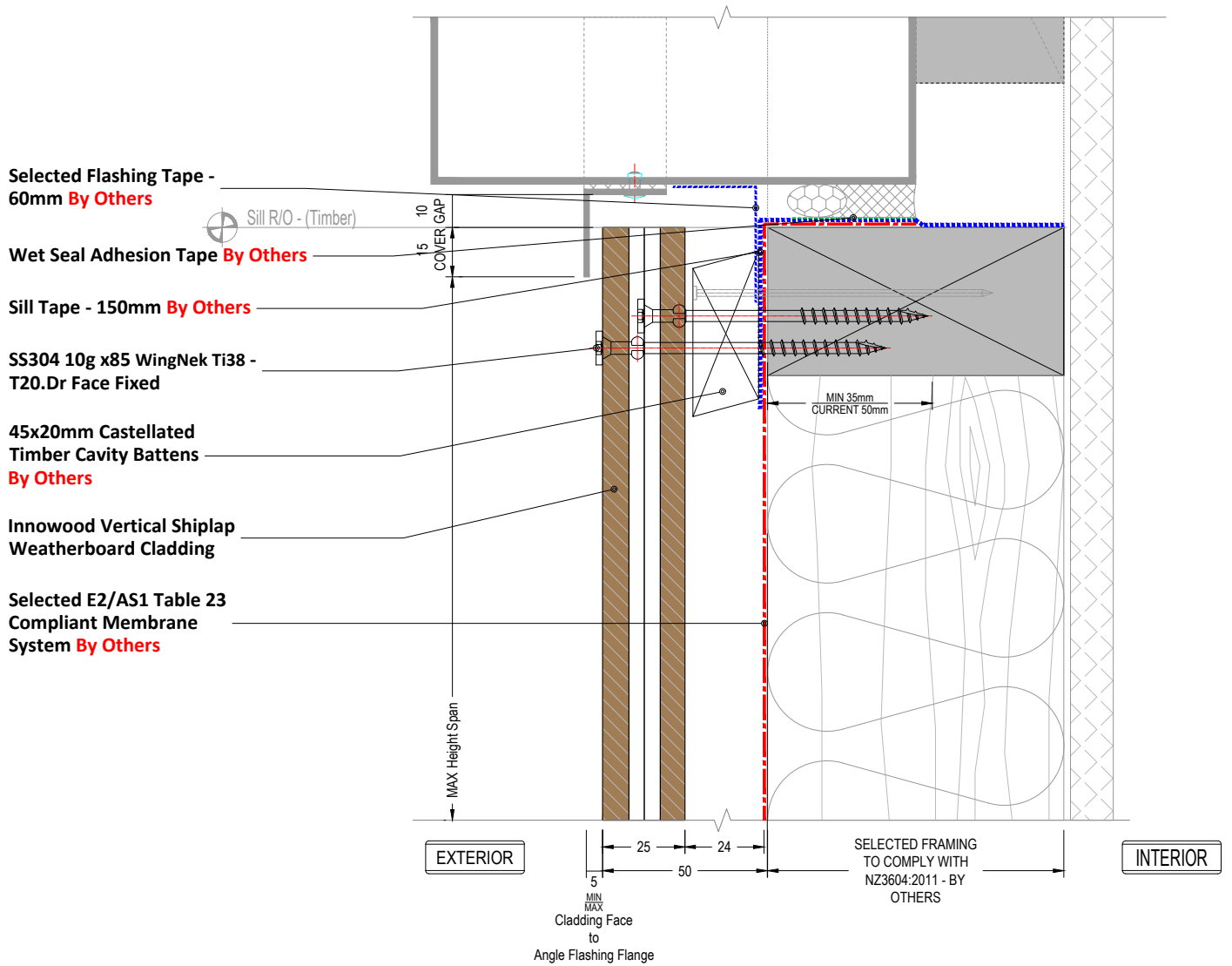

NOTE
Careful consideration to meterbox placement must be made in relation to cladding face to achieve minimal gap.
.:Flashing Angle Bedsealed + Riveted
Seal gaps of 5mm or greater W/ Suitable & Approved Sealant

**METERBOX
SILL OP.2**

Detail Number
IC-V20-016.2

Version
[v1.6]



MATERIALS • SYSTEMS • SOLUTIONS

Selected E2/AS1 Table 23
Compliant Membrane System
By Others

45x20mm Castellated
Timber Cavity Battens
By Others

SS304 10g x85 WingNek Ti38 -
T20.Dr Face Fixed

Selected Sealant to
suit gap **By Others**

5
MIN
GAP

23

MIN 35mm
CURRENT 37.5mm

PIPE MINIMUM

5° Fall

Sill Tape - 150mm
By Others

SS304 10g x85 WingNek
Ti38 - T20.Dr

SS304 10g x85 WingNek Ti38 -
T20.Dr Face Fixed

Innowood Vertical Shiplap
Weatherboard Cladding

5
MIN
GAP

25

MIN 35mm
CURRENT 36.3mm

SELECTED FRAMING
TO COMPLY WITH
NZ3604:2011 - BY
OTHERS

10
MIN
Cladding Face
to
Pipe End

25

24

50



**PIPE (CIRCULAR)
PENETRATION**

Detail Number

IC-V20-017

Version

[v1.6]





MATERIALS • SYSTEMS • SOLUTIONS

9. - Document Control

InnoWood Vertical V-Joint 25mm Cladding
Installation Manual: New Zealand
20mm Cavity

9.1 Installation Manual - Revisions

- [v1.6] - AUG 2023 : Current
- [v1.5] - NOV 2021
- [v1.4] - JUL 2020
- [v1.3] - MAR 2020
- [v1.2] - FEB 2020
- [v1.1] - SEPT 2019
- [v1.0] - JUL 2019

9.2 Compliance Documentation

