

# INNOCLAD

SHIPLAP FIXING  
HORIZONTAL  
INSTALLATION MANUAL

WC13625  
WC20025  
WC24025



№19111



THE  
BUILDING AGENCY

V1.5 2023

# CONTENTS

1. Scope and Application	1
2. Shiplap Innowood Parts	2
3. Site Storage and Product Handling	3
4. General Remarks	3
4.1. Thermal Movements	3
4.2. Bear In Mind That	3
4.3. Site and Foundation	4
4.4. Surface Clearances	4
4.5. Moisture Management	4
4.6. Ventilation	4
4.7. Minimum Cavity Space	5
4.8. Installing Above Reflective Surfaces	5
4.9. Expansion Joints	5
5. Framing Options	6
5.1. Direct Fix into Timber	6
5.2. Timber Battens	6
5.3. Galvanized Steel Framing	6
5.3. Aluminium Framing	7
6. Details	7



THE  
BUILDING AGENCY

# 1. SCOPE AND APPLICATION

INNOWOOD cladding installed as per this specification provides a durable and natural cladding with a timber appearance for use in residential and commercial buildings. The product can be installed over a timber, galvanized steel or aluminium support structure (for selection see page 6). Assure that you follow the design, preparation and installation guidelines of this manual. It is your responsibility to check if you have the latest version of the manual. Updates can be found on the website [www.spsbuilding.co.nz](http://www.spsbuilding.co.nz)

This manual covers the use of INNOWOOD as a cladding solution in wind zones up to 2.5 kPa ULS in the region of New Zealand. For projects outside of this scope, please contact The Building Agency. It is the designer's responsibility to review the project requirements of the cladding including (but not limited to) fire, bracing, acoustic, thermal and structural and check that INNOWOOD will comply with these requirements.

## BEFORE YOU START:



**Please note** that the product is subject to natural variation\* in finish as part of the manufacturing process. The purchaser or builder/installer is responsible for inspecting the colour, finish and size of the product prior to installation as well as identifying whether the product has any defects or manufacturing faults.

Ensure the product meets surface appearance and product specification requirements. Subject to the terms of our warranty, INNOWOOD is not liable for claims made after the installation of the product that relate to surface appearance and product specification.

INNOWOOD product is made predominantly from a timber bi-product. The colour will vary up to 20% +/- according to the timber used in its manufacture. It is the responsibility of the specifier or other party to ensure that the information in this manual is appropriate for the intended application and further design detailing may have to be made for specific applications that fall outside the scope of the manual.

Information contained on this document is the copyright of The Building Agency. Use or copying of this document in whole or in part without the written permission of The Building Agency is not permitted.

**It is important during installation to take boards from various boxes to create a natural variation in tone.**



# 2. SHIPLAP INNOWOOD PARTS

## Installation Tips and Requirements



INNOWOOD products can be worked with ordinary woodworking tools such as:

- Circular Saw
- Crosscut Mitre Saw
- Carpenters Square
- Cordless Drill
- Level & Chalk Line
- Tape Measure

## PROFILE OPTIONS

			
			
Product Code	WC13625	WC20025	WC24025
Coverage	105mm	165mm	205mm
Support Centres	External Use: 450mm Internal Use: 600mm	External Use: 450mm Internal Use: 600mm	External Use: 450mm Internal Use: 600mm

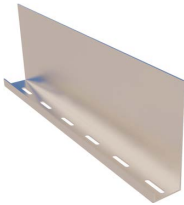
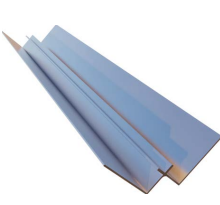
## ACCESSORY OPTIONS

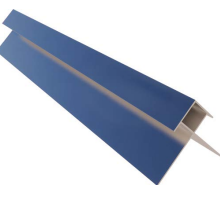
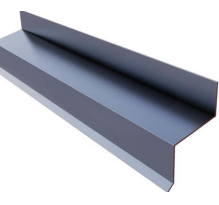
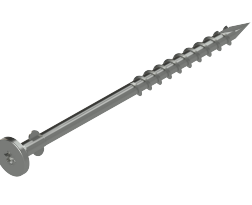
					
J Mould Drained	W Mould— Internal Corner	J Mould	External corner	Inter-storey 20mm batten	Innowood Timber Screw -10gx85mm SS (A2) -10gx50mm SS (A2)



# 3. SITE STORAGE AND PRODUCT HANDLING

**IMPORTANT: INNOWOOD boards should not be stored in the open or wrapped or covered with plastic sheet. They should be stored under cover and protected from the elements (including direct sunlight and rain) until ready to install. Remove any plastic wrap including shrink wrap and store on a dry and flat surface supported at max 450mm centres.**

- When removing INNOWOOD boards from the pack, do not slide boards against each other, lift the boards and set them down carefully.
- INNOWOOD boards should be carried on their edge for better support and take care to avoid scratches, nicks and other damage to the boards.
- INNOWOOD boards are a finished product, do not dump or drop when loading or unloading, always handle with care.
- If you are intending to use off-cuts, the same storage and handling applies.

NOTE: To ensure long-term performance, all installation needs to be performed by either LBP or installers that are trained and certified by The Building Agency and the Building Training Academy.

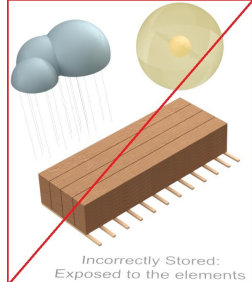
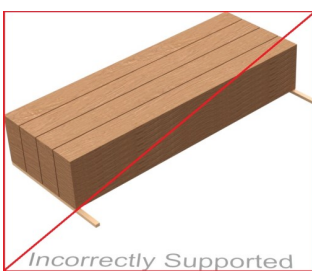
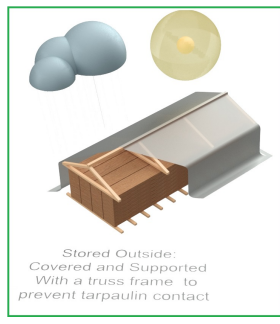
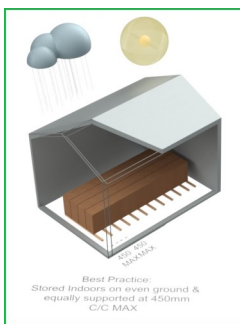

# 4. GENERAL REMARKS

## 4.1. THERMAL MOVEMENTS

Any wood based products will expand and contract with changes in temperature. The amount of expansion varies according to the amount of change in temperature. Although thermal movements are reversible, these movements due to temperature change may vary by up to 2mm per meter.

INNOWOOD boards that have been exposed to direct sun for several hours, prior to installation will have expanded more than boards left in the shade. Its important to maintain an average consistent temperature for all boards as they are being installed. Avoid installing in full sun if ambient temperature is above 30°C.

Ensure the boards are kept out in the sun until installed to limit the boards expansion prior to installation. INNOWOOD products can tolerate a temperature range from -20°C to +65°C. If the product is to be used in an environment outside of this temperature range please consult The Building Agency.

## 4.2 BEAR IN MIND THAT:

- Where face fixing is required, clearance holes must be pre drilled. The clearance hole drilled must be slightly greater than the outside screw thread diameter.
- Only proprietary The Building Agency screws can be used to fix the INNOWOOD cladding.
- Screws must be a minimum 15mm but maximum 25mm away from board edges (unless noted otherwise).
- INNOWOOD products must not be used for any structural purpose.
- The cut surface must be sealed with a layer of protective coating such as a water based deck sealer before installation.
- When exposed to direct sunlight, surface temperature may be significantly hotter than ambient temperature.

# 4.3 SITE & FOUNDATION

The site in which the building is situated must comply with the NZBC Acceptable Solution E1/AS1 'Surface Water'. Foundations design must comply with the requirements of NZS3604 'Timber-framed Buildings' or be as per specific engineering design.

The grade of adjacent finished ground must slope away from the building to avoid any possibility of water accumulation in accordance with the NZBC requirements.

# 4.4 GROUND CLEARANCES

The clearance between the bottom edge of cladding and paved/unpaved ground must comply with section 9.1.3 of E2/AS1. The finished floor level must also comply with these requirements. These clearances must be maintained throughout the life of the building.

INNOWOOD must overhang the bottom plate on a concrete slab by a minimum of 50mm as required by NZS3604.

INNOWOOD must have a minimum clearance of 100mm from paved ground, and 175mm from unpaved ground. On roofs and decks, the minimum clearance must be 50mm. Do not install external cladding in such a way that at any point it may come into and remain in contact with water or ground.

# 4.5 MOISTURE MANAGEMENT

It is the responsibility of the specifier to identify moisture related risks associated with any particular building design.



Wall construction design must effectively manage moisture, considering both the interior and exterior environments of the building, particularly in buildings that have a higher risk of wind driven rain penetration or that are artificially heated or cooled.

Walls must include those provisions as required by the NZBC Acceptable Solution E2/AS1 'External Moisture'. In addition all wall openings, penetrations, junctions, connections, windowsills, heads and jambs must incorporate appropriate flashings for waterproofing.

The other materials, components and installation methods used to manage moisture in external walls, must comply with the requirements of relevant standards and the NZBC.

# 4.6 VENTILATION

INNOWOOD Cladding requires airflow through the cavity from bottom to top, which is achieved via airflow openings at the top and bottom of the installation.

For an installation with cladding orientated horizontally, it is necessary to use a castellated batten horizontally to allow the air to flow behind. Depending on the situation the example most suitable from the diagram below should be implemented.

For flashing sizes consult the typical details in section 6.

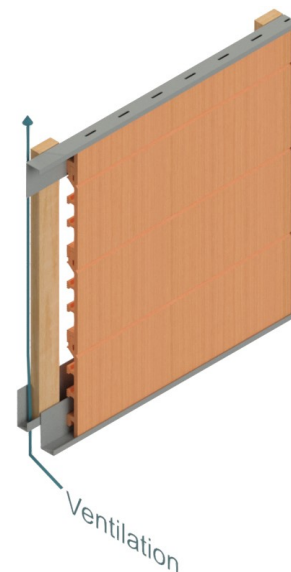

# 4.7 MINIMUM CAVITY SPACE

INNOWOOD cladding must be installed onto battens or top hats so as to achieve a cavity between boards and back structure. This spacing and cavity requirements assists in preventing the boards from over heating and potentially warping.

Minimum Wall Cavity Size: 35mm (including thermal break if applicable)

Minimum Soffit Cavity Size: 15mm

# 4.8 INSTALLING ABOVE REFLECTIVE SURFACES

Reflective surfaces such as metal roofing can add to the heat load of the cladding due to UV rays reflecting off the surface, which may adversely affect the INNOWOOD product under normal installation conditions. Therefore additional supports must be used to counter this as follows:



Any cladding which is above a metal roof requires the battens to be installed at maximum 225mm centres for any area of cladding which is within a 1.2m radius of the metal roof (in any direction).

# 4.9 EXPANSION JOINTS

Never span cladding across expansion joints in structure. If necessary terminate the cladding on either side of any expansion joint to prevent damage to the cladding and/or structure.





# 5. FRAMING OPTIONS

INNOWOOD can be fixed over the following support options:

## 5.1 DIRECT FIX INTO TIMBER

### SCOPE:

- Buildings within scope limitations of Acceptable Solution E2/AS1 paragraph 1.1 of the New Zealand Building Code
- Direct fix of claddings is only appropriate for dwellings with a risk matrix from 0-6 as to NZBC E2 Paragraph 3.0.
- Up to maximum of High Wind Zone areas

### FRAMING:

- Fixings for INNOWOOD are required at 450mm centers
- Use of a flexible underlay or Rigid Wall Underlay compliant to E2/AS1 Table 21 is required.
- Fixings of INNOWOOD into timber with the proprietary timber screw and a minimum 35mm penetration into the timber.

## 5.2 TIMBER BATTENS

### SCOPE:

Timber battens may be used in the following conditions:

- Up to maximum Extra High Wind Zone
- Maximum 10m high buildings
- All corrosion zones

### Timber battens must adhere to the following specifications:

- SG6 No. 1 Framing Grade or MSG6 as per NZS3604. The grading of timber must comply with NZS1748 and NZS3631 requirements.
- The external framing must be treated to a minimum H3.1 minimum. treatment as to NZS3640:2003.

- Compliant to NZS 3602:2003 part 1
- Min section for horizontally installed INNOWOOD cladding is 45x20 with castellated and beveled edge as to details provided: See section 6.
- Use of flexible underlay per E2/AS1 Table 21. A rigid wall underlay may be required additionally.
- Fixings of timber battens into the structure by using typical details.
- Fixings of INNOWOOD into timber with the proprietary timber screw and a minimum 35mm penetration into the timber.

## 5.3 GALVANIZED STEEL FRAMING

### SCOPE:

- Up to max Extra High Wind Zone
- Max 25m high buildings
- Corrosion zones B and C as to NZS3604:2011. For corrosion zone D, please contact SPS Roofing and Building.

### Steel battens to the following specifications::

- Top hats must have a face width of no less than 50mm and a wall thickness of no less than 1.15mm.
- Total depth of top hat plus packing and any non compressible thermal break tape (if using) must be minimum 35mm for walls and 15mm for softs. Note: Thermal break must be non compressible.
- Top hats must be set at max 450mm centers for external cladding or 600mm for internal cladding.
- Top hats must be fixed to structure at the required centers as per the table below and must always be fixed through both legs at all fixing points.
- Use of a flexible underlay or Rigid Wall Underlay compliant to E2/AS1 Table 21 is required.



- Top hats must be located expressly at the start and finish of each board run to enable the 1st and last screws in each board to be located 15-25mm in from end of cladding.
- The external framing must be 1.2BMT minimum with steel G500 and coating Z275, and comply to NZS1397:2011 and NZS4600:2005.
- Fixings of INNWOOD onto the steel profiles with wafer head into timber with the proprietary timber screw and a minimum 35mm penetration into the timber.

## 5.4 ALUMINIUM FRAMING

Under development - Please contact The Building Agency.

For use of INNWOOD outside the published scope, the architect, designer or engineer must undertake specific design and contact The Building Agency.

## 6. DETAILS



WC13625

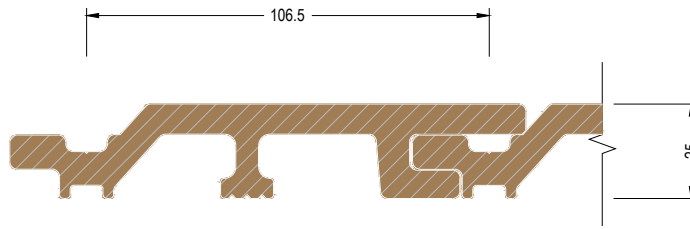

WC20025

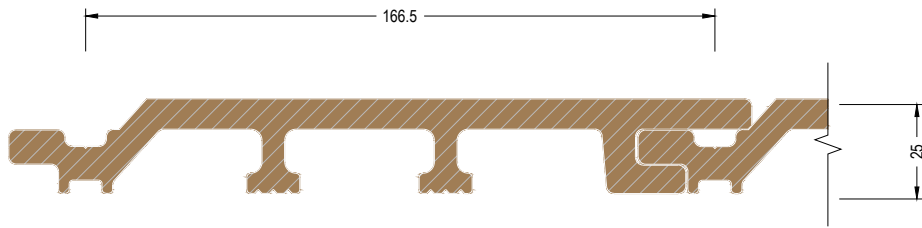

WC24025

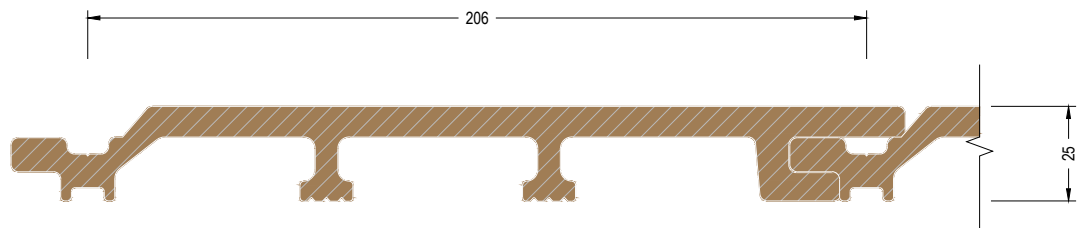

**CLADDING  
SCHEDULE**

Detail Number

IC-H20-A01

Version

[v1.3]

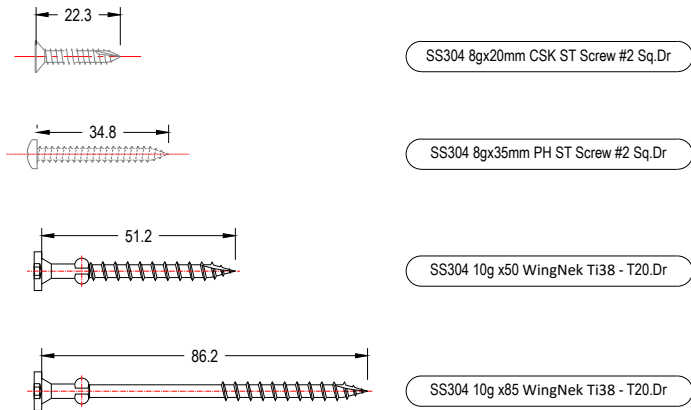
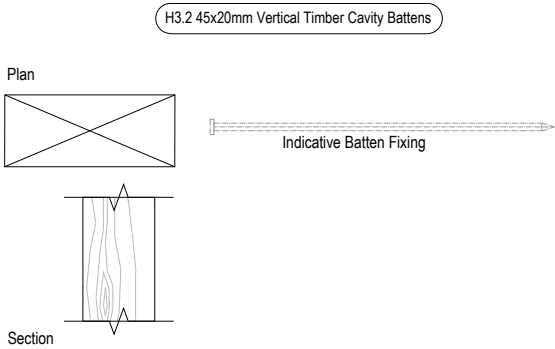

25 INN-REG Regular J mould

25 INN-PUN Drained J mould

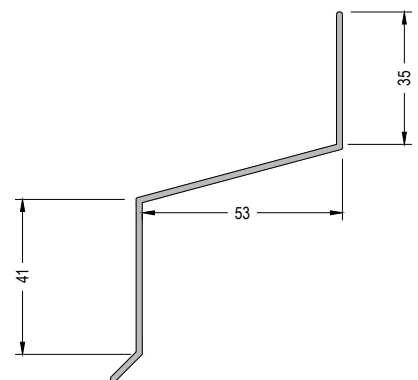
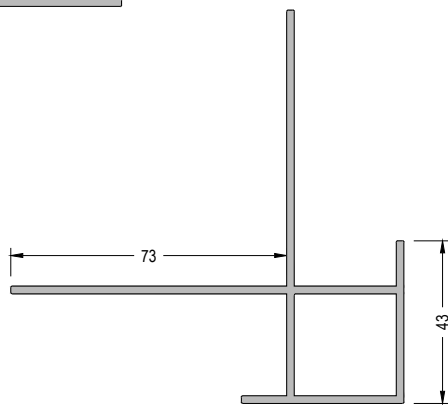
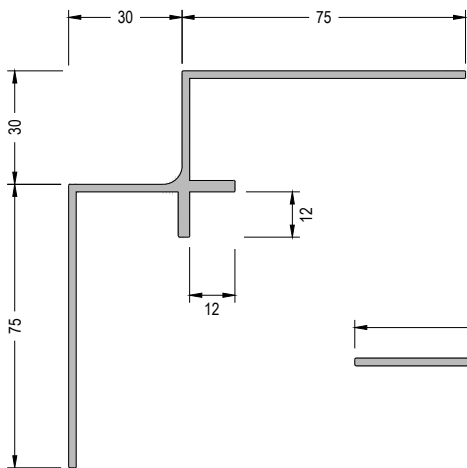
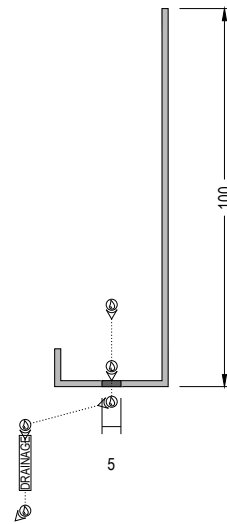
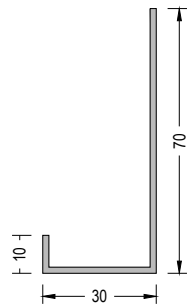

25 INN-INT Internal Corner

25 INN-EXT External Corner

25 INN-INT Interstory Flashing

## ACCESSORY SCHEDULE

Detail Number

IC-H20-A02

Version

[v1.3]



MATERIALS • SYSTEMS • SOLUTIONS

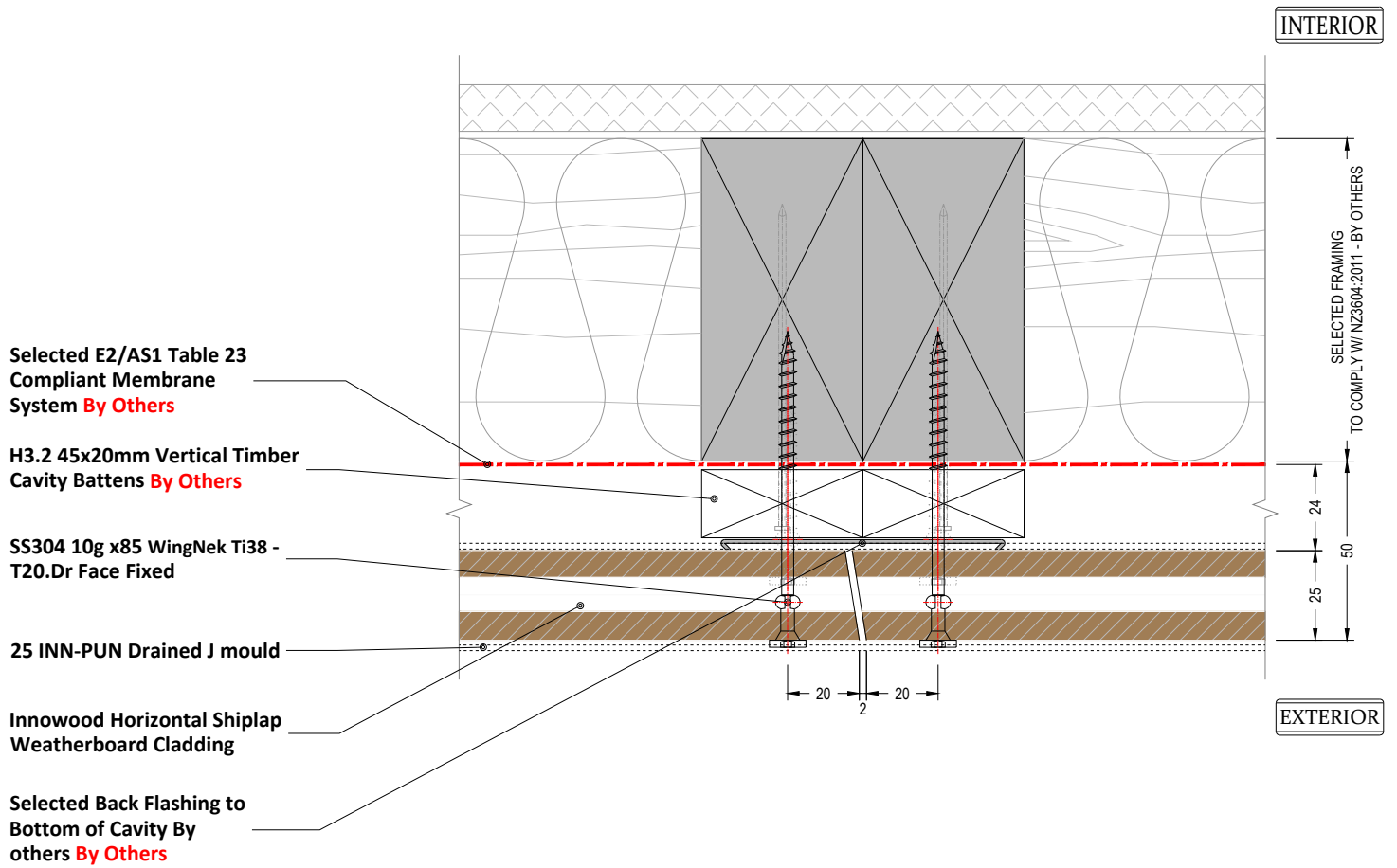

**VERTICAL  
JOINT**

Detail Number

IC-H20-001

Version

[v1.3]

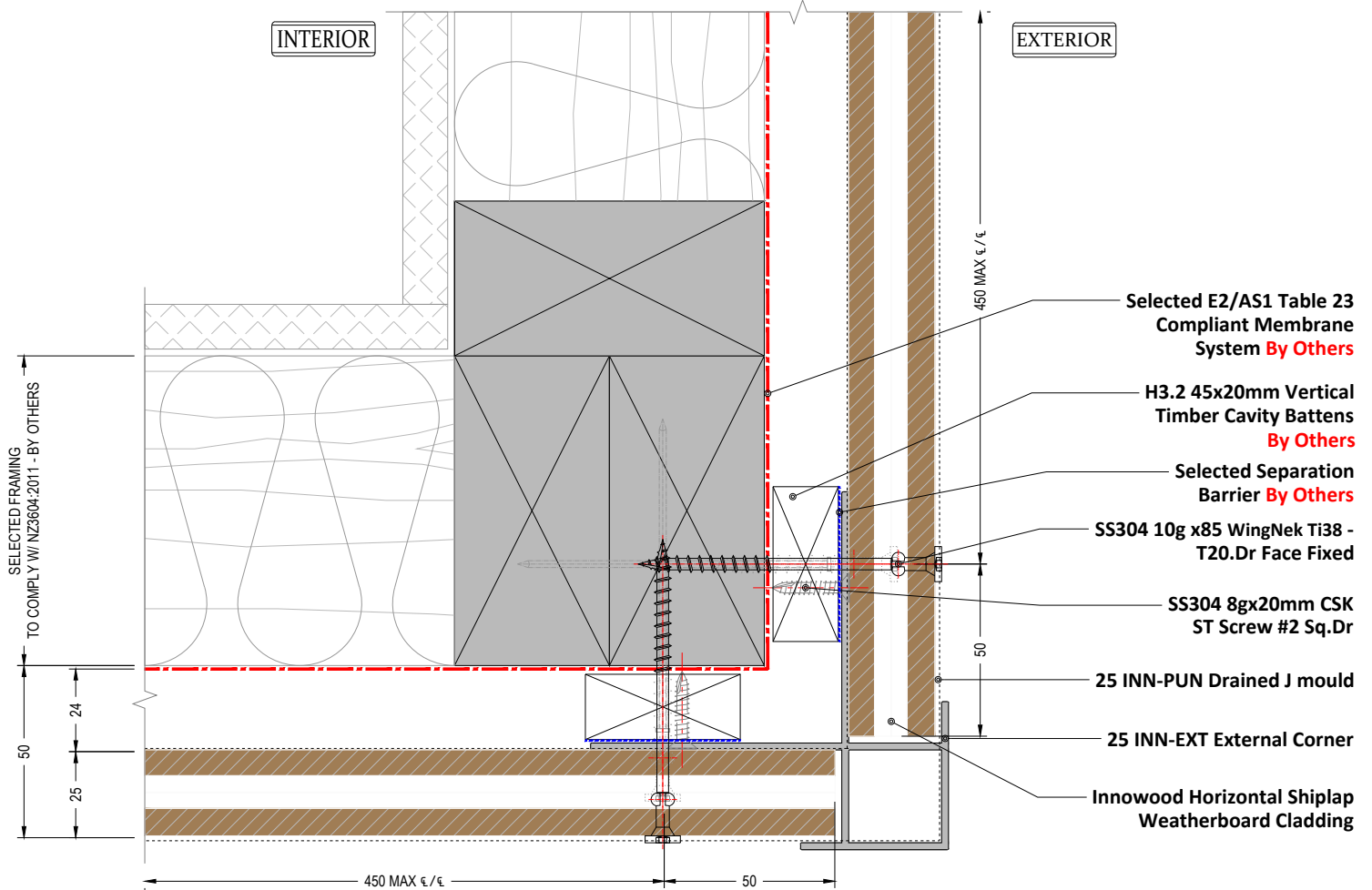

**NOTE**  
Selected Separation Barrier on Timber Batten is only needed on sites with Exposure Zone D

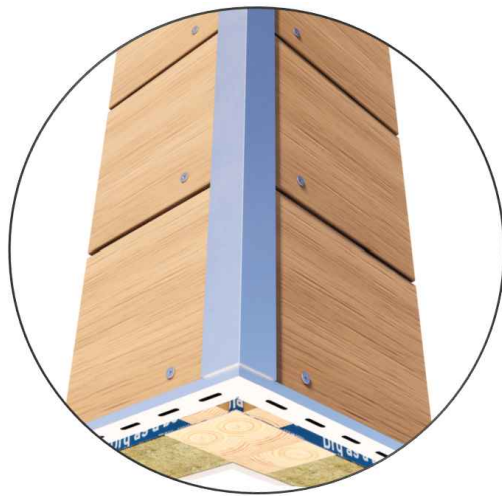

**EXTERNAL  
CORNER**

Detail Number  
IC-H20-002

Version  
[v1.3]

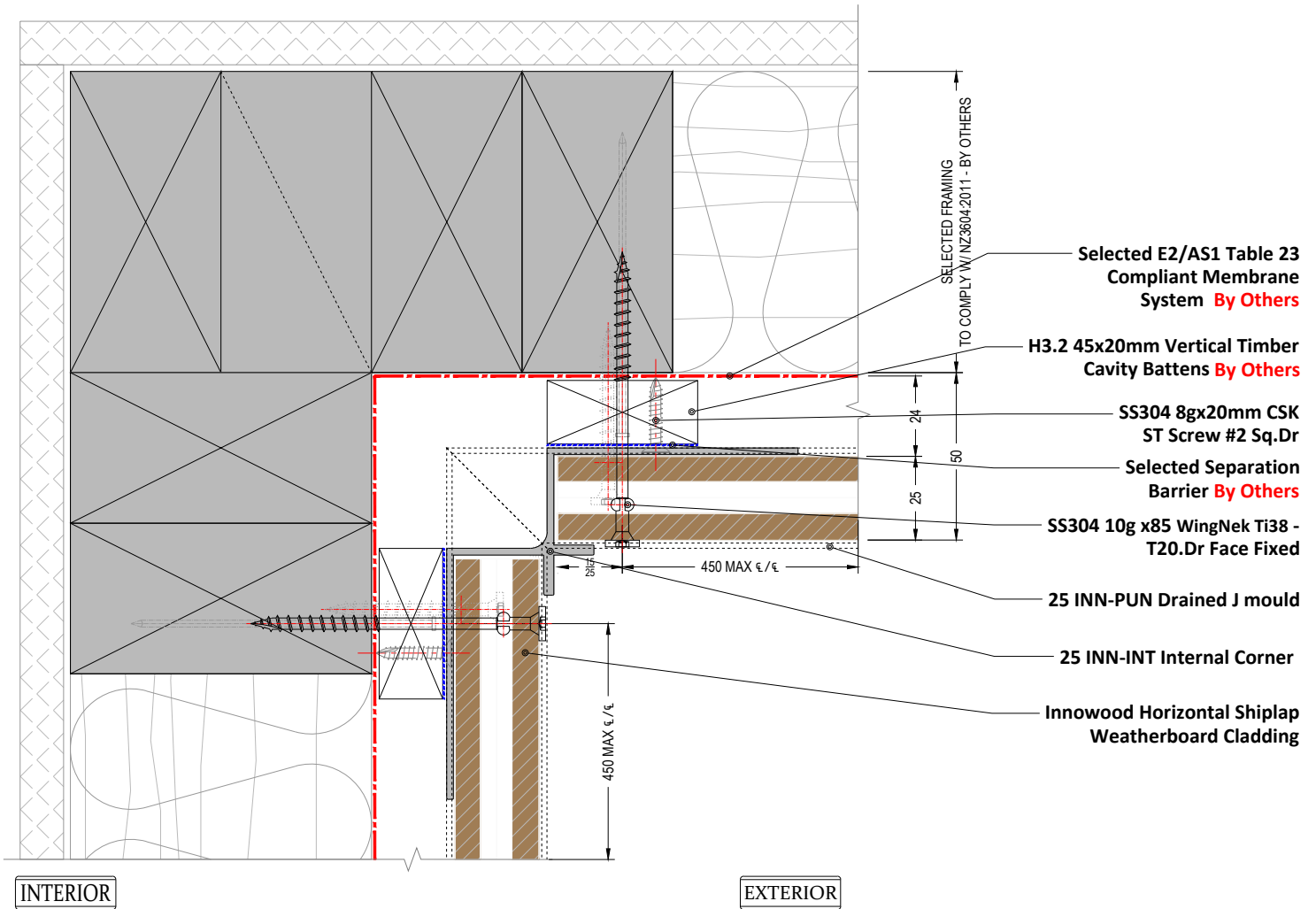

**NOTE**  
Selected Separation Barrier on Timber Batten is only needed on sites with Exposure Zone D

**INTERNAL  
CORNER**

Detail Number \_\_\_\_\_  
Version \_\_\_\_\_  
[v1.3]

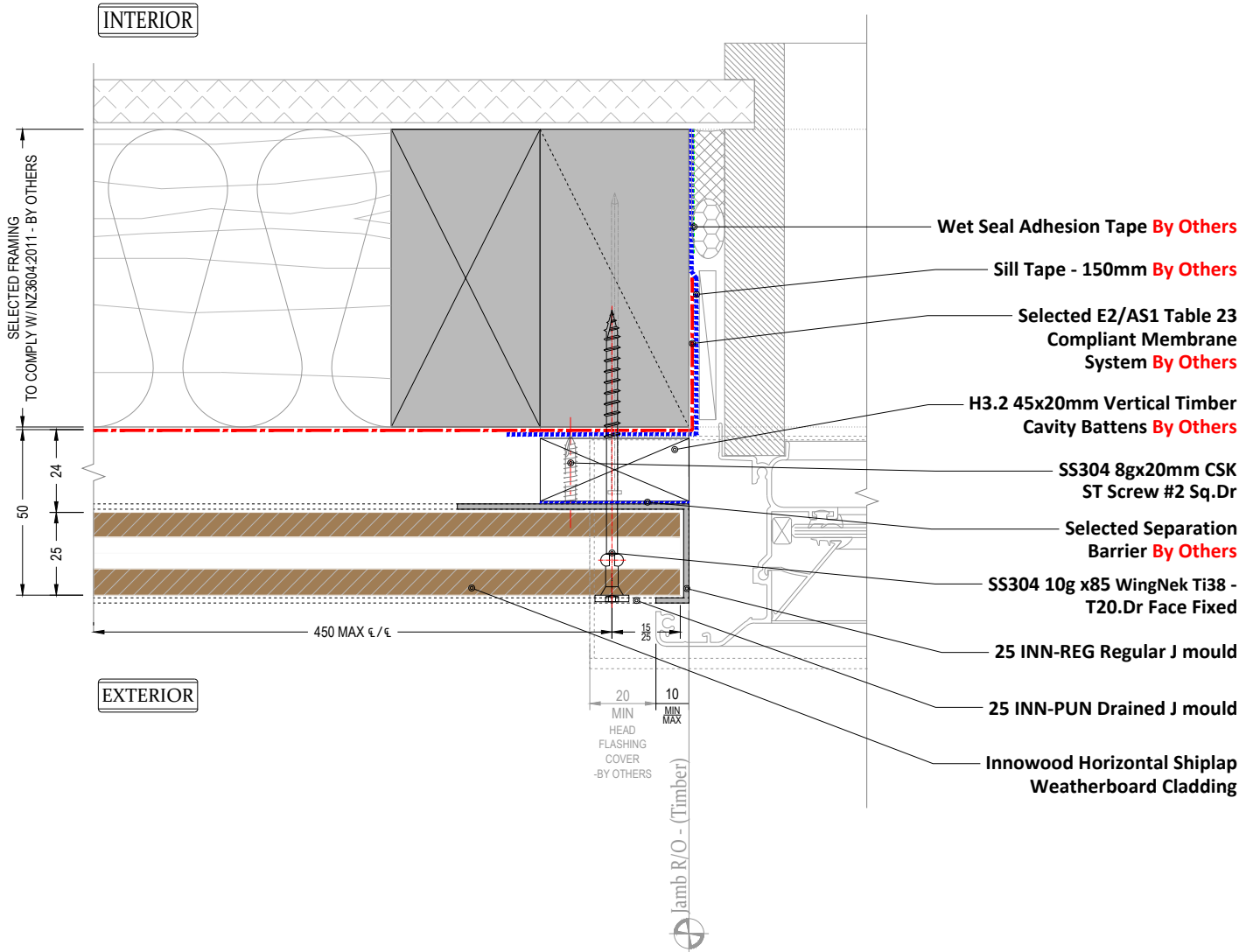

**NOTE**  
Careful consideration to window placement must be made in relation to cladding face to achieve minimal gap.  
Seal gaps of 5mm or greater W/ Suitable & Approved Sealant  
Selected Separation Barrier on Timber Batten is only needed on sites with Exposure Zone D



**WINDOW  
JAMB**

Detail Number  
IC-H20-004  
Version

[v1.3]



**MATERIALS • SYSTEMS • SOLUTIONS**



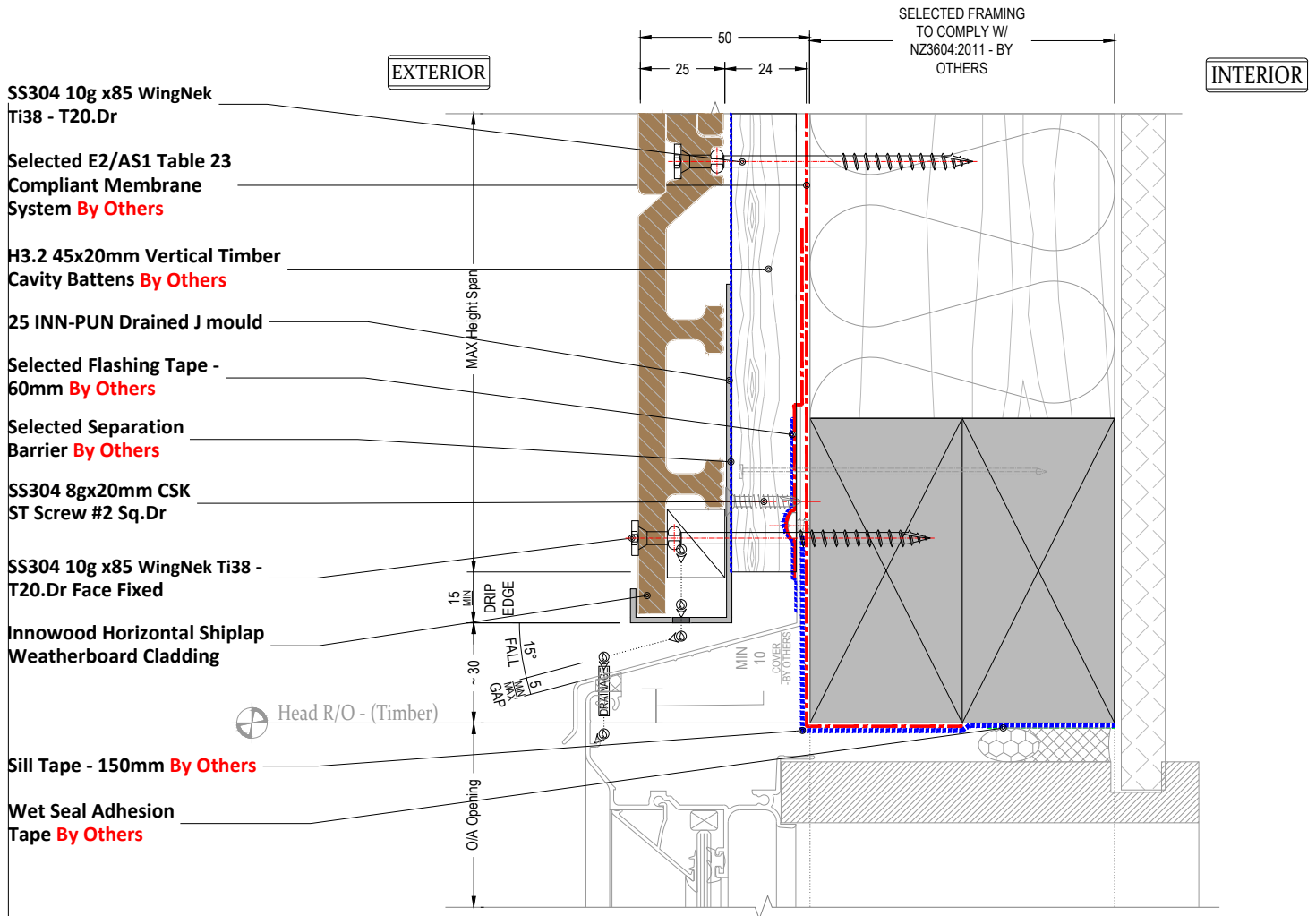

**NOTE**  
Careful consideration to window placement must be made in relation to cladding face to achieve minimal gap.  
Seal gaps of 5mm or greater w/ Suitable & Approved Sealant  
Selected Separation Barrier on Timber Batten is only needed on sites with Exposure Zone D

**WINDOW  
HEAD**

Detail Number

IC-H20-005

Version

[v1.3]

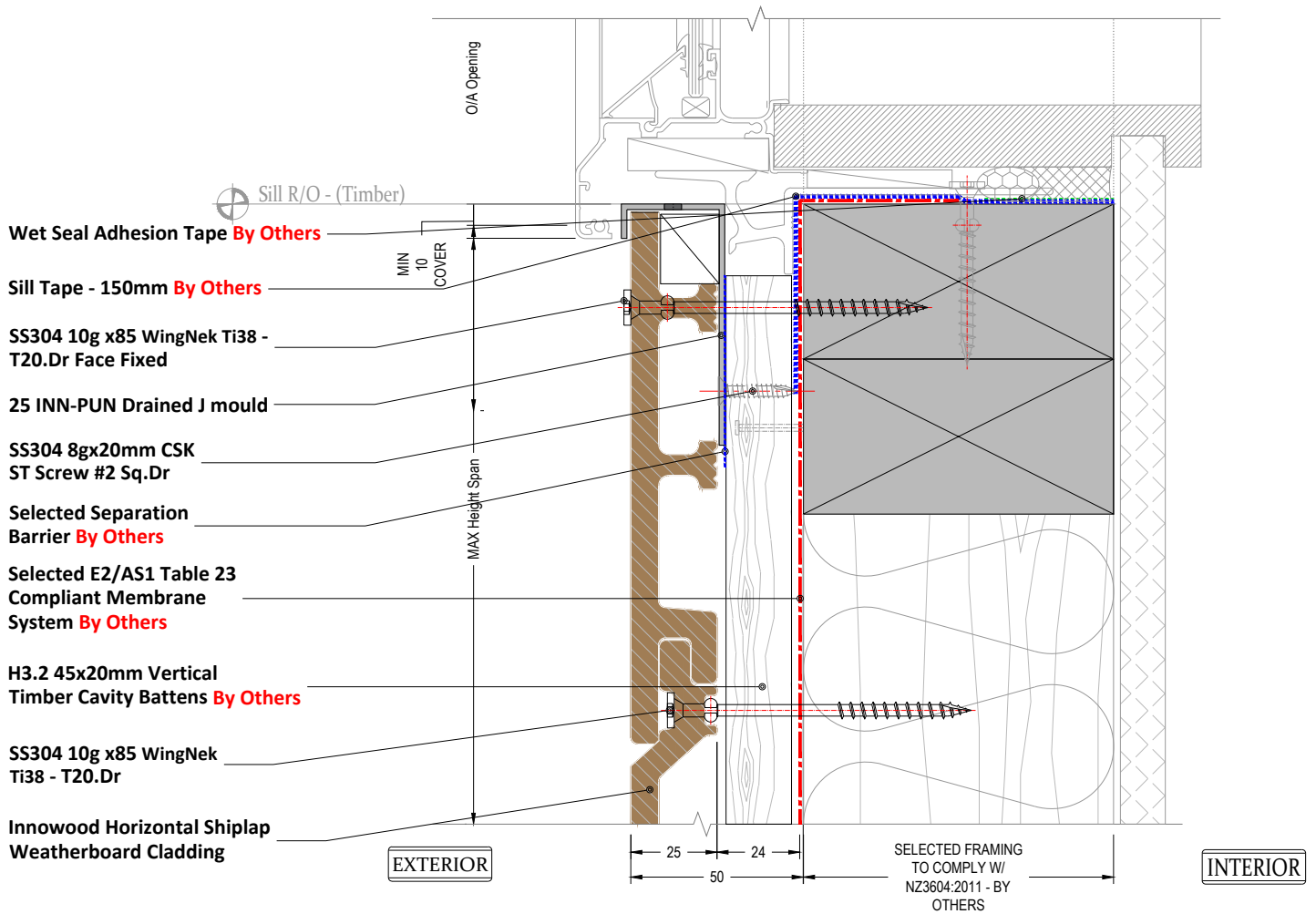

**NOTE**  
Careful consideration to window placement must be made in relation to cladding face to achieve minimal gap.  
Seal gaps of 5mm or greater W/ Suitable & Approved Sealant  
Selected Separation Barrier on Timber Batten is only needed on sites with Exposure Zone D

**WINDOW  
SILL**

Detail Number

IC-H20-006

Version

[v1.3]

**THE  
BUILDING  
AGENCY**

**MATERIALS • SYSTEMS • SOLUTIONS**

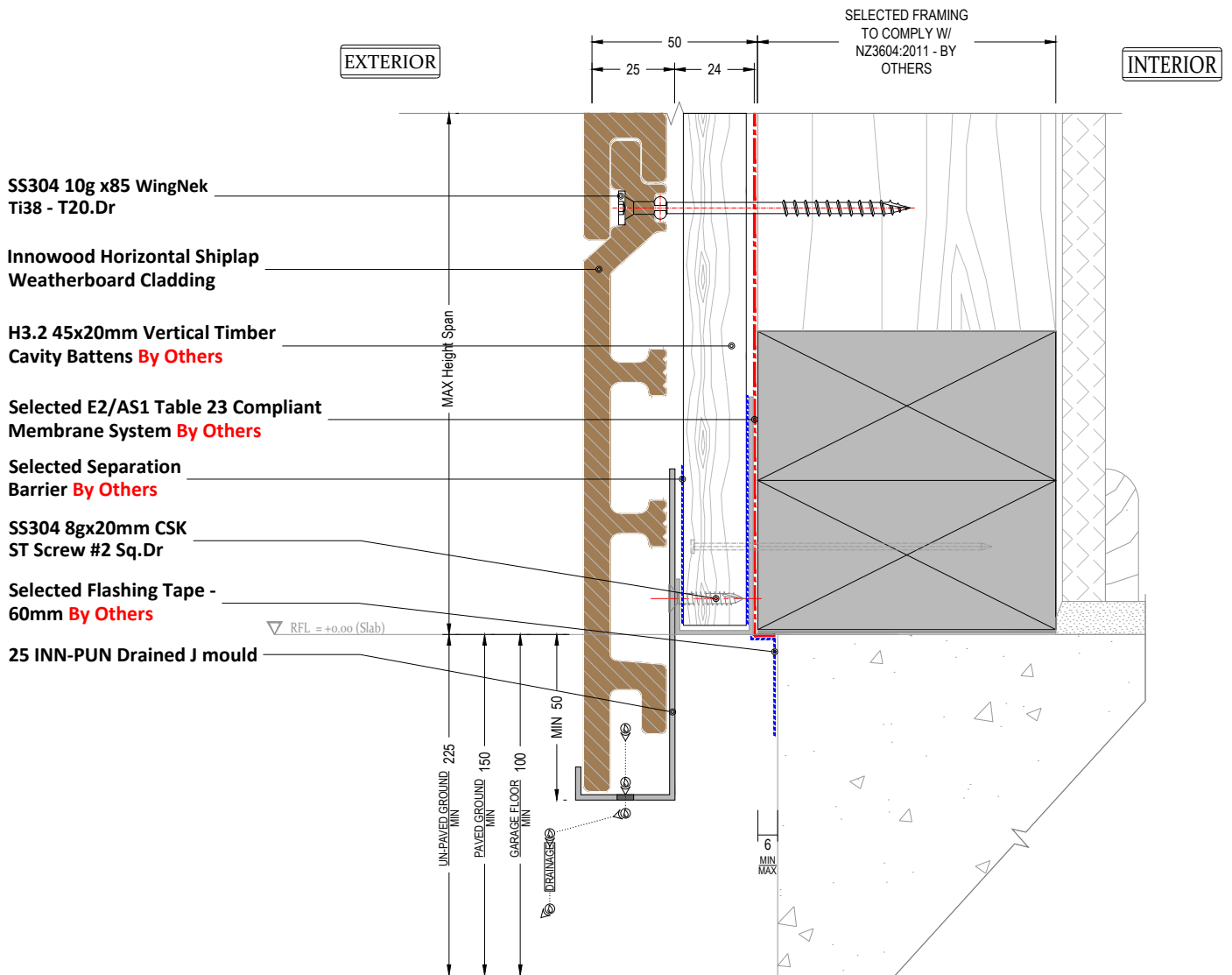

**NOTE**  
Selected Separation Barrier on Timber Batten is only needed on sites with Exposure Zone D

**FUNDATION  
TERMINATION**

Detail Number \_\_\_\_\_

IC-H20-007

Version \_\_\_\_\_

[v1.3]



**MATERIALS • SYSTEMS • SOLUTIONS**

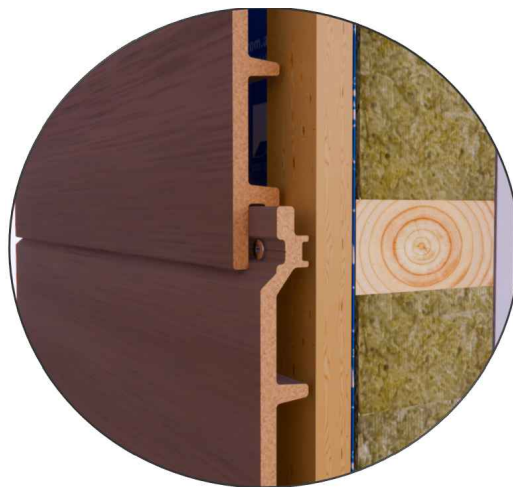
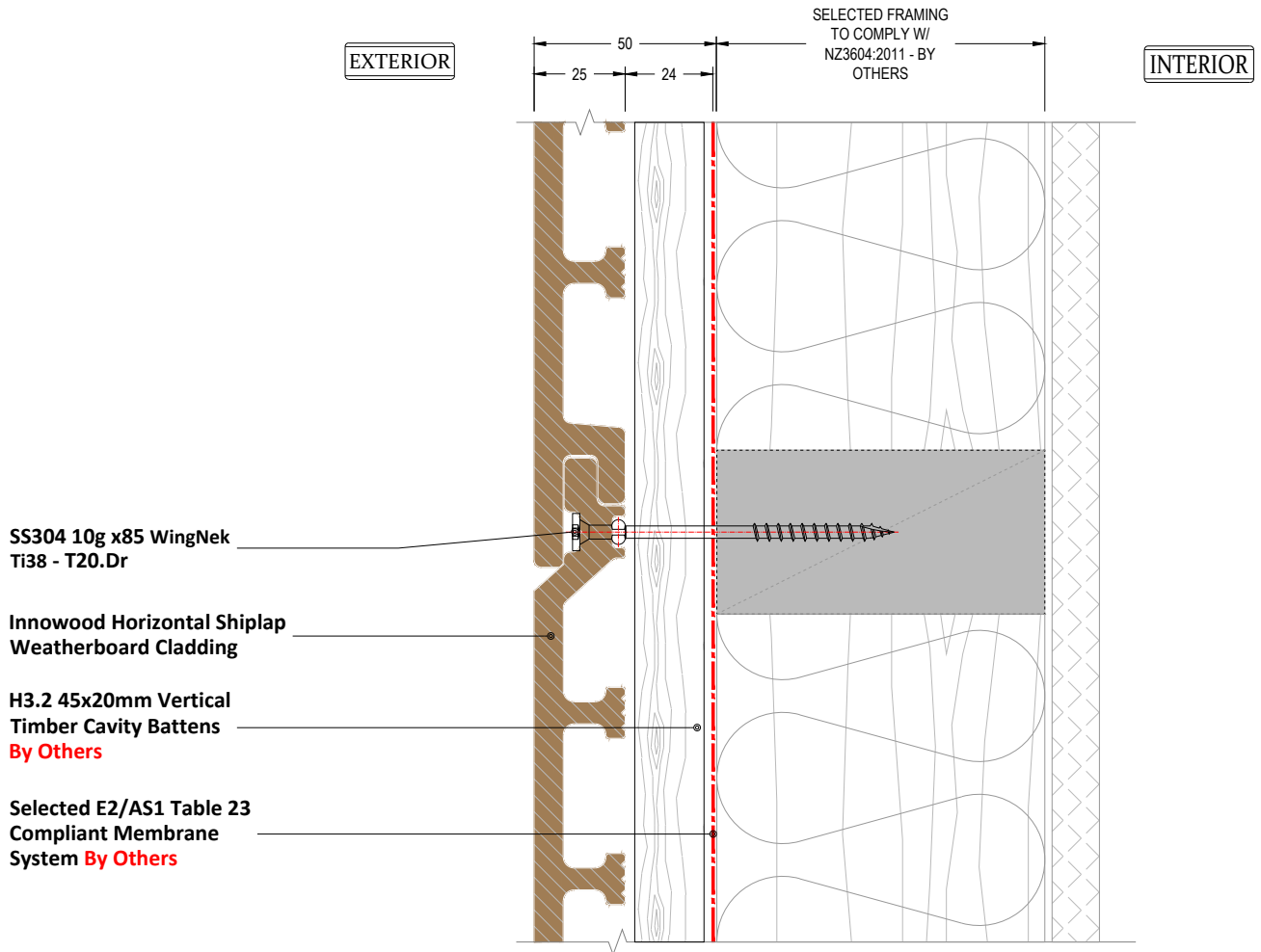

**HORIZONTAL  
JOINT**

Detail Number

IC-H20-008

Version

[v1.3]

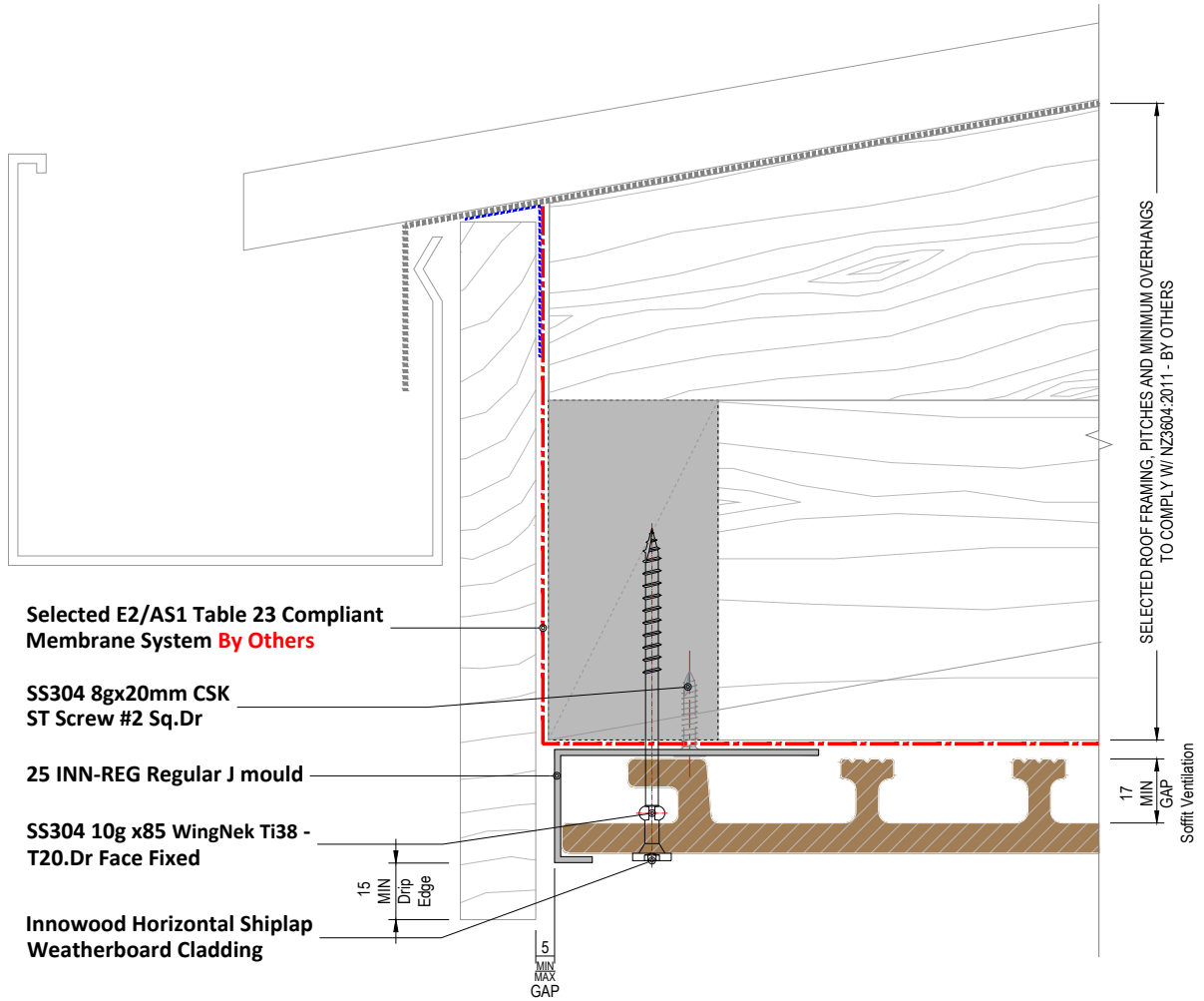

**NOTE**  
Weathering Membrane under a soffit is not required, but is recommendable for air barrier performance when a rigid wind barrier is not in use

**FASCIA TO  
SOFFIT / EAVE**

Detail Number \_\_\_\_\_

IC-H20-009

Version \_\_\_\_\_

[v1.3]



**MATERIALS • SYSTEMS • SOLUTIONS**

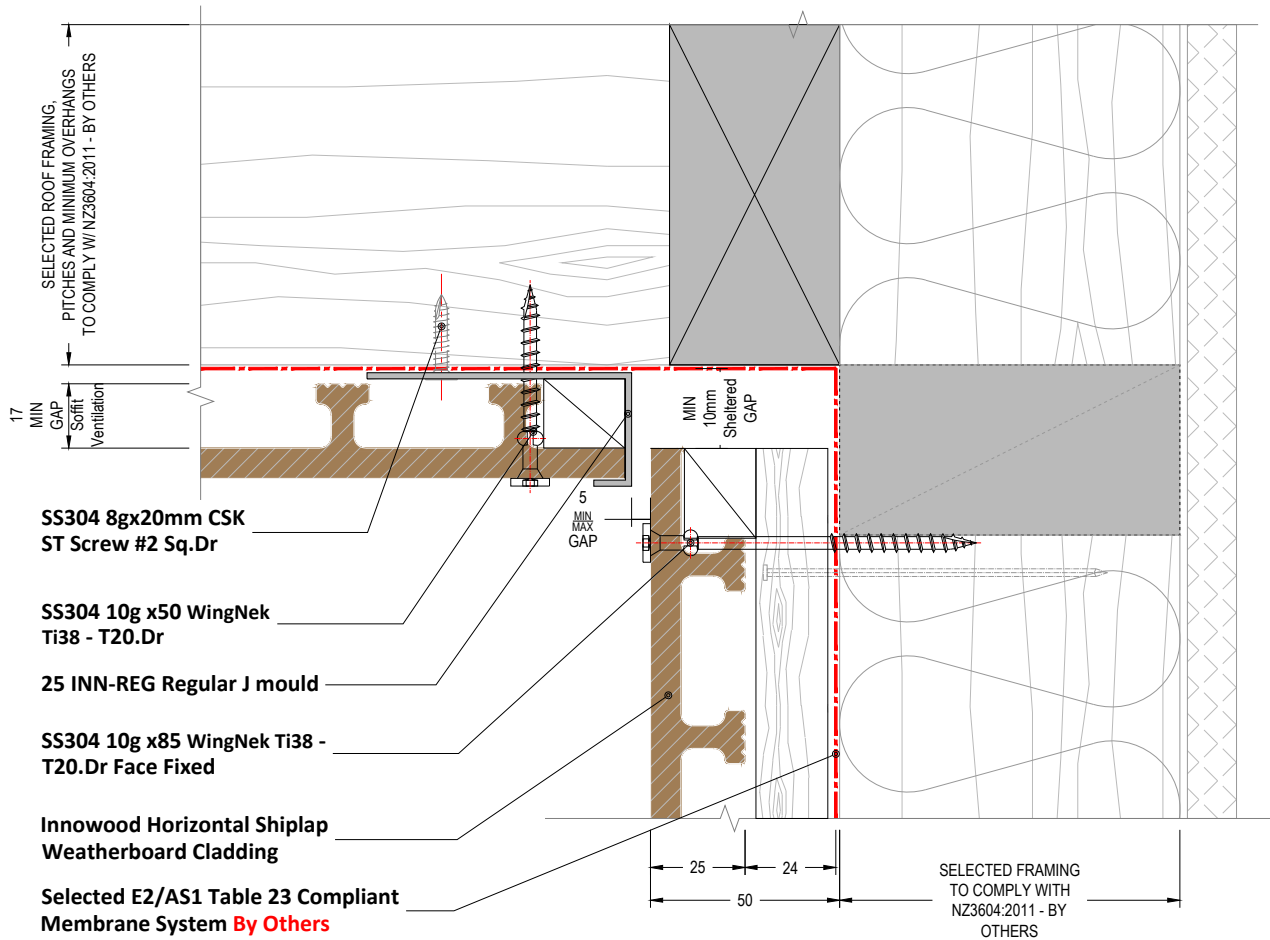

**NOTE**

Weathering Membrane under a soffit is not required, but is recommendable for air barrier performance when a rigid wind barrier is not in use

**SOFFIT / EAVE  
TO WALL**

Detail Number \_\_\_\_\_

IC-H20-010

Version \_\_\_\_\_

[v1.3]



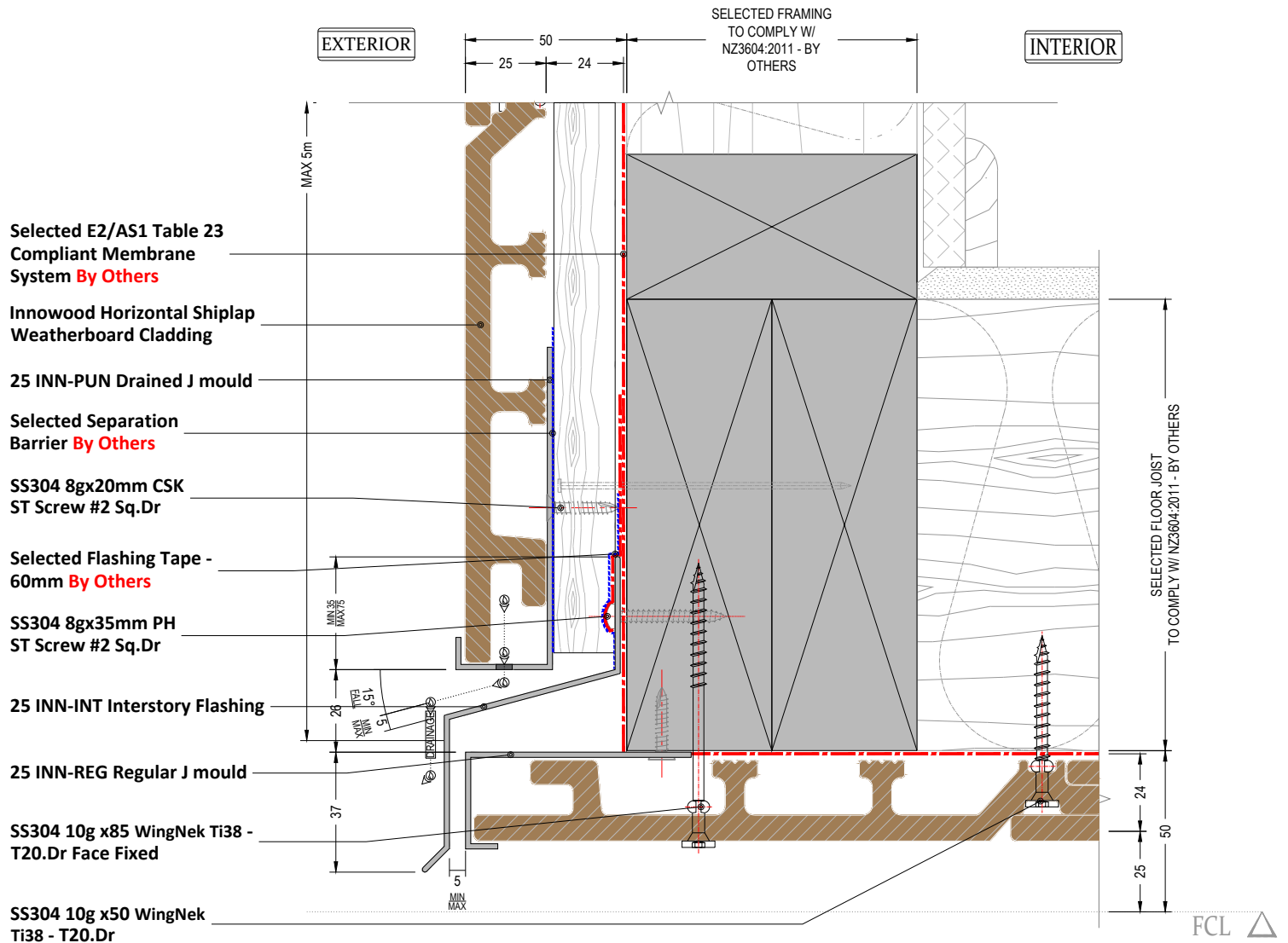

**NOTE**  
Selected Separation Barrier on Timber Batten is only needed on sites with Exposure Zone D

**WALL TO  
SOFFIT**

Detail Number

IC-H20-011

Version

[v1.3]



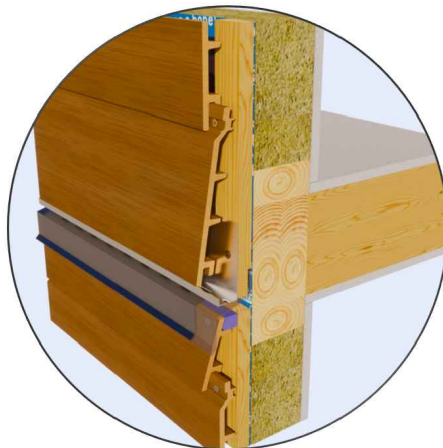
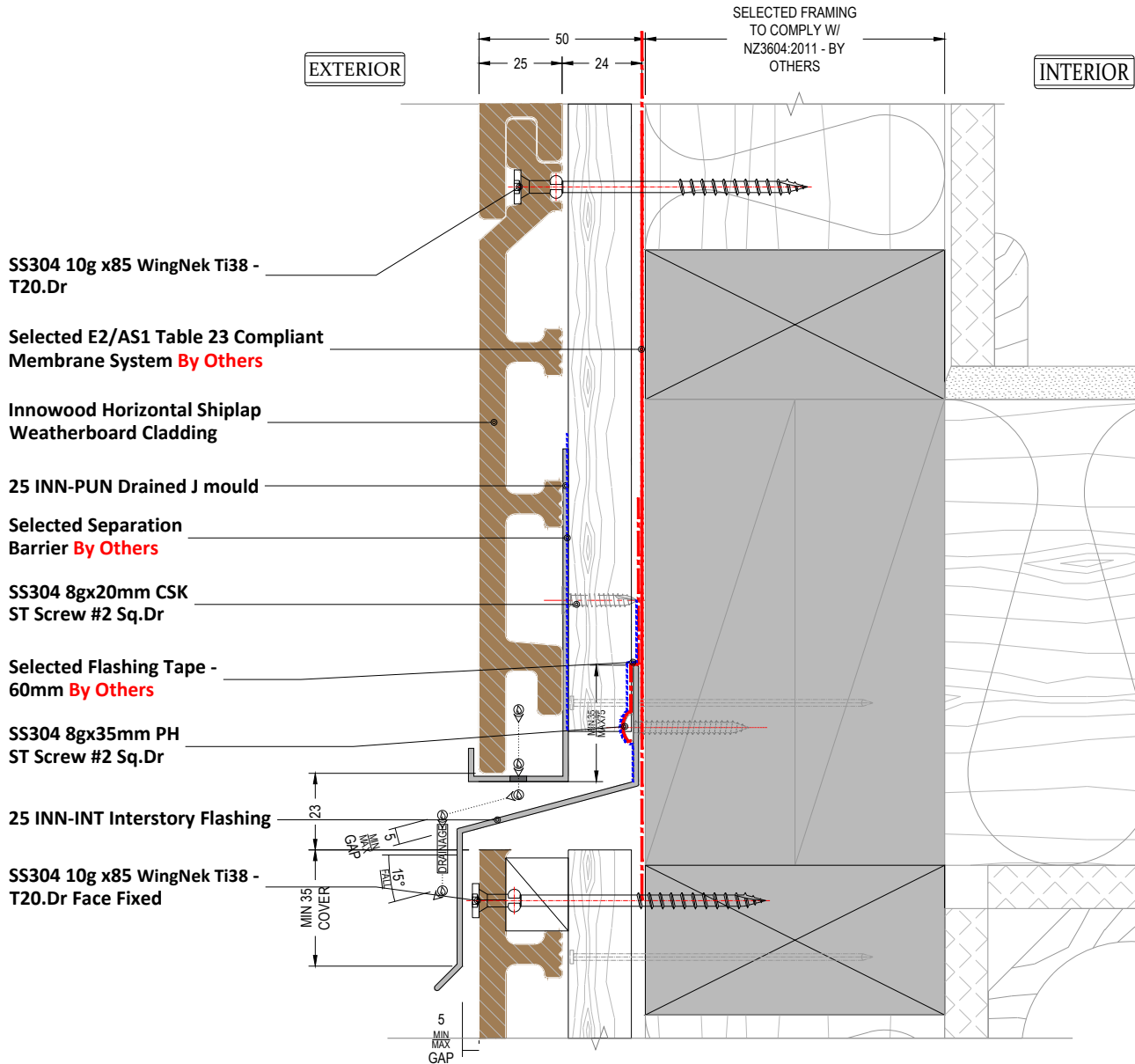

**NOTE**  
Selected Separation Barrier on Timber Batten is only needed on sites with Exposure Zone D

**INTER-STOREY  
JUNCTION**

Detail Number \_\_\_\_\_

IC-H20-012

Version \_\_\_\_\_

[v1.3]



**MATERIALS • SYSTEMS • SOLUTIONS**



NZBC - Acceptable Solution E2/AS1:(2011)

Table 7 : Z Values for Parapet Capping Cover Selection

- Situation 1: Low, Medium, High wind zones, where roof pitch  $\geq 10^\circ$  (X or Z values)
- Situation 2: All roof pitches in Very High wind zones, Low, Medium and High wind zones where roof pitch  $\leq 10^\circ$ . (X or Z values)
- Situation 3: For all roof pitches in Extra High wind zone

5° Fall

Selected Parapet Capping  
Flashing **By Others**

Selected E2/AS1 Table 23 Compliant  
Membrane System **By Others**

Innowood Horizontal Shiplap  
Weatherboard Cladding

SS304 10g x85 WingNek Ti38 -  
T20.Dr

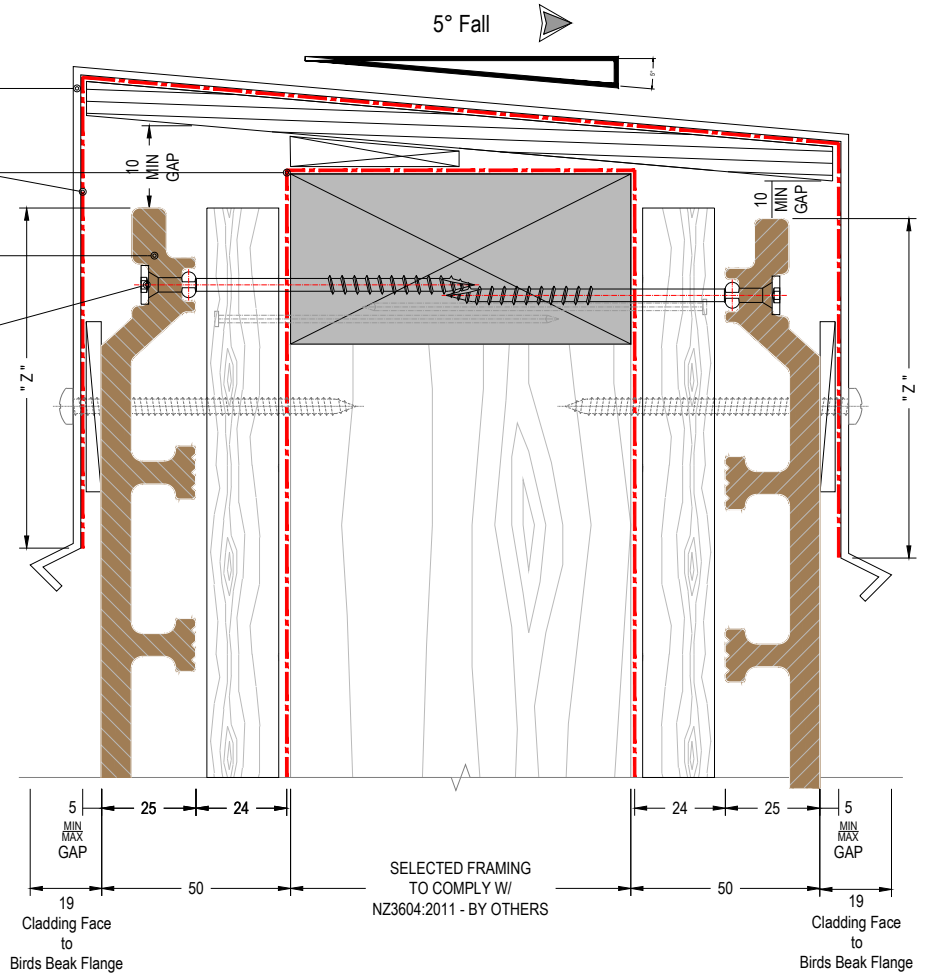
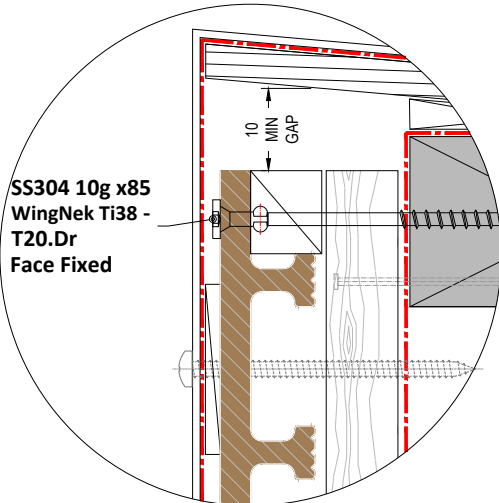

Alternative When board is cut



## PARAPET CAPPING

Detail Number

IC-H20-013

Version

[v1.3]

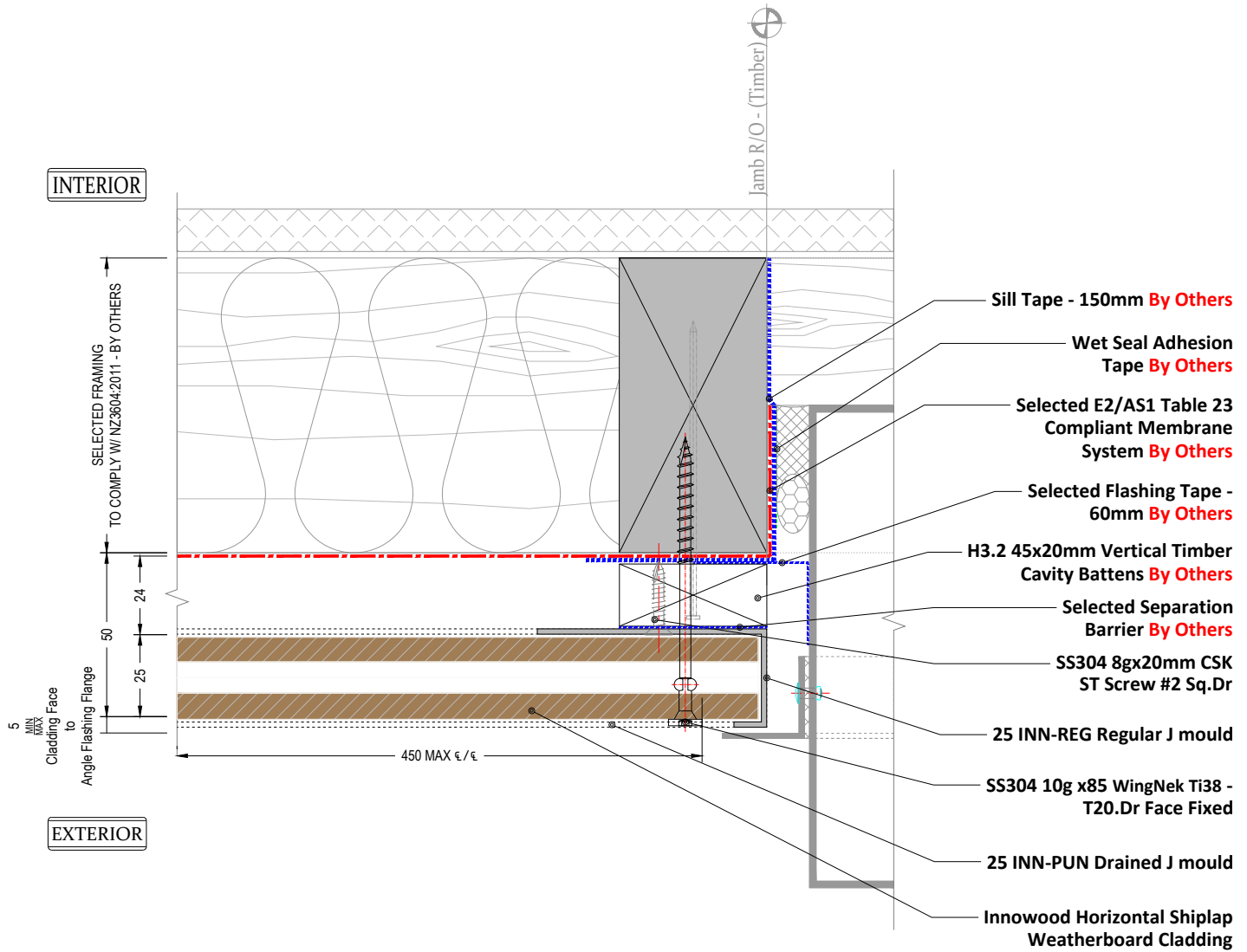

**NOTE**  
Careful consideration to meterbox placement must be made in relation to cladding face to achieve minimal gap.  
..Flashing Angle Bedsealed + Riveted  
Seal gaps of 5mm or greater W/ Suitable & Approved Sealant  
Selected Separation Barrier on Timber Batten is only needed on sites with Exposure Zone D

**METERBOX  
JAMB**

Detail Number

IC-H20-014

Version

[v1.3]

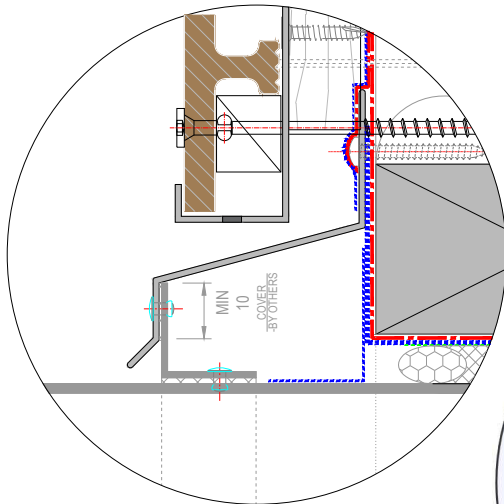
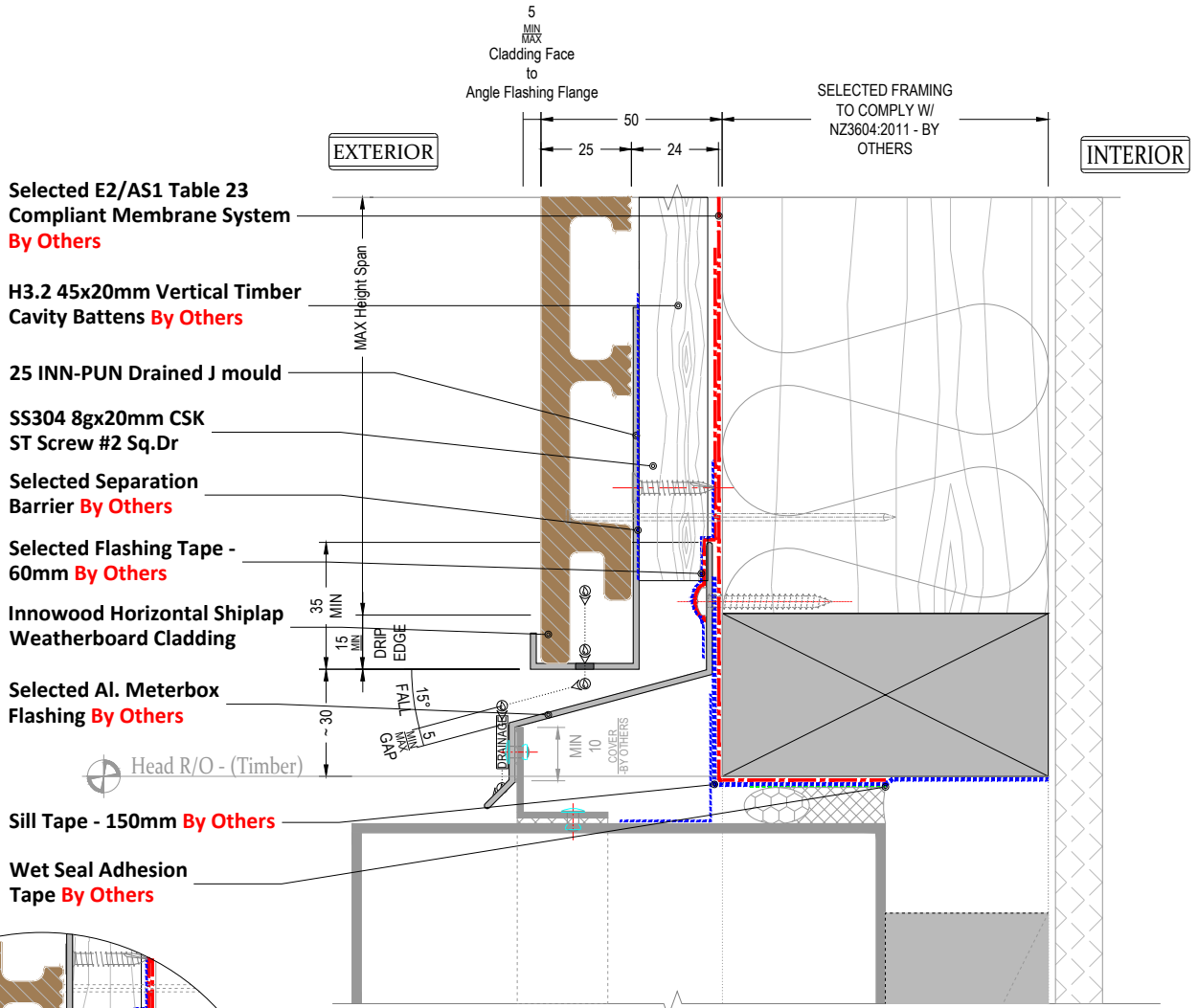

Alternative When board is cut



**NOTE**  
Careful consideration to meterbox placement must be made in relation to cladding face to achieve minimal gap.  
..Flashing Angle Bedsealed + Riveted  
Seal gaps of 5mm or greater W/ Suitable & Approved Sealant  
Selected Separation Barrier on Timber Batten is only needed on sites with Exposure Zone D

**METERBOX  
HEAD**

Detail Number \_\_\_\_\_

IC-H20-015

Version \_\_\_\_\_

[v1.3]

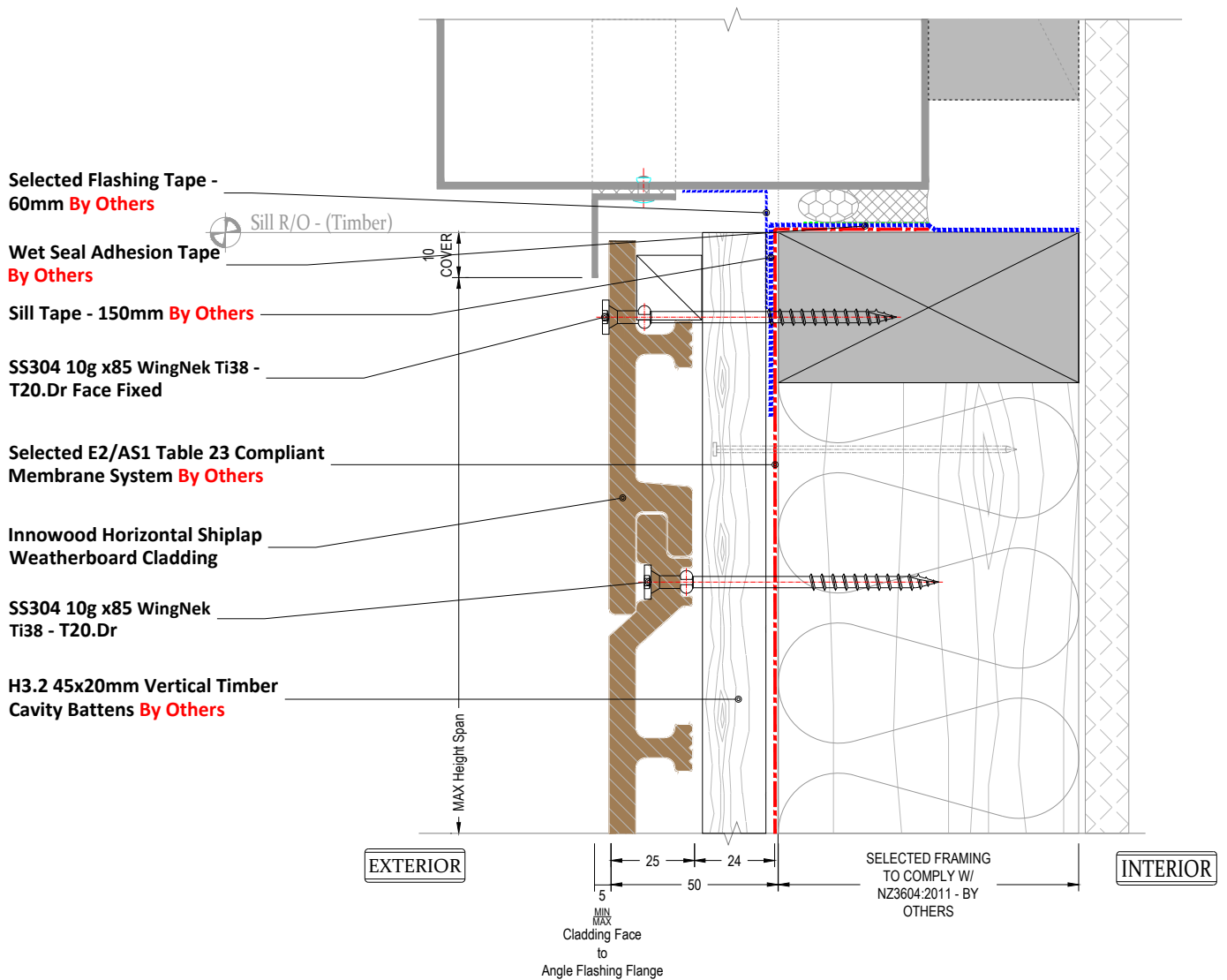

**NOTE**  
Careful consideration to meterbox placement must be made in relation to cladding face to achieve minimal gap.  
∴ Flashing Angle Bedsealed + Riveted  
Seal gaps of 5mm or greater W/ Suitable & Approved Sealant

**METERBOX  
SILL**

Detail Number  
IC-H20-016

Version  
[v1.3]



**MATERIALS • SYSTEMS • SOLUTIONS**

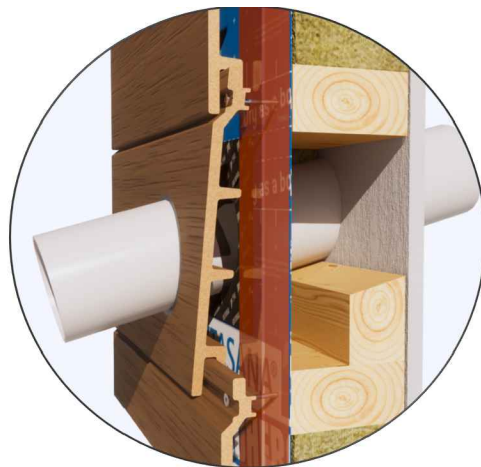
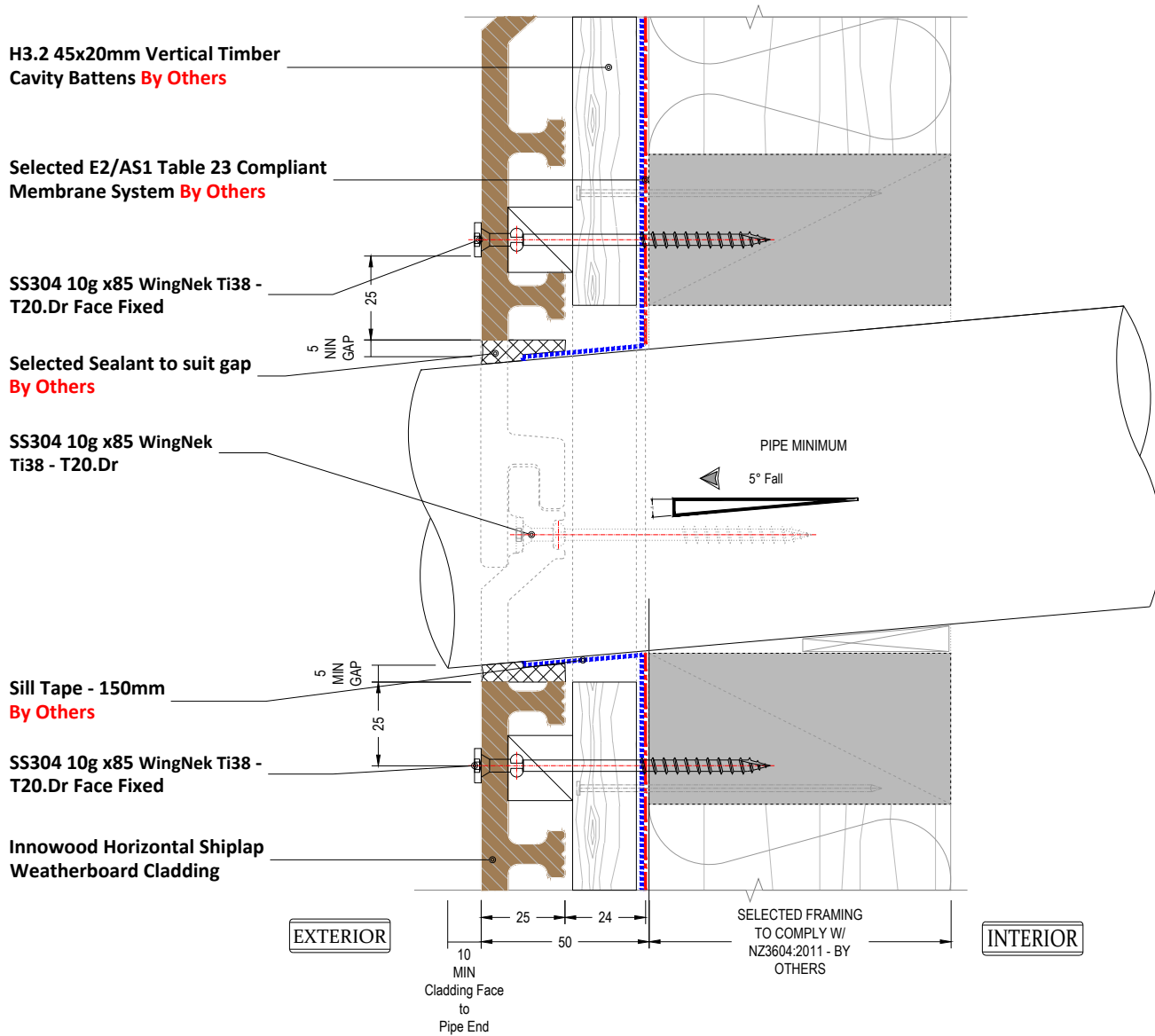

**PIPE (CIRCULAR)  
PENETRATION**

Detail Number \_\_\_\_\_

IC-H20-017

Version \_\_\_\_\_

[v1.3]

