

Push and Pull Door Furniture

Push and Pull Door Furniture

184 Offset Pull

Made from brass and designed to compliment 1800 and 2800 Series Brass Plate Furniture, the 184 Offset Pull provides a fixed pull without impacting the cylinder/turn functionality or the design aesthetic of a plate furniture installation.

Application

Designed for use with Lockwood 3570 Synergy and 3P70 Pentagon Series Mortice Locks using Lockwood 1800 or 2800 Series Brass Plate Furniture.

Recommended for Access Control doors with electric strikes.

Compliance

 **DISABLED ACCESS – AS1428.1** ✓

Dimensions

| | |
|-------------------|---------|
| Length: | 163.5mm |
| Diameter: | 16mm |
| Projection: | 61mm |
| Screw Centres: | 147.5mm |
| Finger Clearance: | 45mm |

Fixing

The 184 Pull is designed with 147.5mm screw centres to enable it to be fixed through a standard visible fix brass plate (1900 or 2900).

Plates are to be ordered separately to the 184 and care should be taken to ensure that a visible fix plate is specified for both sides of the door.

Finishes

| | |
|----------------------|----|
| Satin Chrome Brushed | SC |
| Chrome Plate | CP |

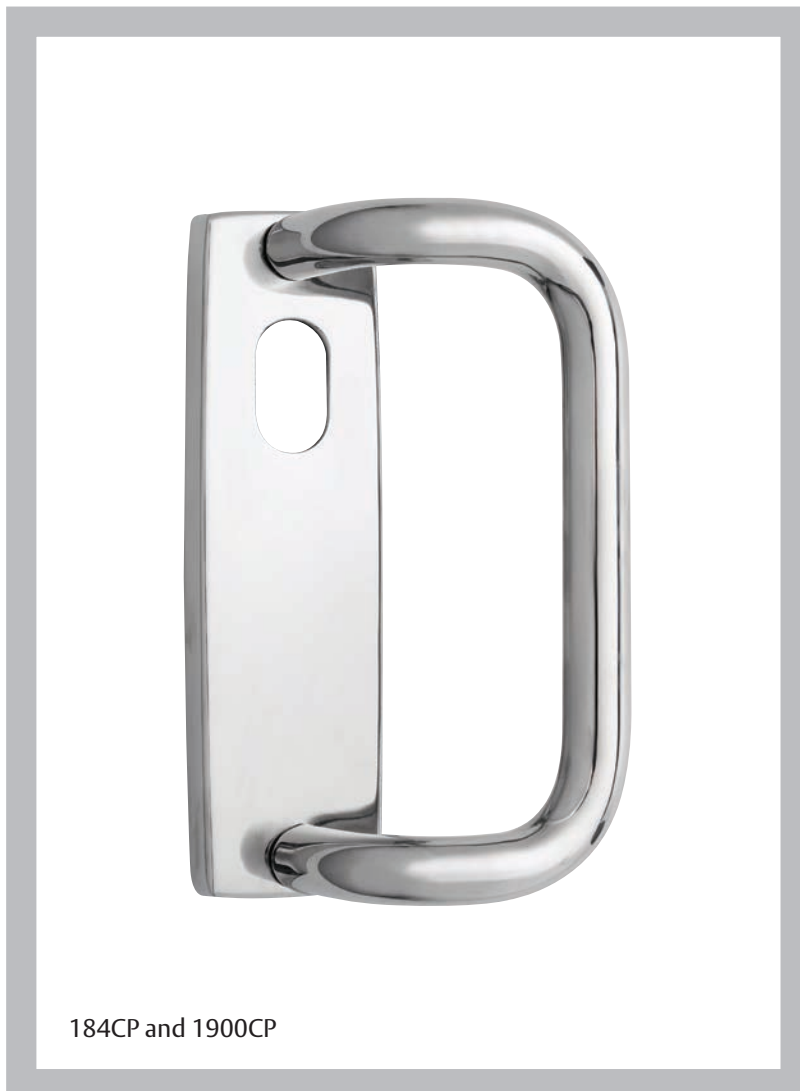

Push and Pull Door Furniture

194 Series Round End Push and Pull Plates

Made from brass and supplied completely assembled with handles if applicable. "PUSH" or "PULL" plates are engraved with 16mm high letters.

Application

Brass Push and Pull Handle Door Furniture for public, commercial and industrial buildings.

Compliance

 **DISABLED ACCESS – AS1428.1** ✓

Dimensions

Length: 255mm
 Width: 52mm
 Thickness: 10mm
 Diameter: 17.5mm
 Finger Clearance: 43mm

Fixing

Plates are designed to fit back to back. The external plate is supplied with concealed fixings and therefore must be used with an internal plate which has visible fixings.

Finishes

The 194 Series is only available in the following finishes:

| | |
|----------------------|----|
| Chrome Plate | CP |
| Polished Brass | PB |
| Satin Chrome Brushed | SC |

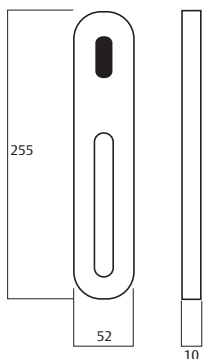

Plate Options for 194 Pull Plate with 'P2' Pulls

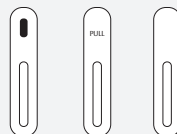
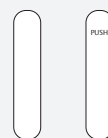



Plate Options for 194 Pull Plate with 'P3' Pulls



Plate Options for 194 Push Plate



Plates and Functions Legend

Cylinder Hole 

Push and Pull Door Furniture

194 Series Ordering Procedure

Ordering Procedure

Sample part number 19424N/P2SC is made up of several sections. Choose your product by selecting an option from each section.

For example:

| | | | | |
|-------------------|-----------------------|------------------|--------------------|---------------|
| Plate Type | Plate Function | Engraving | Pull Handle | Finish |
| 194 | 24 | N | P2 | SC |

| Plate Type | Engraving | Finish |
|---|-----------------------------|-------------------------|
| Exterior Round End Push and Pull Plate (Concealed Fixing) 194 | No Option N | Chrome Plate CP |
| | Push Text Outlined Infill F | Satin Chrome Brushed SC |
| | Pull Text Outlined Infill G | Polished Brass PB |
| Interior Round End Push and Pull Plate (Visible Fixing) 195 | | |

| Plate Function | Pull Handle |
|-----------------------------|------------------------------------|
| Plain Plate 07 | None |
| Pull Handle Only 24 | 17.5mm diameter 152mm centre P2 |
| Pull Handle and Cylinder 25 | 17.5mm diameter 203mm centre P3 |

Push and Pull Door Furniture

206/207 Series Push and Pull Plates



ASSA ABLOY

Application

The 206/207 Series Door Furniture are 2mm thick stainless steel plates with 10mm radius corners. Concealed fixed plates have studs with internal threads located in each corner, visible plates have corresponding countersunk holes and are fixed back to back through the door.

Designed for use with Lockwood 3570 Synergy and 3P70 Pentagon Series Mortice Locks.

Compliance

DISABLED ACCESS – AS1428.1 ✓

Dimensions

| | |
|-------------------|--------|
| Length: | 250mm |
| Width: | 200mm |
| Thickness: | 2mm |
| Handle Diameter: | 17.5mm |
| Finger Clearance: | 40mm |

Materials

Stainless steel.

Door Thickness

35 to 45mm standard. For doors 45 to 55mm thick, specify long fixing screws SP2000-208.

Finishes

| | |
|--------------------------|----|
| Satin Stainless Steel | SS |
| Powdercoat | PC |
| Polished Stainless Steel | PS |



Plates

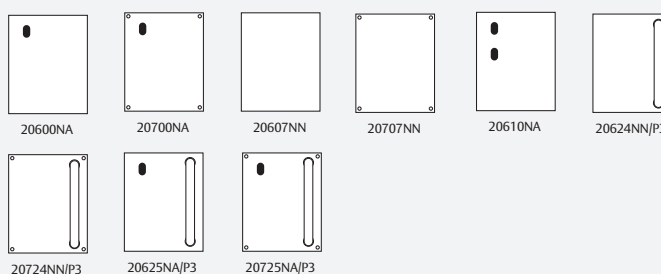

Legend

| | | | | | |
|---------------|--|----------------|--|---------------------------|--|
| Cylinder Hole | | Slotted Button | | LED | |
| Turn-Snib | | Disabled | | Indicating Slotted Button | |

D Handle Selections

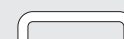

Brass or Stainless Steel 17.5mm

P3

Centres

203mm

Push and Pull Door Furniture

208/209 Series Push and Pull Plates

Application

The 208/209 Series Door Furniture are 2mm thick stainless steel or brass plates with 10mm radius corners. Concealed fixed plates have studs with internal threads located in each corner, visible plates have corresponding countersunk holes and are fixed back to back through the door.

Designed for use with Lockwood 3570 Synergy and 3P70 Pentagon Series Mortice Locks.

Compliance

 **DISABLED ACCESS – AS1428.1** ✓

Dimensions

Length: 324mm
 Width: 162mm
 Thickness: 2mm
 Handle Diameter: 17.5mm
 Finger Clearance: 40mm

Materials

Stainless steel.

Door Thickness

35 to 45mm standard. For doors 45 to 55mm thick, specify long fixing screws SP2000-208.

Finishes

Satin Stainless Steel SS
 Powdercoat PC
 Polished Stainless Steel PS



Plates

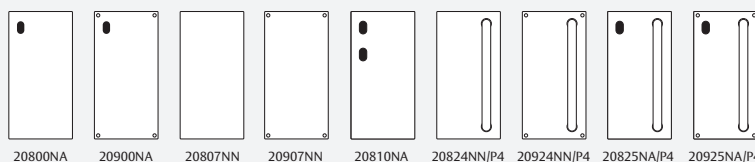

Legend

| | | | | | |
|---------------|---|----------------|---|---------------------------|---|
| Cylinder Hole |  | Slotted Button |  | LED |  |
| Turn-Snib |  | Disabled |  | Indicating Slotted Button |  |

D Handle Selections

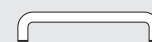

Brass or Stainless Steel 17.5mm

P4

Centres

250mm

Push and Pull Door Furniture

214/215 Series 10mm Radius Corner

Push and Pull Plates

Application

The 214 Series Door Furniture is 300 x 100 x 2mm thick stainless steel or brass plates with 10mm radius corners. Concealed fixed plates have studs with internal threads located in each corner, visible plates have corresponding countersunk holes and are fixed back to back through the door.

Designed for use with Lockwood 3570 Synergy and 3P70 Pentagon Series Mortice Locks.

Compliance

DISABLED ACCESS – AS1428.1 ✓

Dimensions

| | |
|-------------------|--------|
| Length: | 300mm |
| Width: | 100mm |
| Thickness: | 2mm |
| Handle Diameter: | 17.5mm |
| Finger Clearance: | 40mm |

Materials

Stainless steel or brass.

Door Thickness

35 to 45mm standard. For doors 45 to 55mm thick, specify long fixing screws SP2000-208.

Finishes

| | |
|--------------------------|----|
| Satin Stainless Steel | SS |
| Polished Stainless Steel | PS |
| Powdercoat | PC |
| Polished Brass | PB |

Function/Handle Selection

Certain functions require certain handles to be used. The following table outlines which length handles (screw centre distance shown) should be used for a given function.

| Function | Description | No Engraving | With Engraving |
|----------|--|--------------|----------------|
| 24 | Pull Handle Only | P4 | P3 |
| 25 | Pull Handle and Cylinder | P2 | P2 |
| 26 | Pull Handle and Emergency Turn | P2 | P2 |
| 27 | Pull Handle and Turn Knob | P2 | P2 |
| 28 | Pull Handle and Privacy Indicator Emergency Turn | P2 | P2 |
| 29 | Pull Handle and Privacy Indicator Turn Knob | P2 | P2 |
| 30 | Pull Handle and Dual Cylinder | × | × |
| 42 | Pull Handle and Disabled Turn | P2 | P1 |
| 44 | Pull Handle Only – Offset from Bottom | P1 P2 | × |

Note: x indicates this function is not available in this configuration.



Plates

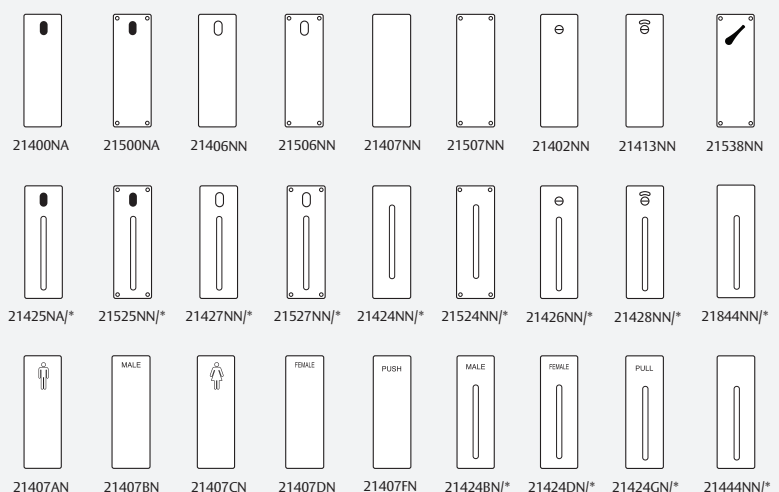

Legend

| | | | | | |
|---------------|--|----------------|--|---------------------------|--|
| Cylinder Hole | | Slotted Button | | LED | |
| Turn-Snib | | Disabled | | Indicating Slotted Button | |

D Handle Selections

| | | | | |
|-----------------------|-------------|-------------|-------------|-------------|
| | | | | |
| 17.5mm Handle Centres | P1 108mm | P2 152mm | P3 203mm | P4 250mm |

Push and Pull Door Furniture

216/217 Series 10mm Radius Corner Push and Pull Plates

Application

The 216 Series Door Furniture is 300 x 65 x 2mm thick stainless steel or brass plate with 10mm radius corners. Concealed fixed plates have studs with internal threads located in each corner, visible plates have corresponding countersunk holes and are fixed back to back through the door.

Designed for use with Lockwood 3570 Synergy and 3P70 Pentagon Series Mortice Locks.

Compliance

 **DISABLED ACCESS – AS1428.1** ✓

Dimensions

| | |
|-------------------|--------|
| Length: | 300mm |
| Width: | 65mm |
| Thickness: | 2mm |
| Handle Diameter: | 17.5mm |
| Finger Clearance: | 40mm |

Materials

Stainless steel or brass.

Door Thickness

35 to 45mm standard. For doors 45 to 55mm thick, specify long fixing screws SP2000-208.

Finishes

| | |
|--------------------------|----|
| Satin Stainless Steel | SS |
| Polished Stainless Steel | PS |
| Powdercoat | PC |
| Polished Brass | PB |

Function/Handle Selection

Certain functions require certain handles to be used. The following table outlines which length handles (screw centre distance shown) should be used for a given function.

| Function | Description | No Engraving | With Engraving |
|----------|--|--------------|----------------|
| 24 | Pull Handle Only | P4 | P3 |
| 25 | Pull Handle and Cylinder | P2 | P2 |
| 26 | Pull Handle and Emergency Turn | P2 | P2 |
| 27 | Pull Handle and Turn Knob | P2 | P2 |
| 28 | Pull Handle and Privacy Indicator Emergency Turn | P2 | P2 |
| 29 | Pull Handle and Privacy Indicator Turn Knob | P2 | P2 |
| 30 | Pull Handle and Dual Cylinder | x | x |
| 42 | Pull Handle and Disabled Turn | P2 | P2 |
| 44 | Pull Handle Only – Offset from Bottom | P1 P2 | x |

Note: x indicates this function is not available in this configuration.





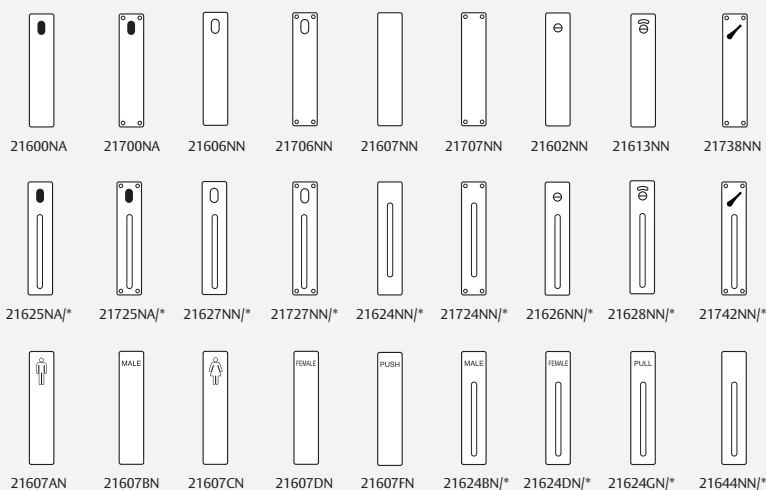

Plates



Legend

| | | | | | |
|---------------|---|----------------|---|---------------------------|---|
| Cylinder Hole |  | Slotted Button |  | LED |  |
| Turn-Snib |  | Disabled |  | Indicating Slotted Button |  |

D Handle Selections

| |  |  |  |  |
|-----------------------|--|---|---|---|
| 17.5mm Handle Centres | P1 108mm | P2 152mm | P3 203mm | P4 250mm |

Push and Pull Door Furniture

218/219 Series 10mm Radius Corner

Push and Pull Plates

Application

The 218 Series Door Furniture is 250 x 50 x 2mm thick stainless steel or brass with 10mm radius corners. Concealed fixed plates have studs with internal threads located in each corner, visible fixed plates have corresponding countersunk holes and are fixed back to back through the door.

Designed for use with Lockwood 3570 Synergy and 3P70 Pentagon Series Mortice Locks.

Compliance

DISABLED ACCESS – AS1428.1 ✓

Dimensions

| | |
|-------------------|--------|
| Length: | 250mm |
| Width: | 50mm |
| Thickness: | 2mm |
| Handle Diameter: | 17.5mm |
| Finger Clearance: | 40mm |

Materials

Stainless steel or brass.

Door Thickness

35 to 45mm standard. For doors 45 to 55mm thick, specify long fixing screws SP2000-208.

Engraving

Options are available as indicated on the right.

Finishes

| | |
|--------------------------|----|
| Satin Stainless Steel | SS |
| Polished Stainless Steel | PS |
| Powdercoat | PC |
| Polished Brass | PB |

Function/Handle Selection

Certain functions require certain handles to be used. The following table outlines which length handles (screw centre distance shown) should be used for a given function.

| Function | Description | No Engraving | With Engraving |
|----------|--|--------------|----------------|
| 24 | Pull Handle Only | P3 | P2 |
| 25 | Pull Handle and Cylinder | P1 | P1 |
| 26 | Pull Handle and Emergency Turn | P1 | P1 |
| 27 | Pull Handle and Turn Knob | P1 | P1 |
| 28 | Pull Handle and Privacy Indicator Emergency Turn | P1 | P1 |
| 29 | Pull Handle and Privacy Indicator Turn Knob | P1 | P1 |
| 30 | Pull Handle and Dual Cylinder | x | x |
| 42 | Pull Handle and Disabled Turn | P1 | P1 |
| 44 | Pull Handle Only – Offset from Bottom | P1 P2 | x |

Note: x indicates this function is not available in this configuration.

For product availability please refer to the current pricelist, contact customer service or your local sales office.

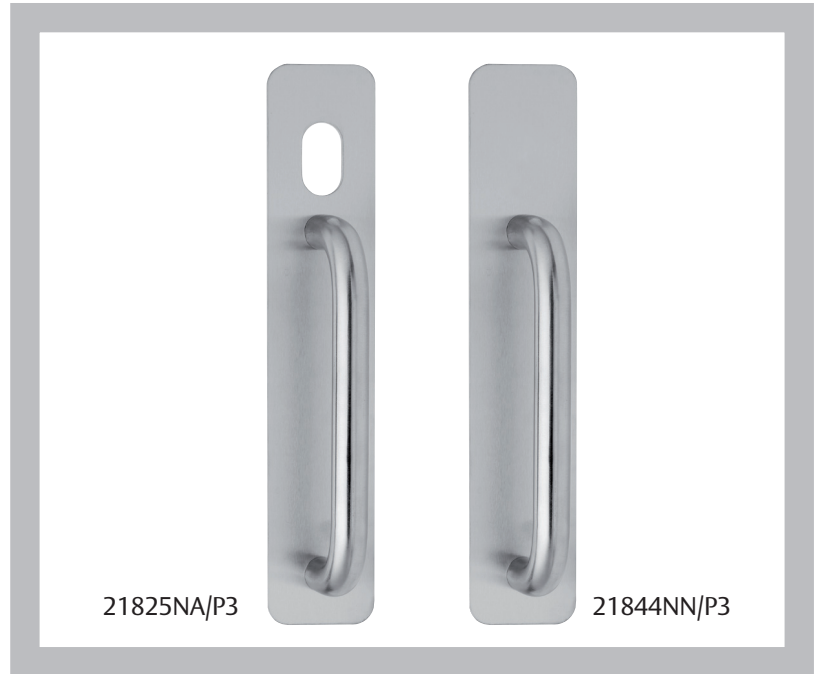

Plates

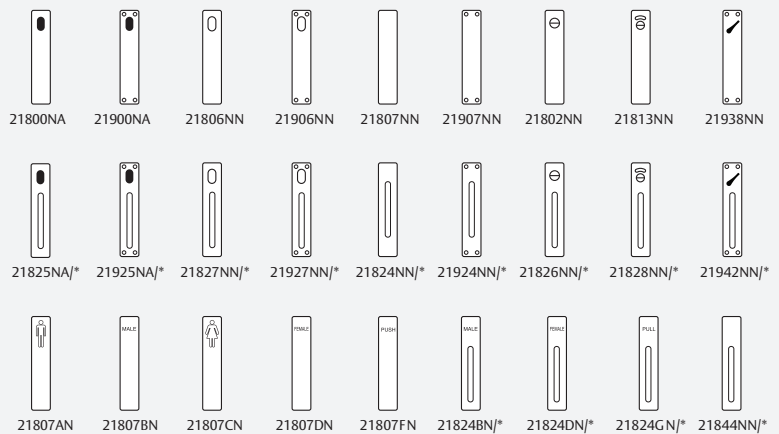

Legend

| | | | | | |
|---------------|--|----------------|--|---------------------------|--|
| Cylinder Hole | | Slotted Button | | LED | |
| Turn-Snib | | Disabled | | Indicating Slotted Button | |

D Handle Selections

| 17.5mm Handle Centres | P1 | P2 | P3 |
|-----------------------|-------|-------|-------|
| | 108mm | 152mm | 203mm |

Push and Pull Door Furniture

2000 Series Ordering Procedure

Ordering Procedure

Sample part number 21825NA/P2LSS is made up of several sections. Choose your product by selecting an option from each section.

For example:

2000 Series

| Plate Type | Plate Function | Engraving | Cylinder Shape | Handle | Handing | Finish |
|------------|----------------|-----------|----------------|--------|---------|--------|
| 218 | 25 | N | A | P2 | – | SS |

| Plate Type | Engraving | Lever/ Knob Type | Finish |
|---|---|--|--|
| Exterior Plate (300 x 100) – Radius Corners 214 | A – G Outlined Infill R – X Full Infill | Brass Pull Handles P1 P2 P3 P4 | Stainless Steel Finishes Satin Stainless Steel SS Polished Stainless Steel PS |
| Interior Plate (300 x 100) – Radius Corners 215 | Male Symbol A R Male Text B S Female Symbol C T Female Text D U Disabled Symbol E V Push Text F W Pull Text G X Unisex Symbol H Y No Option N Miscellaneous Text* P Corporate Engraving** Q | Handing Left Handed L Right Handed R | Powdercoat PC Brass Finishes Polished Brass PB |
| Exterior Plate (300 x 65) – Radius Corners 216 | | | |
| Interior Plate (300 x 65) – Radius Corners 217 | | | |
| Exterior Plate (250 x 50) – Radius Corners 218 | | | |
| Interior Plate (250 x 50) – Radius Corners 219 | | | |

| Plate Function | Cylinder Shape |
|---|--|
| Cylinder Only 00 | Oval Cylinder – 32mm (H) x 18mm (W) Lockwood 570 Cylinders A |
| Emergency Turn Only 02 | Guarded Oval Cylinder – 32mm (H) x 18mm (W) Lockwood 570 Cylinders B |
| Turn Knob Only 06 | No Cylinder Function N |
| Plain Plate 07 | Disabled Accessible Turn Only - Pentagon P |
| Dual Cylinder 10 | |
| Privacy Indicator Emergency Turn Only 13 | |
| Privacy Indicator Turn Knob Only 15 | |
| Cylinder and LED 23 | |
| Pull Handle Only 24 | |
| Pull Handle and Cylinder 25 | |
| Pull Handle and Emergency Turn 26 | |
| Pull Handle and Turn Knob 27 | |
| Pull Handle and Privacy Indicator Emergency Turn 28 | |
| Pull Handle and Privacy Indicator Turn Knob 29 | |
| Pull Handle and Dual Cylinder 30 | |
| Disabled Turn Only - Synergy 38 | |
| Pull Handle and Disabled Turn Only - Synergy 42 | |

Push and Pull Door Furniture

Pull Handles



ASSA ABLOY

All pull handles are designed for single handle application and can be used with Lockwood Pull Plates and Roses.

Features and Specifications

AS14281.1 Compliance

Fixing

Handles are concealed fixed. If ordered with Lockwood Pull Plates or Roses, handles are screw fixed to plates.

Materials

Brass and stainless steel.



Image for illustration only

Limiting Dimensions

| Handle Number | Length | Diameter | Projection | Fixing Centres | Finger Clearance | Brass | Stainless Steel | Old Handle |
|---------------|--------|----------|------------|----------------|------------------|-------|-----------------|------------|
| P1 | 125 | 17.5 | 54 | 108 | 40 | ✓ | ✓ | 05, 16 |
| P2 | 170 | 17.5 | 54 | 152 | 40 | ✓ | ✓ | 07, 17 |
| P3 | 220 | 17.5 | 54 | 203 | 40 | ✓ | ✓ | 08, 18 |
| P4 | 267 | 17.5 | 54 | 250 | 40 | ✓ | ✓ | 19 |
| B2 | 170 | 17.5 | 49 | 152 | 43 | ✓ | - | 07, 17 |
| B3 | 220 | 17.5 | 49 | 203 | 43 | ✓ | - | 08, 18 |
| B4 | 267 | 17.5 | 49 | 250 | 43 | ✓ | - | 19 |

Limiting Dimensions

| Handle Number | Length | Diameter | Projection | Fixing Centres | Finger Clearance |
|---------------|--------|----------|------------|----------------|------------------|
| 38 | 248 | 16 | Base: 54 | 152 | 38 |
| Top: 73 | | | | | |

Designed for single handle applications for hospitals, disabled and aged care facilities. Material -solid brass.



Push and Pull Door Furniture

Lockwood Entrance Handles

Lockwood Entrance Handles are constructed using the finest materials to incorporate the maximum standards in style, durability, finish and design.

Style and Variety

Combining fit for purpose with the epitome of style, the Lockwood Entrance Handles range represents a comprehensive collection of high quality back to back handles.

Nine designs, ranging from classic to contemporary, have been selected to complement the evolving style requirements of both residential and commercial markets.

Stainless Steel Construction

Constructed of 304 grade stainless steel, Lockwood Entrance Handles are suitable for use in external environments.

Application

Lockwood Entrance Handles are suitable for use on timber or aluminium frame as well as glass doors; making them the ideal choice for commercial, industrial and residential applications.

Multi Fix - timber, aluminium or glass doors

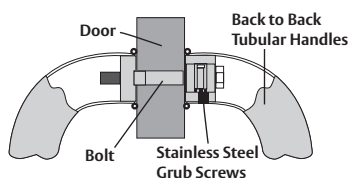

Packaging For Various Doors

Each Lockwood Entrance Handle comes supplied with spigots to suit 10 – 12mm thick glass doors as well as aluminium and timber doors up to 50mm thick.

Standard Finish

Satin Stainless Steel

SSS



Push and Pull Door Furniture

Lockwood Entrance Handles



ASSA ABLOY

141

Dimensions:

| | A | B1 | B2 | C | D | E |
|-------------|-------|------|------|------|-------|------|
| 141X300SSS | 300mm | 22mm | 40mm | 45mm | 450mm | 25mm |
| 141X450SSS | 450mm | 22mm | 40mm | 45mm | 600mm | 25mm |
| 141X600SSS* | 600mm | 22mm | 40mm | 45mm | 750mm | 25mm |

* Pictured

Fixing:

Timber 2 x 80mm M8 Bolts - 8.5mm hole

Glass 2 x 40mm M8 Bolts - 13mm hole

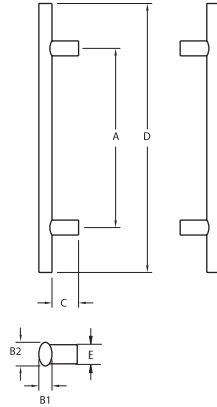

142

Dimensions:

| | A | B | C | D | E |
|-------------|-------|------|------|-------|------|
| 142X300SSS | 300mm | 32mm | 45mm | 450mm | 25mm |
| 142X450SSS | 450mm | 32mm | 45mm | 600mm | 25mm |
| 142X600SSS* | 600mm | 32mm | 45mm | 750mm | 25mm |

* Pictured

Fixing:

Timber 2 x 80mm M8 Bolts - 8.5mm hole

Glass 2 x 40mm M8 Bolts - 13mm hole

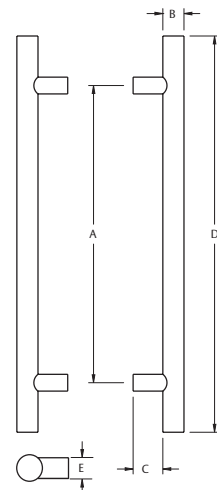

143

Dimensions:

| | A | B1 | B2 | C | D |
|-------------|-------|------|------|------|-------|
| 143X300SSS | 300mm | 30mm | 15mm | 35mm | 315mm |
| 143X450SSS | 450mm | 30mm | 15mm | 35mm | 465mm |
| 143X600SSS* | 600mm | 30mm | 15mm | 35mm | 615mm |

* Pictured

Fixing:

Timber 2 x 62mm M6 Bolts - 8.5mm hole

Glass 2 x 32mm M6 Bolts - 13mm hole

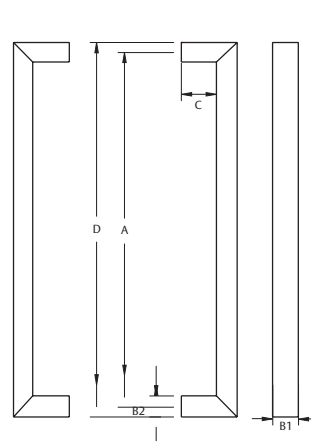

Push and Pull Door Furniture

Lockwood Entrance Handles

145

Dimensions:

| | A | B | C | D | E |
|-------------|-------|------|------|-------|------|
| 145X225SSS | 225mm | 25mm | 45mm | 300mm | 19mm |
| 145X375SSS | 375mm | 25mm | 45mm | 450mm | 19mm |
| 145X525SSS* | 525mm | 25mm | 45mm | 600mm | 19mm |

* Pictured

Fixing:

| | |
|---------------|--------------------------------|
| Timber | 2 x 70mm M8 Bolts - 8.5mm hole |
| Glass | 2 x 30mm M8 Bolts - 13mm hole |

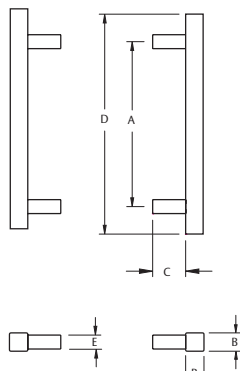

146

Dimensions:

| | A | B | C | D | E | F |
|-------------|-------|------|------|-------|------|------|
| 146X450SSS | 450mm | 25mm | 60mm | 475mm | 60mm | 25mm |
| 146X600SSS* | 600mm | 25mm | 60mm | 625mm | 60mm | 25mm |

* Pictured

Fixing:

| | |
|---------------|--------------------------------|
| Timber | 2 x 80mm M8 Bolts - 8.5mm hole |
| Glass | 2 x 40mm M8 Bolts - 13mm hole |

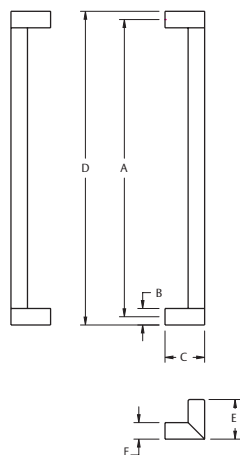

147

Dimensions:

| | A | B | C | D | E |
|------------|-------|------|------|-------|------|
| 147X450SSS | 450mm | 19mm | 45mm | 600mm | 19mm |

Fixing:

| | |
|---------------|--------------------------------|
| Timber | 2 x 62mm M8 Bolts - 8.5mm hole |
| Glass | 2 x 32mm M8 Bolts - 13mm hole |

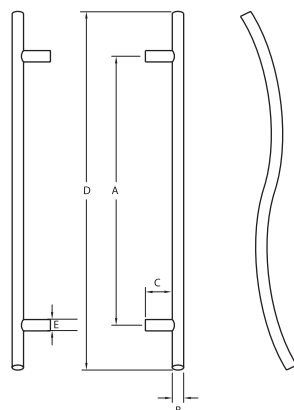

Push and Pull Door Furniture

Lockwood Entrance Handles

151

Dimensions:

| | A | B | C | D | E |
|-------------|-------|------|------|-------|-------|
| 151X3000SSS | 300mm | 32mm | 80mm | 332mm | 200mm |

Fixing:

| | |
|--------|--------------------------------|
| Timber | 2 x 80mm M8 Bolts - 8.5mm hole |
| Glass | 2 x 40mm M8 Bolts - 13mm hole |

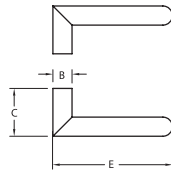
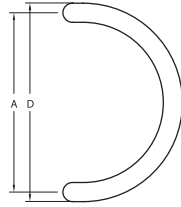

192

Dimensions:

| | A | B | C | D |
|------------|-------|------|------|-------|
| 192X450SSS | 450mm | 32mm | 85mm | 482mm |
| 192X600SSS | 600mm | 32mm | 85mm | 632mm |

Fixing:

| | |
|--------|--------------------------------|
| Timber | 2 x 80mm M8 Bolts - 8.5mm hole |
| Glass | 2 x 40mm M8 Bolts - 13mm hole |

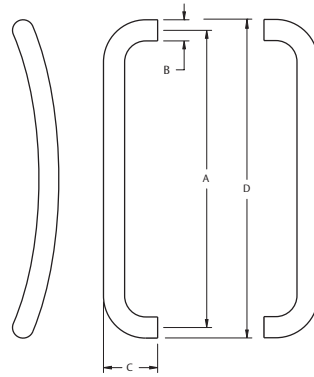

231

Dimensions:

| | A | B | C | D | E |
|-------------|-------|------|------|-------|-------|
| 231X3000SSS | 300mm | 32mm | 85mm | 332mm | 140mm |

Fixing:

| | |
|--------|--------------------------------|
| Timber | 2 x 80mm M8 Bolts - 8.5mm hole |
| Glass | 2 x 40mm M8 Bolts - 13mm hole |

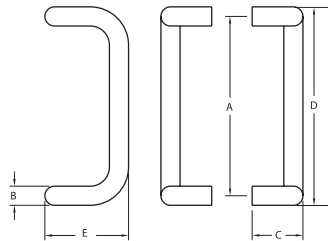

Push and Pull Door Furniture

Lockwood Entrance Handles Ordering Procedure

Ordering Procedure

Sample part number 141X300SSS is made up of several sections. Choose your product by selecting an option from each section.

For example:

| | | | |
|---------------|---|-------------------------|---------------|
| Design | | Centre to Centre | Finish |
| 141 | X | 300 | SSS |

| Design | |
|-----------|-----|
| 141 Style | 141 |
| 142 Style | 142 |
| 143 Style | 143 |
| 145 Style | 145 |
| 146 Style | 146 |
| 147 Style | 147 |
| 151 Style | 151 |
| 192 Style | 192 |
| 231 Style | 231 |

| Finish | |
|-----------------------|-----|
| Satin Stainless Steel | SSS |

| Centre to Centre | |
|---|-----|
| 300mm Centres 141, 142, 143, 151, 231 | 300 |
| 450mm Centres 141, 142, 143, 146, 147, 192 | 450 |
| 600mm Centres 141, 142, 143, 146, 192 | 600 |
| 225mm Centres (145 Style Only) | 225 |
| 375mm Centres (145 Style Only) | 375 |
| 525mm Centres (145 Style Only) | 525 |



Push and Pull Door Furniture Flush Pulls



ASSA ABLOY

Features and Specifications

- Zinc alloy cast flush pulls
- Available in a range of three sizes and three finishes
- Display packed, complete with fixing screws



| Product | Dimensions | Finishes | Packaging | Part Number |
|---------|------------|----------------------|--------------|-------------|
| L609 | 85 x 30mm | Chrome Plate | Display pack | L609CPDP |
| | | Polished Brass Plate | Display pack | L609PBPD |
| | | Satin Chrome Pearl | Display pack | L609SPDP |

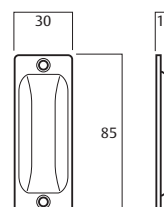

| Product | Dimensions | Finishes | Packaging | Part Number |
|---------|------------|----------------------|--------------|-------------|
| L611 | 115 x 35mm | Chrome Plate | Display pack | L611CPDP |
| | | Polished Brass Plate | Display pack | L611PBPD |
| | | Satin Chrome Pearl | Display pack | L611SPDP |

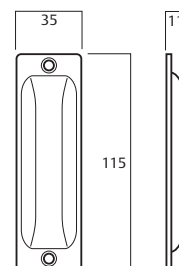

| Product | Dimensions | Finishes | Packaging | Part Number |
|---------|------------|----------------------|--------------|-------------|
| L610 | 145 x 40mm | Chrome Plate | Display pack | L610CPDP |
| | | Polished Brass Plate | Display pack | L610PBPD |
| | | Satin Chrome Pearl | Display pack | L610SPDP |

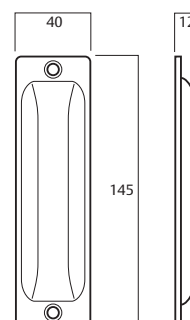

Push and Pull Door Furniture Handles

Cast Brass Handle

- Cast brass handle, visible fixing
- Display packed, complete with fixing screws

| Product | Length | Finishes | Packaging | Part Number |
|---------|--------|--------------------|--------------|-------------|
| L9-150 | 150mm | Chrome Plate | Display pack | L9-150CPDP |
| | | Satin Chrome Pearl | Display pack | L9-150SPDP |



Extruded Brass Handle

- Extruded brass handle, concealed fixing
- Display packed, complete with fixing screws

| Product | Length | Finishes | Packaging | Part Number |
|---------|--------|--------------------|--------------|-------------|
| L70 | 100mm | Satin Chrome Pearl | Display pack | L70SPDP |



ASSA ABLOY is the global leader in door opening solutions, dedicated to satisfying end-user needs for security, safety and convenience



ASSA ABLOY



Lockwood is the leading brand in the Australian locking industry. With an established reputation for high quality products, this iconic brand provides a wide range of locking solutions to residential housing, commercial building and industrial application markets. Lockwood is supported by an extensive distribution and after-sales support network. Our customers include retailers, architects, trade and industrial personnel, locksmiths and security dealers.

ASSA ABLOY

ASSA ABLOY is the global leader in door opening solutions, dedicated to satisfying end-user needs for security, safety and convenience.

ASSA ABLOY is represented in all major regions, in both mature and emerging markets, with leading positions in Australia, Europe and North America.

As the world's leading lock group, ASSA ABLOY offers a more complete product range of door opening solutions than any other company in the market.

Australia
1300 LOCK UP (1300 562 587)
lockweb.com.au

New Zealand
Telephone +64 9415 7111
assaabloy.co.nz

ASSA ABLOY Australia Pty Ltd
235 Huntingdale Road
Oakleigh, Victoria, 3166
Australia

info.au@assaabloy.com
assaabloy.com.au

ASSA ABLOY New Zealand Ltd
6 Armstrong Road
Albany, North Shore City, 0632
New Zealand

info.nz@assaabloy.com
assaabloy.co.nz

